

**AWG7000C Series  
Arbitrary Waveform Generators  
Specifications and Performance Verification  
Technical Reference**



077-0456-03



**AWG7000C Series  
Arbitrary Waveform Generators  
Specifications and Performance Verification  
Technical Reference**

**Warning**

The servicing instructions are for use by qualified personnel only. To avoid personal injury, do not perform any servicing unless you are qualified to do so. Refer to all safety summaries before performing service.

[www.tektronix.com](http://www.tektronix.com)

077-0456-03

**Tektronix**

Copyright © Tektronix. All rights reserved. Licensed software products are owned by Tektronix or its subsidiaries or suppliers, and are protected by national copyright laws and international treaty provisions.

Tektronix products are covered by U.S. and foreign patents, issued and pending. Information in this publication supersedes that in all previously published material. Specifications and price change privileges reserved.

TEKTRONIX and TEK are registered trademarks of Tektronix, Inc.

TekLink is a trademark of Tektronix, Inc.

## **Contacting Tektronix**

Tektronix, Inc.  
14150 SW Karl Braun Drive  
P.O. Box 500  
Beaverton, OR 97077  
USA

For product information, sales, service, and technical support:

- In North America, call 1-800-833-9200.
- Worldwide, visit [www.tektronix.com](http://www.tektronix.com) to find contacts in your area.

## Warranty

Tektronix warrants that this product will be free from defects in materials and workmanship for a period of one (1) year from the date of shipment. If any such product proves defective during this warranty period, Tektronix, at its option, either will repair the defective product without charge for parts and labor, or will provide a replacement in exchange for the defective product. Parts, modules and replacement products used by Tektronix for warranty work may be new or reconditioned to like new performance. All replaced parts, modules and products become the property of Tektronix.

In order to obtain service under this warranty, Customer must notify Tektronix of the defect before the expiration of the warranty period and make suitable arrangements for the performance of service. Customer shall be responsible for packaging and shipping the defective product to the service center designated by Tektronix, with shipping charges prepaid. Tektronix shall pay for the return of the product to Customer if the shipment is to a location within the country in which the Tektronix service center is located. Customer shall be responsible for paying all shipping charges, duties, taxes, and any other charges for products returned to any other locations.

This warranty shall not apply to any defect, failure or damage caused by improper use or improper or inadequate maintenance and care. Tektronix shall not be obligated to furnish service under this warranty a) to repair damage resulting from attempts by personnel other than Tektronix representatives to install, repair or service the product; b) to repair damage resulting from improper use or connection to incompatible equipment; c) to repair any damage or malfunction caused by the use of non-Tektronix supplies; or d) to service a product that has been modified or integrated with other products when the effect of such modification or integration increases the time or difficulty of servicing the product.

THIS WARRANTY IS GIVEN BY TEKTRONIX WITH RESPECT TO THE PRODUCT IN LIEU OF ANY OTHER WARRANTIES, EXPRESS OR IMPLIED. TEKTRONIX AND ITS VENDORS DISCLAIM ANY IMPLIED WARRANTIES OF MERCHANTABILITY OR FITNESS FOR A PARTICULAR PURPOSE. TEKTRONIX' RESPONSIBILITY TO REPAIR OR REPLACE DEFECTIVE PRODUCTS IS THE SOLE AND EXCLUSIVE REMEDY PROVIDED TO THE CUSTOMER FOR BREACH OF THIS WARRANTY. TEKTRONIX AND ITS VENDORS WILL NOT BE LIABLE FOR ANY INDIRECT, SPECIAL, INCIDENTAL, OR CONSEQUENTIAL DAMAGES IRRESPECTIVE OF WHETHER TEKTRONIX OR THE VENDOR HAS ADVANCE NOTICE OF THE POSSIBILITY OF SUCH DAMAGES.

[W2 – 15AUG04]



---

# Table of Contents

General Safety Summary .....	iv
Service Safety Summary .....	vi
Preface .....	vii
Related Documents .....	vii
Specifications .....	1
Performance Conditions .....	1
Electrical Specifications .....	2
Mechanical (Physical) Characteristics .....	15
Environmental Characteristics .....	16
Performance Verification Procedures .....	17
Brief Procedures .....	18
Diagnostics .....	18
Calibration .....	19
Functional Test .....	20
Performance Tests .....	23
Prerequisites .....	23
Required Equipment .....	23
Test Record .....	25
10 MHz Reference Frequency Accuracy .....	33
Analog Offset Accuracy .....	34
Analog Amplitude Accuracy .....	36
Analog Harmonic Distortion .....	39
Analog Non-Harmonic Spurious Signal .....	41
Analog Phase Noise .....	43
Marker High and Low Level Accuracy .....	45
Marker Output Delay Accuracy .....	48
DC Output Voltage Accuracy .....	50

## List of Figures

Figure 1: Diagnostics dialog box .....	18
Figure 2: Calibration dialog box .....	19
Figure 3: Equipment connections for checking the analog and marker outputs .....	21
Figure 4: Output waveform from the Analog, Mkr 1, and Mkr 2 connectors .....	22
Figure 5: Equipment connection for verifying the 10 MHz reference frequency accuracy .....	33
Figure 6: Equipment connection for measuring the termination resistance .....	34
Figure 7: Equipment connection for verifying the analog offset accuracy .....	35
Figure 8: Equipment connections for verifying the analog harmonic distortion .....	39
Figure 9: Equipment connections for verifying the non-harmonic spurious signal .....	41
Figure 10: Equipment connections for verifying the analog phase noise .....	43
Figure 11: Example of the analog phase noise measurement .....	45
Figure 12: Equipment connection for verifying the marker high and low level accuracy .....	46
Figure 13: Equipment connections for verifying the marker output delay accuracy .....	49
Figure 14: Equipment connection for verifying the DC output voltage accuracy .....	51



## List of Tables

Table 1: Run mode .....	2
Table 2: Arbitrary waveform .....	2
Table 3: Clock generator.....	3
Table 4: Trigger generator .....	4
Table 5: Inter-channel skew control .....	4
Table 6: Interleave adjustment (Option 06).....	4
Table 7: Waveform rotation control for analog output .....	5
Table 8: Analog output (Standard) .....	5
Table 9: Analog output (Option 02 and 06) .....	7
Table 10: Interleave analog output (Option 06).....	8
Table 11: Marker output .....	9
Table 12: Trigger and gate input.....	10
Table 13: Event input .....	11
Table 14: Reference clock input .....	12
Table 15: Oscillator (External clock) input.....	12
Table 16: DC output.....	12
Table 17: Dynamic Jump In connector.....	13
Table 18: Synchronization clock out port.....	14
Table 19: 10 MHz clock output.....	14
Table 20: TekLink port.....	14
Table 21: CPU module and peripheral devices.....	14
Table 22: Display .....	15
Table 23: Power supply .....	15
Table 24: Mechanical characteristics.....	15
Table 25: Environmental characteristics .....	16
Table 26: Required equipment .....	23
Table 27: Test waveforms .....	24
Table 28: Analog offset accuracy .....	35
Table 29: Analog amplitude accuracy.....	37
Table 30: Analog harmonic distortion.....	40
Table 31: Analog non-harmonic spurious signal.....	42
Table 32: Analog phase noise .....	44
Table 33: Marker High and Low level accuracy .....	46
Table 34: DC output voltage accuracy .....	51

## General Safety Summary

Review the following safety precautions to avoid injury and prevent damage to this product or any products connected to it.

To avoid potential hazards, use this product only as specified.

*Only qualified personnel should perform service procedures.*

### To Avoid Fire or Personal Injury

**Use proper power cord.** Use only the power cord specified for this product and certified for the country of use.

**Ground the product.** This product is grounded through the grounding conductor of the power cord. To avoid electric shock, the grounding conductor must be connected to earth ground. Before making connections to the input or output terminals of the product, ensure that the product is properly grounded.

**Observe all terminal ratings.** To avoid fire or shock hazard, observe all ratings and markings on the product. Consult the product manual for further ratings information before making connections to the product.

Do not apply a potential to any terminal, including the common terminal, that exceeds the maximum rating of that terminal.

**Power disconnect.** The power cord disconnects the product from the power source. Do not block the power cord; it must remain accessible to the user at all times.

**Do not operate without covers.** Do not operate this product with covers or panels removed.

**Do not operate with suspected failures.** If you suspect that there is damage to this product, have it inspected by qualified service personnel.

**Avoid exposed circuitry.** Do not touch exposed connections and components when power is present.

**Do not operate in wet/damp conditions.**

**Do not operate in an explosive atmosphere.**

**Keep product surfaces clean and dry.**

**Provide proper ventilation.** Refer to the manual's installation instructions for details on installing the product so it has proper ventilation.

**Terms in This Manual** These terms may appear in this manual:



**WARNING.** *Warning statements identify conditions or practices that could result in injury or loss of life.*



**CAUTION.** *Caution statements identify conditions or practices that could result in damage to this product or other property.*

**Symbols and Terms on the Product**

These terms may appear on the product:

- DANGER indicates an injury hazard immediately accessible as you read the marking.
- WARNING indicates an injury hazard not immediately accessible as you read the marking.
- CAUTION indicates a hazard to property including the product.

The following symbol(s) may appear on the product:



## Service Safety Summary

Only qualified personnel should perform service procedures. Read this *Service Safety Summary* and the *General Safety Summary* before performing any service procedures.

**Do Not Service Alone.** Do not perform internal service or adjustments of this product unless another person capable of rendering first aid and resuscitation is present.

**Disconnect Power.** To avoid electric shock, switch off the instrument power, then disconnect the power cord from the mains power.

**Use Care When Servicing With Power On.** Dangerous voltages or currents may exist in this product. Disconnect power, remove battery (if applicable), and disconnect test leads before removing protective panels, soldering, or replacing components.

To avoid electric shock, do not touch exposed connections.

---

# Preface

This manual contains specifications and performance verification procedures for the AWG7000C Series Arbitrary Waveform Generators.

## Related Documents

The following user documents are also available for this product:

- *AWG5000 and AWG7000 Series Arbitrary Waveform Generators Quick Start User Manual*. This document describes the functions and use of the instrument.
- *AWG7000 Series Arbitrary Waveform Generators Service Manual*. This is a PDF only manual that provides module-level service information. It can be downloaded from the Tektronix Web site.



---

# Specifications

This section contains the specifications for the instruments.

All specifications are guaranteed unless noted as *(Typical)*. Typical specifications are provided for your convenience but are not guaranteed. Specifications that are marked with the ✓ symbol are checked in this manual.

## Performance Conditions

To meet specifications, the following conditions must be met:

- The instrument must have been calibrated/adjusted at an ambient temperature between +20 °C and +30 °C.
- The instrument must be operating within the environmental limits. (See Table 25 on page 16.)
- The instrument must be powered from a source that meets the specifications. (See Table 23 on page 15.)
- The instrument must have been operating continuously for at least 20 minutes within the specified operating temperature range.

## Electrical Specifications

**Table 1: Run mode**

Characteristics	Description
Continuous mode	An arbitrary waveform is output continuously.
Triggered mode	An arbitrary waveform is output only once when a trigger signal is applied. After the waveform is output, the instrument waits for the next trigger signal.
Gated mode	An arbitrary waveform is output only when a gate signal is asserted. The waveform output is repeated while the gate signal stays asserted. When the gate signal is deasserted, the waveform output stops immediately.
Sequence mode	
Without Option 08	Sequence switching with wait trigger
Option 08	Fast sequence switching

**Table 2: Arbitrary waveform**

Characteristics	Description
Waveform length	
Without Option 01	1 to 32,400,000 points (Interleave is off) 2 to 64,800,000 points (Option 06, Interleave is on)
With Option 01	1 to 64,800,000 points (Interleave is off) 2 to 129,600,000 points (Interleave is on)
Hardware limitation	960 points minimum (Interleave is off) 1920 points minimum (Option 06, Interleave is on)
Waveform granularity	1 point
Hardware limitation	4 points (AWG7082C, AWG7122C) 8 points (AWG7082C, AWG7122C Option 06, Interleave on)
DAC resolution	10 bits or 8 bits selectable (when the 10 bits DAC mode is selected, marker output is disabled.)
Number of waveforms	Up to 32,000 waveforms (predefined waveforms are not included)
Sequence length	1 to 16,000 steps
Sequence controls	
Without Option 08	Repeat count, Wait-for-Trigger (On only), Go-to-N, and Jump are available
Option 08	Repeat count, Wait-for-Trigger (On or Off), Go-to-N, and Jump are available
Repeat count	1 to 65,536 or infinite (all channels operate the same sequence)
Jump timing	Synchronous or Asynchronous selectable



**Table 2: Arbitrary waveform (cont.)**

Characteristics	Description
Sequence switching time ( <i>Typical</i> )	
AWG7000C series	8 ns (AWG7082C) 106 $\mu$ s (AWG7122C)
AWG7000C series with Option 02	8 ns (AWG7082C) 106 $\mu$ s (AWG7122C)
AWG7000C series with Option 06	160 $\mu$ s (AWG7082C) 106 $\mu$ s (AWG7122C)
AWG7000C series with Option 08	312 ps (AWG7082C) 208 ps (AWG7122C)
AWG7000C series with Option 02 and Option 08	312 ps (AWG7082C) 208 ps (AWG7122C)
AWG7000C series with Option 06 and Option 08	156 ps (AWG7082C) 104 ps (AWG7122C)

**Table 3: Clock generator**

Characteristics	Description
Sampling rate control	
Range	
AWG7122C	10 MS/s to 12 GS/s (Interleave is off)
AWG7122C with Option 06 <sup>1</sup>	12 GS/s to 24 GS/s (Interleave is on)
AWG7082C	10 MS/s to 8 GS/s (Interleave is off)
AWG7082C with Option 06 <sup>1</sup>	8 GS/s to 16 GS/s (Interleave is on)
Resolution	8 digits
✓ Internal clock frequency	Within $\pm$ (1 ppm + aging)
Internal clock frequency accuracy ( <i>Typical</i> )	Aging: within $\pm$ 1 ppm/year
✓ Reference oscillator accuracy	Within $\pm$ (1 ppm + aging)
Reference oscillator aging ( <i>Typical</i> )	Aging: within $\pm$ 1 ppm/year

<sup>1</sup> Interleaving is applied to analog output. When interleaving is on, marker data with even numbers will be output.

**Table 4: Trigger generator**

Characteristics	Description
Trigger rate <sup>1</sup>	
Range	1.0 $\mu$ s to 10.0 s
Resolution	0.1 $\mu$ s minimum
Accuracy	Same as the reference oscillator

<sup>1</sup> Trigger is ignored when all the following conditions are met:

- Instrument type: AWG7122C with Option 06, without Option 08
- Run mode: Sequence
- Interleave: On

**Table 5: Inter-channel skew control**

Characteristics	Description
Skew control	
Range	-100 ps to +100 ps
Resolution	1 ps
Skew accuracy ( <i>Typical</i> ) <sup>1</sup>	$\pm$ (10% of effective skew setting +10 ps) Direct output mode on standard instrument

<sup>1</sup> Effective skew setting is the absolute value of the difference between the skew setting on channels.

**Table 6: Interleave adjustment (Option 06)**

Characteristics	Description
Phase adjustment	
Range	-180 ° to +180 °
Resolution	0.1 °
Amplitude adjustment	At amplitude setting 0.75 $V_{p-p}$
Range <sup>1</sup>	-0.25 $V_{p-p}$ to +0.25 $V_{p-p}$
Resolution	0.001 V

<sup>1</sup> Range depends on the amplitude settings.

(Amplitude setting + Adjustment) and (Amplitude setting – Adjustment) should be within the following range:

- 0.5  $V_{p-p}$  to 1.0  $V_{p-p}$  with zeroing off
- 0.25  $V_{p-p}$  to 0.5  $V_{p-p}$  with zeroing on

**Table 7: Waveform rotation control for analog output**

Characteristics	Description
Phase control	
Range	CVR Gain stability is $\pm 0.1\%$ if measured within $25^\circ$ of the temperature at factory calibration
Resolution	CVR Gain linearity is $\pm 0.2\%$ . Perform an automatic sweep and take voltage measurements at every DAC value.
Time control	
Range	$-1/2$ period to $+1/2$ period of waveform
Resolution	0.1 ps
Point control	
Range	$-50\%$ to $+50\%$ of waveform
Resolution	0.001 points

**Table 8: Analog output (Standard)**

Characteristics	Description
Connector type	SMA on front panel
Type of output	(+) and (-) complementary output
Output impedance	50 $\Omega$
Amplitude controls	
Range	
Normal mode	50 mV to 2.0 $V_{p-p}$
Direct D/A mode	50 mV to 1.0 $V_{p-p}$
Resolution	1 mV
Offset controls	
Range	
Normal mode	$-0.5$ V to $+0.5$ V
Direct D/A mode	N/A
Resolution	1 mV
✓ Amplitude accuracy	DC accuracy: within $\pm$ (3% of amplitude + 2 mV) at offset = 0V
✓ Offset accuracy	DC accuracy: within $\pm$ (2% of amplitude + 10 mV) at minimum amplitude
Bandwidth ( <i>Typical</i> )	
Normal mode	750 MHz, at -3 dB
Direct D/A mode	3.5 GHz, at -3 dB
Rise/fall time ( <i>Typical</i> )	
Normal mode	350 ps (20% to 80%), when amplitude = 2.0 $V_{p-p}$ , offset = 0 V
Direct D/A mode	75 ps (20% to 80%), when amplitude = 1.0 $V_{p-p}$
Overshoot ( <i>Typical</i> )	< 10%, when amplitude = 1.0 $V_{p-p}$

Table 8: Analog output (Standard) (cont.)

Characteristics	Description
Low pass filter	
Normal mode	50 MHz, 200 MHz, Through (Bessel type)
Direct D/A mode	N/A
Delay from marker ( <i>Typical</i> )	10.15 ns $\pm$ 0.15 ns: low pass = 50 MHz 4.05 ns $\pm$ 0.05 ns: low pass = 200 MHz 2.26 ns $\pm$ 0.04 ns: low pass = Through 0.585 ns $\pm$ 0.045 ns: Direct output mode (when amplitude = 1.0 V <sub>p-p</sub> , offset = 0 V)
Skew between (+) and (-) outputs ( <i>Typical</i> )	< 20 ps (direct D/A mode)
ON/OFF control	Output relay is available for each channel. The control is common to the complementary output.
✓ Harmonic distortion	Amplitude = 1.0 V <sub>p-p</sub> , offset = 0 V, DAC resolution = 10 bits, measured with 32-point sine waveform, defined up to 5 <sup>th</sup> harmonic
AWG7122C Normal mode	< -35 dBc, when clock = 12 GS/s, signal = 375 MHz
AWG7122C Direct D/A mode	< -42 dBc, when clock = 12 GS/s, signal = 375 MHz
AWG7082C Normal mode	< -37 dBc, when clock = 8 GS/s, signal = 250 MHz
AWG7082C Direct D/A mode	< -43 dBc, when clock = 8 GS/s, signal = 250 MHz
✓ Non-harmonic spurious	Amplitude = 1.0 V <sub>p-p</sub> , offset = 0 V, DAC resolution = 10 bits, measured with 32-point sine waveform, measurement range is DC to sampling_frequency $\div$ 2
AWG7122C	< -50 dBc, DC to 6 GHz, when clock = 12 GS/s, signal = 375 MHz
AWG7082C	< -50 dBc, DC to 4 GHz, when clock = 8 GS/s, signal = 250 MHz
SFDR ( <i>Typical</i> )	Normal output mode, amplitude = 1.0 V <sub>p-p</sub> , offset = 0 V, DAC resolution = 10 bits, measurement range is DC to sampling_frequency $\div$ 2
AWG7122C	43 dBc, when clock = 12 GS/s, signal = 375 MHz
AWG7122C, AWG7082C	45 dBc, when clock = 8 GS/s, signal = 250 MHz
✓ Phase noise	Normal output mode, amplitude = 1.0 V <sub>p-p</sub> , offset = 0 V, DAC resolution = 10 bits, measured with 32-point sine waveform
AWG7122C	< -90 dBc/Hz at 10 kHz offset, when clock = 12 GS/s, signal = 375 MHz
AWG7082C	< -90 dBc/Hz at 10 kHz offset, when clock = 8 GS/s, signal = 250 MHz
Random jitter on clock pattern ( <i>Typical</i> )	Using 0101... clock pattern, amplitude = 1.0 V <sub>p-p</sub> , offset = 0 V
Normal mode	1.6 ps <sub>RMS</sub>
Direct D/A mode	0.45 ps <sub>RMS</sub>
Total jitter on random pattern ( <i>Typical</i> )	Using PN15 pattern, amplitude = 1.0 V <sub>p-p</sub> , offset = 0 V, measured at bit error rate = 1e <sup>-12</sup>
Normal mode	50 ps <sub>p-p</sub> at 500 MS/s
Direct D/A mode	30 ps <sub>p-p</sub> from 1 GS/s to 6 GS/s
Amplitude flatness ( <i>Typical</i> )	$\pm$ 2 db from 50 MHz to 3.5 GHz Measured with Direct Output at 50 MHz increments, mathematically corrected for sin(x)/x roll-off

Table 9: Analog output (Option 02 and 06)

Characteristics	Description
Connector type	SMA on front panel
Type of output	(+) and (-) complementary outputs
Output impedance	50 $\Omega$
Amplitude controls	
Range	0.5 V to 1.0 V <sub>p-p</sub>
Resolution	1 mV
✓ Amplitude accuracy	DC accuracy: Within $\pm$ (2% of amplitude + 2 mV) at offset = 0V
✓ DC offset	Within $\pm$ 10 mV
Bandwidth (Typical)	7.5 GHz at -3 dB
Rise/fall time (Typical)	35 ps (20% to 80%), when amplitude = 1.0 V <sub>p-p</sub>
Overshoot (Typical)	< 3%, when amplitude = 1.0 V <sub>p-p</sub>
Delay from marker (Typical)	Option 02: 0.185 ns $\pm$ 0.05 ns, when amplitude = 1.0 V <sub>p-p</sub> Option 06 1.025 ns $\pm$ 0.05 ns, when amplitude = 1.0 V <sub>p-p</sub>
Skew between (+) and (-) outputs (Typical)	< 12 ps
ON/OFF control	Output relay is available for each channel. The control is common to the complementary output.
✓ Harmonic distortion	Amplitude = 1.0 V <sub>p-p</sub> , DAC resolution = 10 bit, measured with 32-point sine waveform, defined up to 5 <sup>th</sup> harmonic
AWG7122C	< -42 dBc, when clock = 12 GS/s, signal = 375 MHz
AWG7082C	< -44 dBc, when clock = 8 GS/s, signal = 250 MHz
✓ Non-harmonic spurious	Amplitude = 1.0 V <sub>p-p</sub> , resolution = 10 bits, measured with 32-point sine waveform, measurement range is DC to sampling frequency $\div$ 2
AWG7122C	< -50 dBc, DC to 6 GHz, when clock = 12 GS/s, signal = 375 MHz
AWG7082C	< -50 dBc, DC to 4 GHz, when clock = 8 GS/s, signal = 250 MHz
SFDR (Typical)	Amplitude = 1.0 V <sub>p-p</sub> , DAC resolution = 10 bits, measurement range is DC to sampling frequency $\div$ 2 including harmonics
AWG7122C	44 dBc, when clock = 12 GS/s, signal = 375 MHz
AWG7082C	46 dBc, when clock = 8 GS/s, signal = 250 MHz
✓ Phase noise	Amplitude = 1.0 V <sub>p-p</sub> , DAC resolution = 10 bit, measured with 32 point sine waveform
AWG7122C	< -90 dBc/Hz at 10 kHz offset, when clock = 12 GS/s, signal = 375 MHz
AWG7082C	< -90 dBc/Hz at 10 kHz offset, when clock = 8 GS/s, signal = 250 MHz
Random jitter on clock pattern (Typical)	0.4 ps <sub>RMS</sub> , using 0101... clock pattern, amplitude = 1.0 V <sub>p-p</sub> , measured for five minutes
Total jitter on random pattern (Typical)	20 ps <sub>p-p</sub> from 2 GS/s to 12 GS/s, PN15 pattern, amplitude = 1.0 V <sub>p-p</sub> , measured at bit error rate = 1e <sup>-12</sup> for five minutes
Amplitude flatness (Typical)	$\pm$ 2 dB from 50 MHz to 4.8 GHz Measured at 50 MHz increments, mathematically corrected for sin(x)/x roll-off

**Table 10: Interleave analog output (Option 06)**

Characteristics	Description
Connector type	SMA on front panel
Type of output	(+) and (-) complementary output
Output impedance	50 $\Omega$
Zeroing control	Zeroing On and Off is selectable.
Amplitude controls	
Range	0.25 V to 0.5 $V_{p-p}$ , Zeroing = On 0.5 V to 1.0 $V_{p-p}$ , Zeroing = Off
Resolution	1 mV
Amplitude accuracy ( <i>Typical</i> )	DC accuracy at offset = 0 V Within $\pm$ (40% of amplitude + 2 mV), Zeroing = On Within $\pm$ (8% of amplitude + 2 mV), Zeroing = Off
✓ DC offset	Within $\pm$ 10 mV
Bandwidth ( <i>Typical</i> )	7.5 GHz at -3 dB, when amplitude = 0.5 $V_{p-p}$ , zeroing = On
Rise/fall time ( <i>Typical</i> )	35 ps (20% to 80%), when amplitude = 0.5 $V_{p-p}$ , zeroing = On
Delay from marker ( <i>Typical</i> )	0.86 ns $\pm$ 0.05 ns when amplitude = 0.5 $V_{p-p}$ , zeroing = On
Skew between (+) and (-) outputs ( <i>Typical</i> )	< 12 ps
ON/OFF control	Output relay is available for each channel. The control is common to the complementary output.
Harmonic distortion ( <i>Typical</i> )	Measured with 32-point sine waveform, defined up to 5 <sup>th</sup> harmonics
AWG7122C	
Zeroing = On	< -38 dBc, when amplitude = 0.5 $V_{p-p}$ , clock = 24 GS/s, signal = 750 MHz
Zeroing = Off	< -40 dBc, when amplitude = 1.0 $V_{p-p}$ , clock = 24 GS/s, signal = 750 MHz
AWG7082C	
Zeroing = On	< -38 dBc, when amplitude = 0.5 $V_{p-p}$ , clock = 16 GS/s, signal = 500 MHz
Zeroing = Off	< -40 dBc, when amplitude = 1.0 $V_{p-p}$ , clock = 16 GS/s, signal = 500 MHz
Non-harmonic spurious ( <i>Typical</i> )	Amplitude = 1.0 $V_{p-p}$ , DAC resolution = 10 bit, measured with 32-point sine waveform, measurement range: DC to sampling frequency $\div$ 4
AWG7122C	
Zeroing = On	< -45 dBc, DC to 6 GHz, when amplitude = 0.5 $V_{p-p}$ , clock = 24 GS/s, signal = 750 MHz
Zeroing = Off	< -45 dBc, DC to 6 GHz, when amplitude = 1.0 $V_{p-p}$ , clock = 24 GS/s, signal = 750 MHz
AWG7082C	
Zeroing = On	< -45 dBc, DC to 4 GHz, when amplitude = 0.5 $V_{p-p}$ , clock = 16 GS/s, signal = 500 MHz
Zeroing = Off	< -45 dBc, DC to 4 GHz, when amplitude = 1.0 $V_{p-p}$ , clock = 16 GS/s, signal = 500 MHz

Table 10: Interleave analog output (Option 06) (cont.)

Characteristics	Description
SFDR ( <i>Typical</i> )	Amplitude = 1.0 V <sub>p-p</sub> , DAC resolution = 10 bit, measurement range: DC to sampling frequency ÷ 2
AWG7122C	
Zeroing = On	30 dBc, when amplitude = 0.5 V <sub>p-p</sub> , clock = 24 GS/s, signal = 3 GHz
Zeroing = Off	40 dBc, when amplitude = 1.0 V <sub>p-p</sub> , clock = 24 GS/s, signal = 3 GHz
AWG7082C	
Zeroing = On	30 dBc, when amplitude = 0.5 V <sub>p-p</sub> , clock = 16 GS/s, signal = 2 GHz
Zeroing = Off	40 dBc, when amplitude = 1.0 V <sub>p-p</sub> , clock = 16 GS/s, signal = 2 GHz
✓ Phase noise	DAC resolution = 10 bit, measured with 32-point sine waveform
AWG7122C	
Zeroing = On	< -85 dBc/Hz at 10 kHz offset, when amplitude = 0.5 V <sub>p-p</sub> , clock = 24 GS/s, signal = 750 MHz
Zeroing = Off	< -85 dBc/Hz at 10 kHz offset, when amplitude = 1.0 V <sub>p-p</sub> , clock = 24 GS/s, signal = 750 MHz
AWG7082C	
Zeroing = On	< -85 dBc/Hz at 10 kHz offset, when amplitude = 0.5 V <sub>p-p</sub> , clock = 16 GS/s, signal = 500 MHz
Zeroing = Off	< -85 dBc/Hz at 10 kHz offset, when amplitude = 1.0 V <sub>p-p</sub> , clock = 16 GS/s, signal = 500 MHz
Amplitude flatness ( <i>Typical</i> )	±3 dB from 50 MHz to 9.6 GHz Measured with Zeroing ON, at 50 MHz increments, mathematically corrected for sin(x)/x roll-off

Table 11: Marker output

Characteristics	Description
Connector type	SMA on front panel
Number of outputs	Marker 1 and Marker 2 are available for each channel.
Type of output	(+) and (-) complementary output
Output impedance	50 Ω
Level controls	Output voltage into RLOAD(Ω) to GND is approximately $(2 \times RLOAD \div (50 + RLOAD)) \times$ voltage setting
Voltage window	-1.4 V to +1.4 V into 50 Ω
Amplitude	0.5 V <sub>p-p</sub> to 1.4 V <sub>p-p</sub> into 50 Ω
Resolution	0.01 V
External termination	When an external termination is used the termination voltage should be within -2.8 V to +2.8 V
✓ Level accuracy	DC accuracy: ± (10% of  setting  + 75 mV) into 50 Ω
Output current	± 28 mA max
Variable delay control	Available for Marker 1 and Marker 2
Range	0 to 300 ps
Resolution	1 ps
✓ Variable delay accuracy	± (5% of setting + 50 ps)
Rise/fall time ( <i>Typical</i> )	45 ps (20% to 80% of swing), when Hi = 1.0 V, Low = 0 V

**Table 11: Marker output (cont.)**

Characteristics	Description
Random jitter on clock pattern ( <i>Typical</i> )	1 ps <sub>RMS</sub> (using 0101... clock pattern), when Hi = 1.0 V, Low = 0 V
Total jitter on random pattern ( <i>Typical</i> )	30 ps <sub>p-p</sub> (using PN15 pattern, when Hi = 1.0 V, Low = 0 V, measured at bit error rate = 1e <sup>-12</sup> )
Skew between (+) and (-) outputs ( <i>Typical</i> )	< 13 ps
Skew between Marker 1 and Marker 2 ( <i>Typical</i> )	< 30 ps
Aberrations ( <i>Typical</i> )	
High speed	< ±20% <sub>p-p</sub> for the first 1 ns following the step transition with 100% reference at 4 ns, for an ambient temperature range of 20 °C to 30 °C (68 °F to 86 °F)
Long term	< ±5% <sub>p-p</sub> after 1 ns to 4 ns following the step transition with 100% reference at 4 ns, for an ambient temperature range of 20 °C to 30 °C (68 °F to 86 °F)

**Table 12: Trigger and gate input**

Characteristics	Description
Connector	BNC on front panel
Input impedance	1 kΩ or 50 Ω selectable
Polarity	Positive or negative selectable
Input voltage range	
When 1 kΩ selected	-10 V to 10 V
When 50 Ω selected	< 5 V <sub>RMS</sub>
Threshold control	
Level	-5.0 V to 5.0 V
Resolution	0.1 V
Accuracy ( <i>Typical</i> )	± (5% of  setting  + 0.1 V)
Input voltage swing ( <i>Typical</i> )	0.5 V <sub>p-p</sub> minimum
Minimum pulse width	
Triggered mode	20 ns
Gated mode	1024 × sampling period + 210 ns
Trigger delay to analog output ( <i>Typical</i> )	128 × sampling period + 250 ns
Trigger hold off ( <i>Typical</i> )	832 × sampling period – 100 ns
Gate delay to analog output ( <i>Typical</i> )	640 × sampling period + 260 ns



Table 12: Trigger and gate input (cont.)

Characteristics	Description
Trigger jitter ( <i>Typical</i> )	0.7 ns at 12 GS/s 0.8 ns at 9 GS/s 1.0 ns at 6 GS/s
Synchronized between external clock and trigger timing	12 GS/s, x 1 clock divider, synchronous trigger mode with specific timing: 50 ps <sub>p-p</sub> , 10 ps <sub>RMS</sub>
Synchronized between external 10 MHz reference and trigger timing	12 GS/s setting, synchronous trigger mode with specific timing: 120 ps <sub>p-p</sub> , 30 ps <sub>RMS</sub>
Synchronized between external variable reference and trigger timing	2 <sup>N</sup> (N: integer) Clock setting of reference, synchronous trigger mode with specific timing: 50 ps <sub>p-p</sub> , 10 ps <sub>RMS</sub>
Trigger timing	Selectable synchronous mode or asynchronous mode, settable only through the program interface.

Table 13: Event input

Characteristics	Description
Connector type	BNC on front panel
Input impedance	1 kΩ or 50 Ω selectable
Polarity	Positive or negative selectable
Input voltage range	
When 1 kΩ selected	–10 V to 10 V
When 50 Ω selected	< 5 V <sub>RMS</sub>
Threshold control	
Level	–5.0 V to 5.0 V
Resolution	0.1 V
Accuracy ( <i>Typical</i> )	± (5% of  setting  + 0.1 V)
Input voltage swing ( <i>Typical</i> )	0.5 V <sub>p-p</sub> minimum
Minimum pulse width	20 ns
Delay to analog output ( <i>Typical</i> )	When asynchronous jump 1024 × sampling period + 280 ns
Hold off time ( <i>Typical</i> )	When hardware sequencer is used 900 × sampling period + 150 ns

**Table 14: Reference clock input**

Characteristics	Description
Connector type	BNC on rear panel
Input impedance	50 $\Omega$ (AC coupled)
Input voltage swing	0.2 V <sub>p-p</sub> to 3 V <sub>p-p</sub>
Fixed mode input frequency	10 MHz, 20 MHz, and 100 MHz within $\pm 0.1\%$
Variable mode input frequency range	10 MHz to 800 MHz Acceptable frequency drift while the instrument is operating: $\pm 0.1\%$ Frequency should be stable
Variable mode multiplier rate	The rate value is limited by sampling rate range.
AWG7122C without interleave	1 to 2400
AWG7122C with interleave	2 to 4800
AWG7082C without interleave	1 to 1600
AWG7082C with interleave	2 to 3200

**Table 15: Oscillator (External clock) input**

Characteristics	Description
Connector type	SMA on rear panel
Input impedance	50 $\Omega$ (AC coupled)
Frequency range	6.0 GHz to 12.0 GHz Frequency should be stable. Acceptable frequency drift while running is $\pm 0.1\%$ .
Input power range	+7 dBm to +10 dBm
Divider	1/1, 1/2, 1/4, 1/8, ... , 1/256

**Table 16: DC output**

Characteristics	Description
Connector type	2 x 4 pin header, 2.54 mm pitch (female) on front panel
Number of outputs	4
Output voltage control	
Range	-3.0 V to +5.0 V
Resolution	10 mV
Control	Independent for each output
✓ Output voltage accuracy	$\pm (3\% \text{ of }  \text{setting}  + 120 \text{ mV})$ into High-Z load
Output current	$\pm 100 \text{ mA}$ maximum
Output impedance ( <i>Typical</i> )	1 $\Omega$

Table 17: Dynamic Jump In connector

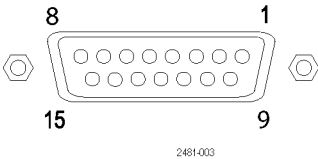
Characteristics	Description
Function	Allows fast switching during table jump and subsequence
Connector type	15-pin D-sub female connector on rear panel
Input signal & pin assignment	 <p style="text-align: center; font-size: small;">2481-003</p>
<i>Pin</i>	<i>Signal and direction</i>
1	GND
2	Jump bit 0, input
3	Jump bit 1, input
4	Jump bit 2, input
5	Jump bit 3, input
6	GND
7	Strobe, input
8	GND
9	GND
10	Jump bit 4, input
11	Jump bit 5, input
12	Jump bit 6, input
13	Jump bit 7, input
14	GND
15	GND
Input levels	TTL = 5 V compliant inputs 3.33 V LV CMOS level
Input impedance	Pull up to 3.3 V by 1 kΩ resistor
Number of dynamic jump destinations	256 Maximum sequence indices The flag that decides whether or not the event input pattern is valid can be set to each of the patterns.
Strobe	Must Strobe jump destination

**Table 18: Synchronization clock out port**

Characteristics	Description
Connector type	SMA on rear panel
Output impedance	50 $\Omega$ (AC coupled)
Amplitude ( <i>Typical</i> )	1 V <sub>p-p</sub> into 50 $\Omega$

**Table 19: 10 MHz clock output**

Characteristics	Description
Connector type	BNC
Output impedance	50 $\Omega$ (AC coupled)
Amplitude ( <i>Typical</i> )	1.2 V <sub>p-p</sub> into 50 $\Omega$ 2.4 V <sub>p-p</sub> into 1 M $\Omega$

**Table 20: TekLink port**

Characteristics	Description
Function	Provides a TekLink interface that complies with Tektronix TekLink 2.0 specification. The instrument operates in slave mode only.
Connector type	40-pin connector on rear panel

**Table 21: CPU module and peripheral devices**

Characteristics	Description
CPU	Intel core duo processor
Memory	4 GB DDR2-800 or faster
Solid state hard disk drive	$\geq$ 300 GB, usable area is about 90%
Hard disk drive	$\geq$ 1 TB, usable area is about 90%
Optical disk drive	CD-RW/DVD drive, writing software not included
USB 2.0	6 (2 x front, 4 x rear)
LAN	RJ-45 LAN connector supporting 10 base-T, 100 base-T, and Gigabit Ethernet on rear panel
ESATA	External ESATA at $\geq$ 1.5 Gbps
Video output	DV/I connector
GPIB	IEEE 488.2 standard interface, 24 pins
PS2 keyboard connector	6 pins, mini-DIN
PS2 mouse connector	6 pins, mini-DIN
Serial ports	Two RS-232C, D-sub, 9 pins

**Table 22: Display**

Characteristics	Description
Size	210 mm X 158 mm (8.28 in X 6.22 in)
Resolution	1024 X 768 pixels
Touch screen	Built-in touch screen

**Table 23: Power supply**

Characteristics	Description
Source voltage and frequency	
Rating voltage	100 V <sub>AC</sub> to 240 V <sub>AC</sub>
Frequency range	47 Hz to 63 Hz
Power consumption	< 560 W
Surge current	30 A peak (25 °C) for ≤ 5 line cycles, after product has been turned off for at least 30 s.

## Mechanical (Physical) Characteristics

**Table 24: Mechanical characteristics**

Characteristics	Description
Net weight ( <i>Typical</i> )	
Without package	19 kg (41.9 lb)
With package	28 kg (61.7 lb)
Dimensions, overall	
Height	245 mm (9.6 in)
Width	465 mm (18.3 in)
Length	500 mm (19.7 in)
Dimensions, with packaging	
Height	635 mm (25 in)
Width	665 mm (26.2 in)
Length	500 mm (19.7 in)
Cooling method	Forced-air circulation with no air filter
Clearance	
Top	20 mm (0.8 in)
Bottom	20 mm (0.8 in)
Left side	150 mm (6 in)
Right side	150 mm (6 in)
Rear	75 mm (3 in)

## Environmental Characteristics

Table 25: Environmental characteristics

Characteristics	Description
Temperature	
Operating	+10 °C to +40 °C (+50 °F to 104 °F) with 15 °C/hour (59 °F/hour) maximum gradient, noncondensing derated 1.0 °C (34 °F) per 300 m (984 ft) above 1500 m (4921 ft) altitude
Nonoperating	-20 °C to +60 °C (-4 °F to 140 °F) with 30 °C/hour (86 °F/hour) maximum gradient, with no media installed in disc drives
Relative humidity	
Operating	5% to 90% relative humidity at up to +30 °C (+86 °F) 5% to 45% relative humidity above +30 °C (+86 °F) up to +40 °C (104 °F) noncondensing, and as limited by a maximum wet-bulb temperature +29 °C (84.2 °F) (derates relative humidity to 45% relative humidity at +40 °C (104 °F))
Nonoperating	5% to 90% relative humidity at up to 30 °C 5% to 45% relative humidity above +30 °C (+86 °F) up to +40 °C (104 °F) noncondensing, and as limited by a maximum wet-bulb temperature +29 °C (84.2 °F) (derates relative humidity to 11% relative humidity at +40 °C (104 °F))
Altitude	
Operating	Up to 3,000 m (approximately 10,000 feet) Maximum operating temperature decreases 1 °C (34 °F) each 300 m (984 ft) above 1.5 km (4921 ft)
Nonoperating	Up to 12,000 m (approximately 40,000 feet)

---

# Performance Verification Procedures

Two types of performance verification procedures can be performed on the instrument: *Brief Procedures* and *Performance Tests*. You may not need to perform all of these procedures, depending on what you want to accomplish.

- To rapidly confirm that the instrument functions and was adjusted properly, perform *Diagnostics* and *Calibration*.

**Advantages:** These procedures are quick to do and require no external equipment or signal sources. These procedures perform extensive functional and accuracy testing to provide high confidence that the instrument will perform properly.

- To further check functionality, first perform *Diagnostics* and *Calibration*, and then perform *Functional Test*.

**Advantages:** The procedure requires minimal additional time to perform, and requires minimal equipment. The procedure can be used when the instrument is first received.

- If more extensive confirmation of performance is desired, complete the self tests and functional test, and then do the *Performance Tests*.

**Advantages:** These procedures add direct checking of warranted specifications. These procedures require specific test equipment. (See page 23, *Required Equipment*.)

If you are not familiar with operating this instrument, refer to the online help or the user information supplied with the instrument.

# Brief Procedures

There are three procedures in this section that provide a quick way to confirm basic functionality and proper adjustment:

- *Diagnostics*
- *Calibration*
- *Functional Test*

## Diagnostics

The following steps run the internal routines that confirm basic functionality and proper adjustment.

Equipment	Prerequisites
None	None

1. Disconnect all the cables from the output channels.
2. Select **System > Diagnostics**.

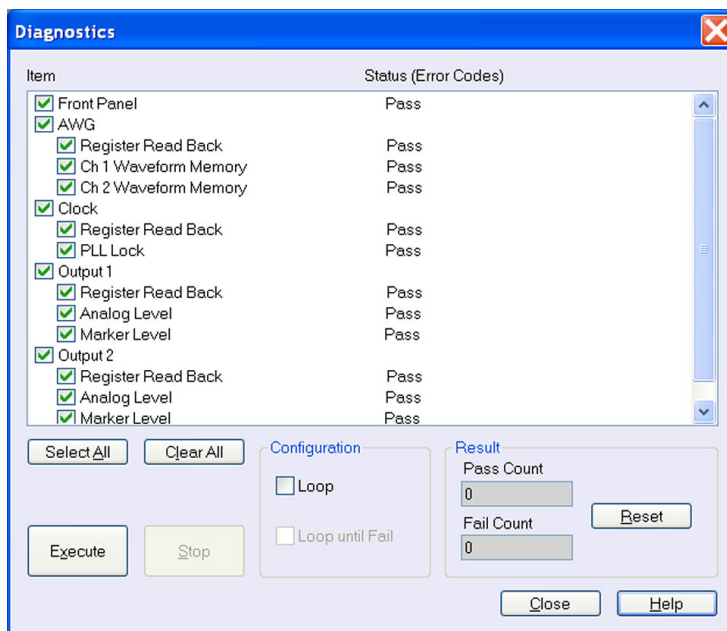

Figure 1: Diagnostics dialog box

3. In the Diagnostics dialog box, confirm that all the check boxes are selected. If they are not all selected, click the **Select All** button.



- Click the **Execute** button to execute the diagnostics.

The internal diagnostics perform an exhaustive verification of proper instrument function. This verification may take several minutes. When the verification is completed, the resulting status will appear in the dialog box.

- Verify that **Pass** appears as Status in the dialog box when the diagnostics complete.
- Click the **Close** button.

## Calibration

Equipment	Prerequisites
None	Power on the instrument and allow a 20 minute warm-up before doing this procedure.

- Select **System > Calibration**.

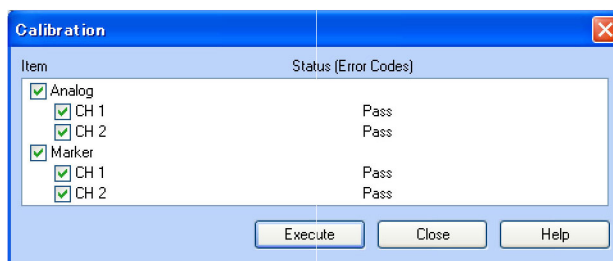

**Figure 2: Calibration dialog box**

- Click the **Execute** button to start the routine.
- Verify that **Pass** appears in the status column for all items when the calibration completes.
- Click the **Close** button.

## Functional Test

The purpose of the procedure is to confirm that the instrument functions properly. The required equipment is SMA cables, SMA terminations, SMA female to BNC male adapters, and an oscilloscope.

### Checking the Analog and Marker Outputs

Required equipment	Prerequisites
Oscilloscope (DPO7054 or equivalent)	None
Three 50 $\Omega$ SMA cables	
Three 50 $\Omega$ SMA terminations	
Three SMA female to BNC male adapters	

1. Press the **All Outputs On/Off** button on the instrument to turn off all the outputs.
2. Use a 50  $\Omega$  SMA cable and a SMA female to BNC male adapter to connect the Channel 1 Analog connector on the instrument to the CH1 connector on the oscilloscope.
3. Use a 50  $\Omega$  SMA cable and a SMA female to BNC male adapter to connect the Channel 1 Mkr 1 connector on the instrument to the CH2 connector on the oscilloscope.
4. Use the 50  $\Omega$  SMA cable and the SMA female to BNC male adapter to connect the Channel 1 Mkr 2 connector on the instrument to the CH3 connector on the oscilloscope.
5. Use a 50  $\Omega$  SMA termination to terminate the Channel 1  $\overline{\text{Analog}}$  connector on the instrument.
6. Use a 50  $\Omega$  SMA termination to terminate the Channel 1  $\overline{\text{Mkr 1}}$  connector on the instrument.
7. Use the 50  $\Omega$  SMA termination to terminate the Channel 1  $\overline{\text{Mkr 2}}$  connector on the instrument.

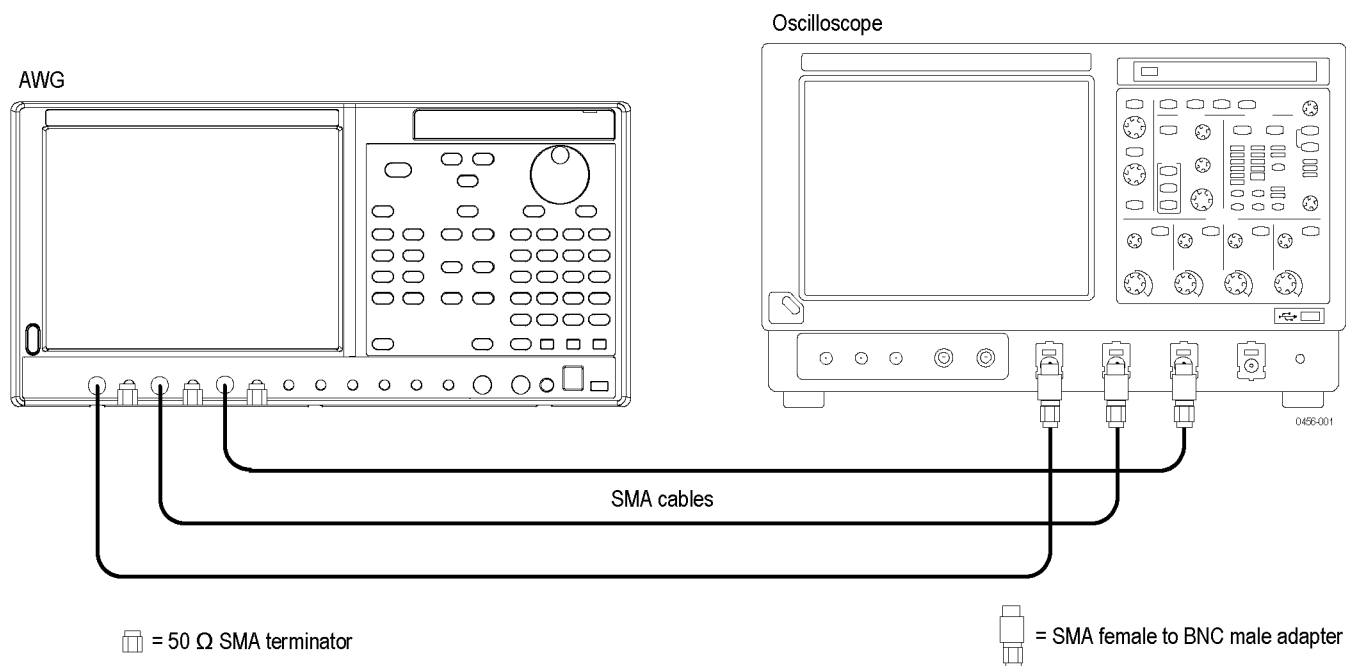

**Figure 3: Equipment connections for checking the analog and marker outputs**

8. Set the oscilloscope as follows:
  - a. Vertical scale: 1 V/div (CH1, CH2, and CH3)
  - b. Horizontal scale: 20 ns/div (for the AWG7122C), 40 ns/div (for the AWG7082C)
  - c. Input coupling: DC
  - d. Input impedance: 50  $\Omega$
  - e. CH 1 position: +2 div (if necessary)
  - f. CH 2 position: -1 div (if necessary)
  - g. CH 3 position: -3 div (if necessary)
  - h. Trigger source: CH1
  - i. Trigger level: 0 mV
  - j. Trigger slope: Positive
  - k. Trigger mode: Auto
9. Press the **Factory Default** button on the instrument.
10. Press the **Ch1 Select** button on the instrument.

11. On the instrument, load the **sine\_mk1\_mk2** waveform as an output waveform. Follow the steps below:

- a. Select **File > Open File**.
- b. In the dialog box, navigate to the **C:\Program Files\Tektronix\AWG\System\PV** directory, and then select the **pv\_awg7000b.awg** file.

---

**NOTE.** If your instrument is an AWG7082C, a warning message is displayed when you open the **pv\_awg7000b.awg** file. Ignore the message and press the **OK** button.

---

- c. In the **Waveform List** window, select (drag and drop) the **sine\_mk1\_mk2** waveform on the **User Defined** tab.

12. Press the **Ch 1 On** button on the instrument to enable the channel 1 output.

13. Press the **Run** button on the instrument to output the waveform.

14. Check that the Channel 1 Analog, Mkr 1, and Mkr 2 waveforms are properly displayed on the oscilloscope screen. (See Figure 4.)

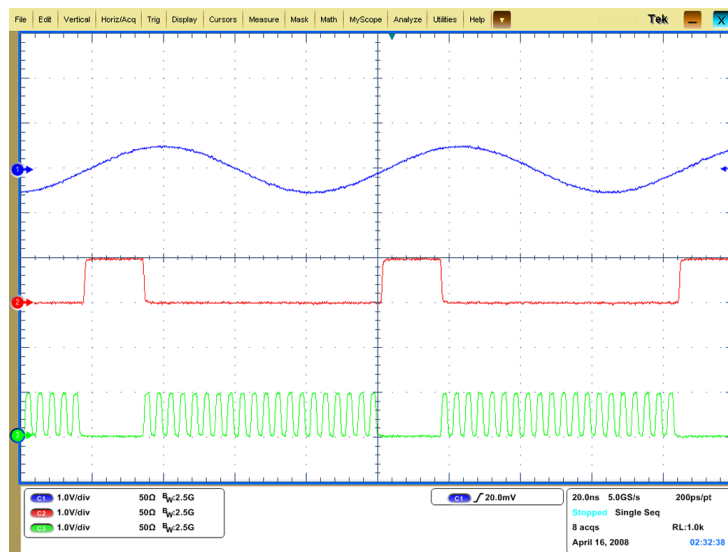

**Figure 4: Output waveform from the Analog, Mkr 1, and Mkr 2 connectors**

15. Press the **Ch 1 On** button again to disable the channel 1 output.

16. Repeat the test for the Channel 2 Analog, Mkr 1, and Mkr 2 outputs.

## Performance Tests

This section contains performance verification procedures for the specifications marked with the ✓ symbol.

### Prerequisites

The tests in this section comprise an extensive, valid confirmation of performance and functionality when the following requirements are met:

- The cabinet must be installed on the instrument.
- You must have performed and passed the procedure *Diagnostics and Calibration*, and the procedure *Functional Tests*.
- The instrument must have been last adjusted at an ambient temperature between +20 °C and +30 °C, must have been operating for a warm-up period of at least 20 minutes, and must be operating at an ambient temperatures between +10 °C and +40 °C.

### Required Equipment

The following table lists the test equipment required to perform all of the performance verification procedure. The table identifies examples of recommended equipment and lists the required precision where applicable. If you substitute other test equipment for the listed examples, the equipment must meet or exceed the listed tolerances.

**Table 26: Required equipment**

Item	Qty.	Minimum requirements	Recommended equipment
Oscilloscope	1 ea.	Bandwidth: 500 MHz or higher 4 channels	Tektronix DPO7054
Frequency counter	1 ea.	Frequency accuracy: within $\pm 0.01$ ppm	Agilent Technologies 53181A
Sampling oscilloscope	1 ea.	Bandwidth: 20 GHz or higher 2 channels	Tektronix DSA8200 with 80E03
Spectrum analyzer	1 ea.	Bandwidth: DC to 8 GHz	Tektronix RSA3308B
Digital multimeter	1 ea.	DC accuracy: within $\pm 0.01\%$	Keithley 2000 DMM or Agilent Technologies 34410A
50 $\Omega$ BNC cable	1 ea.	DC to 2 GHz	Tektronix part number 012-0057-01
50 $\Omega$ SMA cable	3 ea.	DC to 20 GHz	Tensolite 1-3636-465-5236
50 $\Omega$ SMA termination	3 ea.	DC to 18 GHz	Tektronix part number 015-1022-01 (supplied with the AWG)
50 $\Omega$ BNC termination	1 ea.	DC to 1 GHz, feedthrough	Tektronix part number 011-0049-02

**Table 26: Required equipment (cont.)**

Item	Qty.	Minimum requirements	Recommended equipment
50 $\Omega$ SMA attenuator	2 ea.	5 X, 14 dB, DC to 18 GHz	Tektronix part number 015-1002-01
SMA-BNC adapter	3 ea.	SMA female to BNC male connector	Tektronix part number 015-0572-00
SMA-BNC adapter	1 ea.	SMA male to BNC female connector	Tektronix part number 015-0554-00
SMA-N adapter	1 ea.	SMA female to N male connector	Tensolite 5004CCSF
BNC-dual banana adapter	1 ea.	BNC to dual banana plugs	Tektronix part number 103-0090-00
DC output lead set	1 ea.	8-pin twisted pair, 24 inch	Tektronix part number 012-1697-00 (supplied with the AWG)

**Test Waveforms**

The following table lists the test waveforms that are used for the performance verification procedures and functional test. These are included in the pv\_awg7000b.awg file on the C: drive.

**Table 27: Test waveforms**

No.	Waveform name	Purpose
1	dc_minus	For checking the analog amplitude accuracy
2	dc_plus	For checking the analog amplitude accuracy
3	dc_zero	For checking the analog offset accuracy
4	marker_hi	For checking the marker high level accuracy
5	marker_low	For checking the marker low level accuracy
6	sine32	For checking analog harmonic distortion, analog non-harmonic spurious signal, and analog phase noise
7	sine_mk1_mk2	For the functional test
8	square1	For checking the marker output delay accuracy test

**NOTE.** *If your instrument is the AWG7082C, a warning message is displayed when you open the pv\_awg7000b.awg file. Ignore the message and press the OK button.*

## Test Record

Photocopy this page and the next eight pages, and use them to record the performance test results for your instrument.

### AWG7000C Series Performance Test Record

Instrument Model:

Instrument Serial Number:

Certificate Number:

Temperature:

RH %:

Date of Calibration:

Technician:

<b>Performance Test</b>		<b>Minimum</b>	<b>Incoming</b>	<b>Outgoing</b>	<b>Maximum</b>
<i>10 MHz Reference Frequency Accuracy</i>		9.99998 MHz			10.00002 MHz
<i>Analog Offset Accuracy</i>					
AWG7000C standard					
Ch 1	Offset:				
	+0.5 V	480 mV			520 mV
	0.0 V	-10 mV			+10 mV
	-0.5 V	-520 mV			-480 mV
/Ch 1	Offset:				
	+0.5 V	480 mV			520 mV
	0.0 V	-10 mV			+10 mV
	-0.5 V	-520 mV			-480 mV
Ch 2	Offset:				
	+0.5 V	480 mV			520 mV
	0.0 V	-10 mV			+10 mV
	-0.5 V	-520 mV			-480 mV
/Ch 2	Offset:				
	+0.5 V	480 mV			520 mV
	0.0 V	-10 mV			+10 mV
	-0.5 V	-520 mV			-480 mV

## Performance Tests

Performance Test		Minimum	Incoming	Outgoing	Maximum
<i>AWG7000C Option 06 and 02</i>					
Ch 1	Offset				
	N/A (0 V)	-10 mV			10 mV
/Ch 1	Offset				
	N/A (0 V)	-10 mV			10 mV
Ch 2	Offset				
	N/A (0 V)	-10 mV			10 mV
/Ch 2	Offset				
	N/A (0 V)	-10 mV			10 mV
Interleave (Option 06 only)	Offset		Output mode		
	N/A (0 V)	-10 mV	Interleave: On		10 mV
<i>Analog Amplitude Accuracy</i>					
<i>AWG7000C standard</i>					
Ch 1	Amplitude		Output mode		
	50 mV <sub>p-p</sub>	Direct D/A out: Off	46.5 mV		53.5 mV
	200 mV <sub>p-p</sub>	Direct D/A out: Off	192 mV		208 mV
	500 mV <sub>p-p</sub>	Direct D/A out: Off	483 mV		517 mV
	1.0 V <sub>p-p</sub>	Direct D/A/out: Off	0.968 V		1.032 V
	2.0 V <sub>p-p</sub>	Direct D/A/out: Off	1.938 V		2.062 V
	50 mV <sub>p-p</sub>	Direct D/A out: On	46.5 mV		53.5 mV
	200 mV <sub>p-p</sub>	Direct D/A out: On	192 mV		208 mV
	1.0 V <sub>p-p</sub>	Direct D/A out: On	0.968 V		1.032 V
/Ch 1	Amplitude		Output mode		
	50 mV <sub>p-p</sub>	Direct D/A out: Off	46.5 mV		53.5 mV
	200 mV <sub>p-p</sub>	Direct D/A out: Off	192 mV		208 mV
	500 mV <sub>p-p</sub>	Direct D/A out: Off	483 mV		517 mV
	1.0 V <sub>p-p</sub>	Direct D/A/out: Off	0.968 V		1.032 V
	2.0 V <sub>p-p</sub>	Direct D/A/out: Off	1.938 V		2.062 V
	50 mV <sub>p-p</sub>	Direct D/A out: On	46.5 mV		53.5 mV
	200 mV <sub>p-p</sub>	Direct D/A out: On	192 mV		208 mV
	1.0 V <sub>p-p</sub>	Direct D/A out: On	0.968 V		1.032 V



Performance Test		Minimum	Incoming	Outgoing	Maximum
Ch 2	Amplitude	Output mode			
	50 mV <sub>p-p</sub>	Direct D/A out: Off	46.5 mV		53.5 mV
	200 mV <sub>p-p</sub>	Direct D/A out: Off	192 mV		208 mV
	500 mV <sub>p-p</sub>	Direct D/A out: Off	483 mV		517 mV
	1.0 V <sub>p-p</sub>	Direct D/A/out: Off	0.968 V		1.032 V
	2.0 V <sub>p-p</sub>	Direct D/A/out: Off	1.938 V		2.062 V
	50 mV <sub>p-p</sub>	Direct D/A out: On	46.5 mV		53.5 mV
	200 mV <sub>p-p</sub>	Direct D/A out: On	192 mV		208 mV
	1.0 V <sub>p-p</sub>	Direct D/A out: On	0.968 V		1.032 V
/Ch 2	Amplitude	Output mode			
	50 mV <sub>p-p</sub>	Direct D/A out: Off	46.5 mV		53.5 mV
	200 mV <sub>p-p</sub>	Direct D/A out: Off	192 mV		208 mV
	500 mV <sub>p-p</sub>	Direct D/A out: Off	483 mV		517 mV
	1.0 V <sub>p-p</sub>	Direct D/A/out: Off	0.968 V		1.032 V
	2.0 V <sub>p-p</sub>	Direct D/A/out: Off	1.938 V		2.062 V
	50 mV <sub>p-p</sub>	Direct D/A out: On	46.5 mV		53.5 mV
	200 mV <sub>p-p</sub>	Direct D/A out: On	192 mV		208 mV
	1.0 V <sub>p-p</sub>	Direct D/A out: On	0.968 V		1.032 V
AWG7000C Option 06 and 02					
Ch 1	Amplitude				
	500 mV <sub>p-p</sub>		488 mV		512 mV
	1.0 V <sub>p-p</sub>		0.978 mV		1.022 mV
/Ch 1	Amplitude				
	500 mV <sub>p-p</sub>		488 mV		512 mV
	1.0 V <sub>p-p</sub>		0.978 mV		1.022 mV
Ch 2	Amplitude				
	500 mV <sub>p-p</sub>		488 mV		512 mV
	1.0 V <sub>p-p</sub>		0.978 mV		1.022 mV
/Ch 2	Amplitude				
	500 mV <sub>p-p</sub>		488 mV		512 mV
	1.0 V <sub>p-p</sub>		0.978 mV		1.022 mV

## Performance Tests

Performance Test		Minimum	Incoming	Outgoing	Maximum
<i>Analog Harmonic Distortion</i>					
AWG7122C standard					
Ch 1	Amplitude	Output mode			
	1.0 V	Direct D/A out: Off	none		-35 dBc
	1.0 V	Direct D/A out: On	none		-42 dBc
Ch 2	Amplitude	Output mode			
	1.0 V	Direct D/A out: Off	none		-35 dBc
	1.0 V	Direct D/A out: On	none		-42 dBc
AWG7082C standard					
Ch 1	Amplitude	Output mode			
	1.0 V	Direct D/A out: Off	none		-40 dBc
	1.0 V	Direct D/A out: On	none		-45 dBc
Ch 2	Amplitude	Output mode			
	1.0 V	Direct D/A out: Off	none		-40 dBc
	1.0 V	Direct D/A out: On	none		-45 dBc
AWG7000 Option 06 and 02					
Ch 1	Amplitude				
	1.0 V		none		-42 dBc
Ch 2	Amplitude				
	1.0 V		none		-42 dBc

Performance Test		Minimum	Incoming	Outgoing	Maximum
<i>Analog Non-Harmonic Spurious</i>					
AWG7000C standard					
Ch 1	Amplitude				
	1.0 V	Direct D/A out: Off	none		-50 dBc
	1.0 V	Direct D/A out: On	none		-50 dBc
Ch 2	Amplitude				
	1.0 V	Direct D/A out: Off	none		-50 dBc
	1.0 V	Direct D/A out: On	none		-50 dBc
AWG7000C Option 06 and 02					
Ch 1	Amplitude				
	1.0 V		none		-50 dBc
Ch 2	Amplitude				
	1.0 V		none		-50 dBc
<i>Analog Phase Noise (at 10 kHz offset)</i>					
AWG7000C standard					
Ch 1	Amplitude				
	1.0 V		none		-90 dBc/Hz
	1.0 V		none		-90 dBc/Hz
Ch 2	Amplitude				
	1.0 V		none		-90 dBc/Hz
	1.0 V		none		-90 dBc/Hz
AWG7000C Option 06 and 02					
Ch 1	Amplitude				
	1.0 V		none		-90 dBc/Hz
Ch 2	Amplitude				
	1.0 V		none		-90 dBc/Hz
Interleave (Option 06 only)	Amplitude				
	0.5 V	Interleave: On Zeroing: On	none		-85 dBc/Hz
	1.0 V	Interleave: On Zeroing: Off	none		-85 dBc/Hz

Performance Test		Minimum	Incoming	Outgoing	Maximum
<i>Marker High and Low Level Accuracy</i>					
AWG7000C					
Ch 1	Mkr 1	High level setting			
		+1.4 V	1.185 V		1.615 V
		0.0 V	-75 mV		+75 mV
		-0.9 V	-1.065 V		-0.735 V
		Low level setting			
		+0.9 V	0.735 V		1.065 V
		0.0 V	-75 mV		+75 mV
		-1.4 V	-1.615 V		-1.185 V
		/Mkr 1	High level setting		
	+1.4 V		1.185 V		1.615 V
	0.0 V		-75 mV		+75 mV
	-0.9 V		-1.065 V		-0.735 V
	Low level setting				
	+0.9 V		0.735 V		1.065 V
	0.0 V		-75 mV		+75 mV
-1.4 V	-1.615 V			-1.185 V	
Mkr 2	Mkr 2		High level setting		
		+1.4 V	1.185 V		1.615 V
		0.0 V	-75 mV		+75 mV
		-0.9 V	-1.065 V		-0.735 V
		Low level setting			
		+0.9 V	0.735 V		1.065 V
		0.0 V	-75 mV		+75 mV
		-1.4 V	-1.615 V		-1.185 V
		/Mkr 2	High level setting		
	+1.4 V		1.185 V		1.615 V
	0.0 V		-75 mV		+75 mV
	-0.9 V		-1.065 V		-0.735 V
	Low level setting				
	+0.9 V		0.735 V		1.065 V
	0.0 V		-75 mV		+75 mV
-1.4 V	-1.615 V			-1.185 V	

Performance Test			Minimum	Incoming	Outgoing	Maximum	
Ch 2	Mkr 1	High level setting					
		+1.4 V	1.185 V			1.615 V	
		0.0 V	-75 mV			+75 mV	
		-0.9 V	-1.065 V			-0.735 V	
		Low level setting					
		+0.9 V	0.735 V			1.065 V	
		0.0 V	-75 mV			+75 mV	
		-1.4 V	-1.615 V			-1.185 V	
		/Mkr 1	High level setting				
	+1.4 V	1.185 V			1.615 V		
	0.0 V	-75 mV			+75 mV		
	-0.9 V	-1.065 V			-0.735 V		
	Low level setting						
	+0.9 V	0.735 V			1.065 V		
	0.0 V	-75 mV			+75 mV		
	-1.4 V	-1.615 V			-1.185 V		
	Mkr 2	Mkr 2	High level setting				
			+1.4 V	1.185 V			1.615 V
0.0 V			-75 mV			+75 mV	
-0.9 V			-1.065 V			-0.735 V	
Low level setting							
+0.9 V			0.735 V			1.065 V	
0.0 V			-75 mV			+75 mV	
-1.4 V			-1.615 V			-1.185 V	
/Mkr 2			High level setting				
+1.4 V		1.185 V			1.615 V		
0.0 V		-75 mV			+75 mV		
-0.9 V		-1.065 V			-0.735 V		
Low level setting							
+0.9 V		0.735 V			1.065 V		
0.0 V		-75 mV			+75 mV		
-1.4 V		-1.615 V			-1.185 V		

## Performance Tests

---

Performance Test		Minimum	Incoming	Outgoing	Maximum
<i>Marker Output Delay Accuracy</i>					
AWG7000C					
Ch 1	Mkr 1	92.5 ps			207.5 ps
	Mkr 2	92.5 ps			207.5 ps
Ch 2	Mkr 1	92.5 ps			207.5 ps
	Mkr 2	92.5 ps			207.5 ps
<i>DC Output Accuracy</i>					
AWG7000C					
	DC output:				
	+5 V	4.73 V			5.27 V
	+3 V	2.79 V			3.21 V
	0.0 V	-120 mV			+120 mV
	-3 V	-3.21 V			-2.79 V

## 10 MHz Reference Frequency Accuracy

Required equipment	Prerequisites
Frequency counter	(See page 23, <i>Prerequisites</i> .)
50 $\Omega$ BNC cable	

1. Use the 50  $\Omega$  BNC cable to connect the 10 MHz Reference Output connector on the instrument to the frequency counter CH1 input.

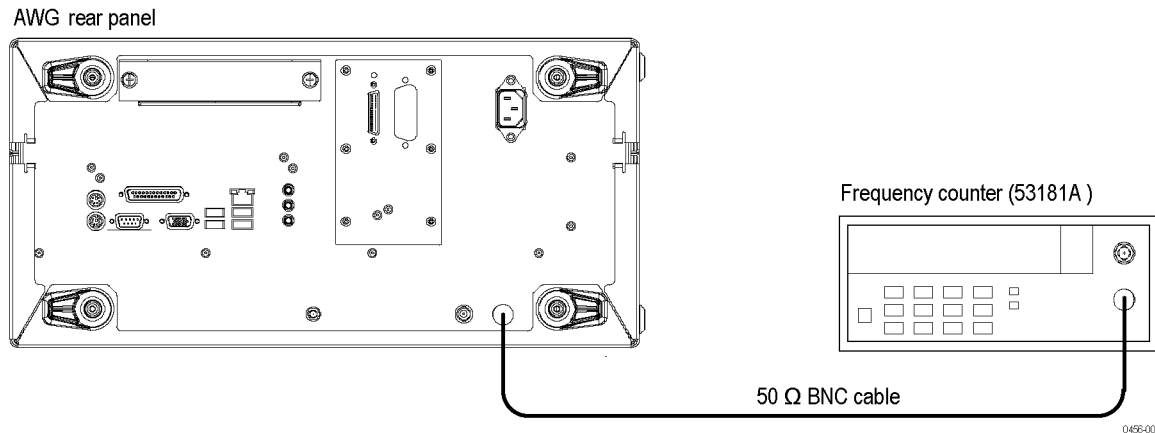

Figure 5: Equipment connection for verifying the 10 MHz reference frequency accuracy

2. Set the frequency counter as follows:
  - a. MEASURE: Frequency1, Gate Time: 0.10 s
  - b. CHANNEL1: Coupling: AC, Impedance: 50  $\Omega$
3. Press the **Factory Default** button on the instrument.
4. Verify that the frequency counter reading falls within the range of 9.99998 MHz to 10.00002 MHz ( $\pm 2$  ppm).
5. Disconnect the test setup.

## Analog Offset Accuracy

Required equipment	Prerequisites
Digital multimeter	(See page 23, <i>Prerequisites</i> .)
50 $\Omega$ BNC cable	
SMA male-BNC female adapter	
50 $\Omega$ BNC termination	
BNC-dual banana adapter	
50 $\Omega$ SMA termination	

### Measuring the Termination Resistance

Before verifying the analog offset accuracy, you need to measure the resistance of the 50  $\Omega$  **BNC termination**.

1. Connect the BNC-dual banana adapter and 50  $\Omega$  BNC termination to the HI and LO inputs on the digital multimeter.

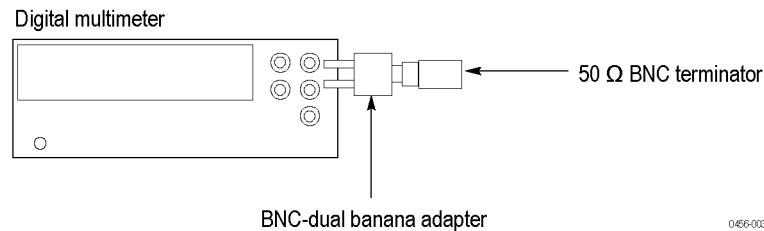

**Figure 6: Equipment connection for measuring the termination resistance**

2. Set the digital multimeter to the **W 2 wires** mode.
3. Measure the resistance and note the value as **Term\_R**.
4. Set the digital multimeter to the **VDC** mode.
5. Disconnect the test setup.

**NOTE.** Lead resistance is not included in the measurement results when using four wire ohms. The accuracy is higher especially for small resistances. Use a four wire method if necessary.

### Verifying the Analog Offset Accuracy

1. Press the **All Outputs On/Off** button on the instrument to turn off all the outputs.
2. Use the 50  $\Omega$  BNC cable, SMA-BNC adapter, 50  $\Omega$  BNC termination, and BNC-Banana adapter to connect the Channel 1 Analog connector on the instrument to the HI and LO inputs on the digital multimeter.
3. Use the 50  $\Omega$  SMA termination to terminate the Channel 1 Analog connector on the instrument.



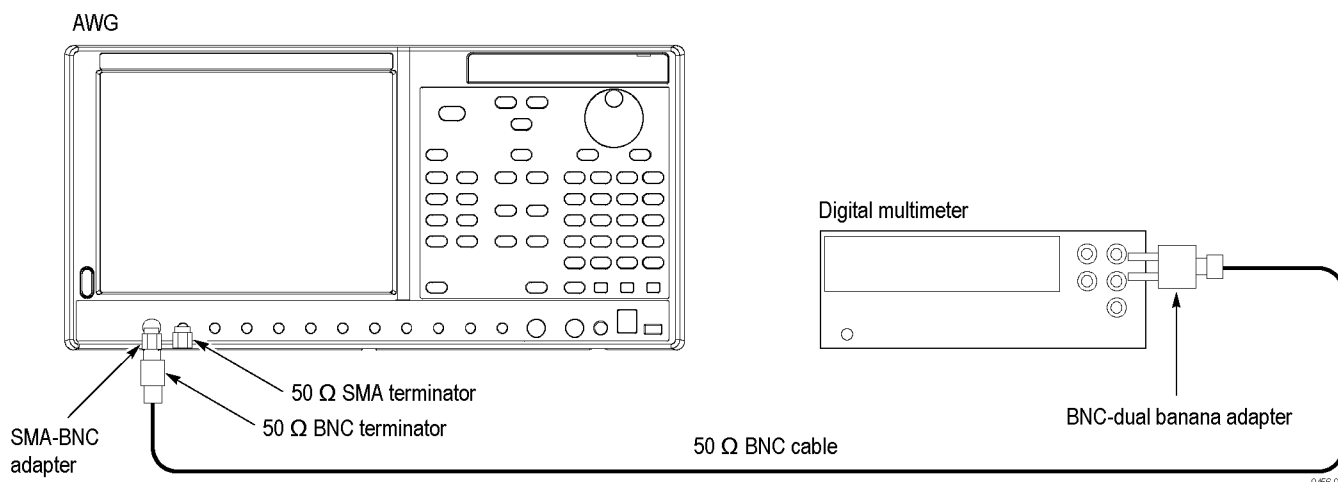

Figure 7: Equipment connection for verifying the analog offset accuracy

4. Press the **Factory Default** button on the instrument.
5. Press the **Ch1 Select** button on the instrument.
6. On the instrument, load the **dc\_zero** waveform as an output waveform.
  - a. Select **File > Open File**.
  - b. In the dialog box, navigate to the **C:\Program Files\Tektronix\AWG\System\PV** directory, and then select the **pv\_awg7000b.awg** file. The **Waveform List** window appears.
  - c. In the window, select (drag and drop) the **dc\_zero** waveform on the **User Defined** tab.
7. Press the **Ch 1 On** button on the instrument to enable the channel 1 output.
8. Press the **Run** button on the instrument to output the waveform.
9. Set the offset of the instrument to the level shown in the first row (or the corresponding row for your instrument) of the following table:

Table 28: Analog offset accuracy

Model	Offset settings	Accuracy limits
AWG7000C standard	+0.5 V	480 mV to 520 mV
	0.0 V	-10 mV to +10 mV
	-0.5 V	-520 mV to -480 mV
AWG7000C Options 06 and 02	N/A (0 V)	-10 mV to +10 mV

10. Measure the output voltage on the digital multimeter and note the value as **Measured\_voltage**.

11. Use the following formula to compensate the voltage for the 50  $\Omega$  BNC termination:

$$\text{Voltage} = [(\text{Term\_R} + 50) / (2 \text{ Term\_R})] \text{ Measured\_voltage}$$

Where Term\_R is the resistance of the 50  $\Omega$  BNC termination measured in step 3 in the *Measuring the Termination Resistance*. (See page 34.)

12. Verify that the calculated value falls within the limits given in the table. (See Table 28 on page 35.)
13. Repeat steps 9 through 12 for each offset setting in the table. (See Table 28 on page 35.)
14. Move the SMA-BNC adapter from the Channel 1 Analog connector to the Channel 1 Analog connector and move the 50  $\Omega$  SMA termination from the Channel 1 Analog connector to the Channel 1 Analog connector.
15. Repeat steps 9 through 13.
16. Repeat steps 6 through 15 for the Channel 2 output.
17. Press the **All Outputs On/Off** button on the instrument to turn off all the outputs.
18. Disconnect the test setup.

## Analog Amplitude Accuracy

Required equipment	Prerequisites
Digital multimeter	(See page 23, <i>Prerequisites</i> .)
50 $\Omega$ BNC cable	
SMA male-BNC female adapter	
50 $\Omega$ BNC termination	
BNC-dual banana adapter	
50 $\Omega$ SMA termination	

1. Perform *Measuring the Termination Resistance*. (See page 34.)
2. Press the **All Outputs On/Off** button on the instrument to turn off all the outputs.
3. Use the 50  $\Omega$  BNC cable, SMA-BNC adapter, 50  $\Omega$  BNC termination, and BNC-Banana adapter to connect the Channel 1 Analog connector on the instrument to the HI and LO inputs on the digital multimeter. (See Figure 7 on page 35.)
4. Use the 50  $\Omega$  SMA termination to terminate the Channel 1 Analog connector on the instrument. (See Figure 7 on page 35.)
5. Press the **Factory Default** button on the instrument.

6. Press the **Ch 1 Select** button on the instrument.
7. On the instrument, load the **dc\_plus** waveform as an output waveform.
  - a. Select **File > Open File**.
  - b. In the dialog box, navigate to the **C:\Program Files\Tektronix\AWG\System\PV** directory, and then select the **pv\_awg7000b.awg** file. The **Waveform List** window appears.
  - c. In the window, select (drag and drop) the **dc\_plus** waveform on the **User Defined** tab.
8. Press the **Ch 1 On** button on the instrument to enable the channel 1 output.
9. Press the **Run** button on the instrument to output the waveform.
10. Set the amplitude and output mode of the instrument as shown in the first row (or the corresponding row for your instrument) of the following table:

Table 29: Analog amplitude accuracy

Model	Amplitude settings	Output mode settings	Accuracy limits
AWG7000C standard	50 mV <sub>p-p</sub>	————	46.5 mV to 53.5 mV
	200 mV <sub>p-p</sub>	————	192 mV to 208 mV
	500 mV <sub>p-p</sub>	————	483 mV to 517 mV
	1.0 V <sub>p-p</sub>	————	0.968 V to 1.032 V
	2.0 V <sub>p-p</sub>	————	1.938 V to 2.062 V
	50 mV <sub>p-p</sub>	Direct D/A out: On	46.5 mV to 53.5 mV
	200 mV <sub>p-p</sub>	Direct D/A out: On	192 mV to 208 mV
AWG7000C Option 02	500 mV <sub>p-p</sub>	————	488 mV to 512 mV
	1.0 V <sub>p-p</sub>	————	0.978 V to 1.022 V
AWG7000C Option 06	500 mV <sub>p-p</sub>	Interleave: Off (Option 06)	488 mV to 512 mV
	1.0 V <sub>p-p</sub>	Interleave: Off (Option 06)	0.978 V to 1.022 V

11. Measure the output voltage on the digital multimeter and note the value as **Measured\_voltage\_1**.
12. Use the following formula to compensate the voltage for the 50 Ω BNC termination:

$$V_{\text{high}} = [(Term\_R + 50) / (2 Term\_R)] \text{ Measured\_voltage\_1}$$

Where Term\_R is the resistance of the 50 Ω BNC termination measured in step 3 in the *Measuring the Termination Resistance*. (See page 34.)

13. In the **Waveform List** window, select the **dc\_minus** waveform on the **User Defined** tab.
14. Measure the output voltage on the digital multimeter and note the value as **Measured\_voltage\_2**.
15. Use the following formula to compensate the voltage for the 50  $\Omega$  BNC termination:  
$$V_{low} = [(Term\_R + 50) / (2 Term\_R)] Measured\_voltage\_2$$

Where Term\_R is the resistance of the 50  $\Omega$  BNC termination measured in step 3 in the *Measuring the Termination Resistance*. (See page 34.)
16. Verify that the voltage difference  $|(V_{high}-V_{low})|$  falls within the limits given in the table. (See Table 29 on page 37.)
17. Repeat steps 10 through 16 for each amplitude setting in the table. (See Table 29 on page 37.)
18. Move the SMA-BNC adapter from the Channel 1 Analog connector to the Channel 1 Analog connector and move the 50  $\Omega$  SMA termination from the Channel 1 Analog connector to the Channel 1 Analog connector.
19. Repeat steps 10 through 17.
20. Repeat steps 6 through 18 for the Channel 2 output.
21. Press the **All Outputs On/Off** button on the instrument to turn off all the outputs.
22. Disconnect the test setup.

## Analog Harmonic Distortion

Required equipment	Prerequisites
Spectrum analyzer	(See page 23, <i>Prerequisites</i> .)
50 $\Omega$ SMA cable	
SMA-N adapter	
50 $\Omega$ SMA termination	

1. Press the **All Outputs On/Off** button on the instrument to turn off all the outputs.
2. Use the 50  $\Omega$  SMA cable and SMA-N adapter to connect the Channel 1 Analog connector on the instrument to the INPUT connector on the spectrum analyzer.
3. Use the 50  $\Omega$  SMA termination to terminate the Channel 1 Analog connector on the instrument.

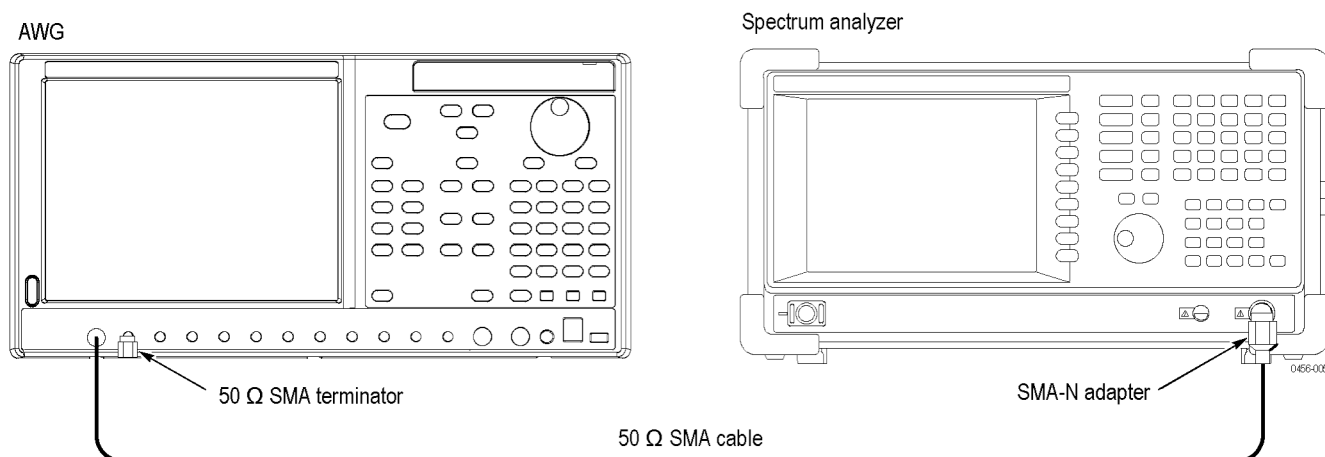

Figure 8: Equipment connections for verifying the analog harmonic distortion

4. Set the spectrum analyzer as follows:
  - a. Center frequency: 1.5 GHz
  - b. Span: 3 GHz
  - c. RBW: 1 MHz
  - d. Amplitude: 10 dBm
5. Press the **Factory Default** button on the instrument.
6. Press the **Ch 1 Select** button on the instrument.

7. On the instrument, load the **sine\_32** waveform as an output waveform.
  - a. Select **File > Open File**.
  - b. In the dialog box, navigate to the **C:\Program Files\Tektronix\AWG\System\PV** directory, and then select the **pv\_awg7000b.awg** file. The **Waveform List** window appears.
  - c. In the window, select (drag and drop) the **sine\_32** waveform on the **User Defined** tab.
8. Press the **Ch 1 On** button on the instrument to enable the channel 1 output.
9. Press the **Run** button on the instrument to output the waveform.
10. Make the settings shown in the first row (or corresponding row for your instrument) of the following table:

Table 30: Analog harmonic distortion

AWG7000C model and settings				Measurement frequency (MHz)				Accuracy limit
Model	Output mode	Amplitude	Sampling rate (output frequency)	2nd	3rd	4th	5th	Nth reference
AWG7122C	Direct out: Off	1.0 V <sub>p-p</sub>	12 GS/s (375 MHz)	750	1125	1500	1875	< -35 dBc
	Direct out: On							< -42 dBc
AWG7122C Option 02	Direct out: On	1.0 V <sub>p-p</sub>	12 GS/s (375 MHz)	750	1125	1500	1875	< -42 dBc
AWG7122C Option 06	Interleave: Off	1.0 V <sub>p-p</sub>	12 GS/s (375 MHz)	750	1125	1500	1875	< -42 dBc
AWG7082C	Direct out: Off	1.0 V <sub>p-p</sub>	8 GS/s (250 MHz)	500	725	1000	1250	< -37 dBc
	Direct out: On							< -43 dBc
AWG7082C Option 06	Interleave: Off	1.0 V <sub>p-p</sub>	8 GS/s (250 MHz)	500	725	1000	1250	< -44 dBc
AWG7082C Option 02	Direct out: On	1.0 V <sub>p-p</sub>	8 GS/s (250 MHz)	500	725	1000	1250	< -44 dBc

11. Use the delta measurement function of the spectrum analyzer to measure harmonic distortion of each measurement frequency.
12. Verify that the harmonic distortion falls within the limits given in the table. (See Table 30.)
13. Repeat steps 10 through 12 for each setting in the table. (See Table 30.)
14. Repeat the test for the Channel 2 output.
15. Press the **All Outputs On/Off** button on the instrument to turn off all the outputs.
16. Disconnect the test setup.

## Analog Non-Harmonic Spurious Signal

Required equipment	Prerequisites
Spectrum analyzer	(See page 23, <i>Prerequisites</i> .)
50 $\Omega$ SMA cable	
SMA-N adapter	
50 $\Omega$ SMA termination	

1. Press the **All Outputs On/Off** button on the instrument to turn off all the outputs.
2. Use the 50  $\Omega$  SMA cable and SMA-N adapter to connect the Channel 1 Analog connector on the instrument to the INPUT connector on the spectrum analyzer.
3. Use the 50  $\Omega$  SMA termination to terminate the Channel 1  $\overline{\text{Analog}}$  connector on the instrument.

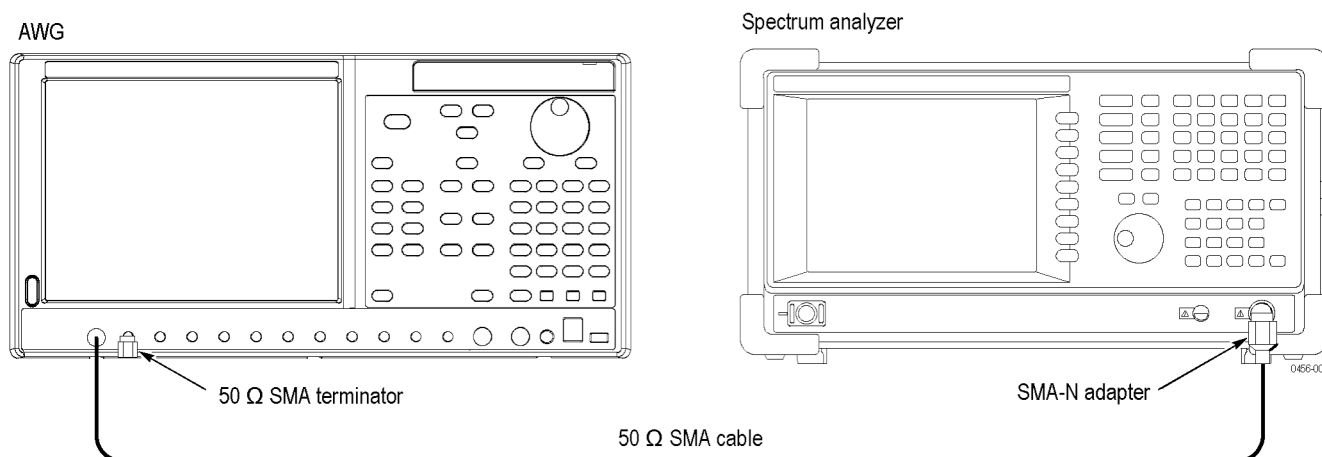

Figure 9: Equipment connections for verifying the non-harmonic spurious signal

4. Press the **Factory Default** button on the instrument.
5. Press the **Ch1 Select** button on the instrument.
6. On the instrument, load the **sine\_32** waveform as an output waveform.
  - a. Select **File > Open File**.
  - b. In the dialog box, navigate to the **C:\Program Files\Tektronix\AWG\System\PV** directory, and then select the **pv\_awg7000b.awg** file. The **Waveform List** window appears.
  - c. In the window, select (drag and drop) the **sine\_32** waveform on the **User Defined** tab.
7. Press the **Ch 1 On** button on the instrument to enable the channel 1 output.
8. Press the **Run** button on the instrument to output the waveform.

9. Make the instrument and spectrum analyzer settings shown in the first row (or the corresponding row for your instrument) of the following table:

Table 31: Analog non-harmonic spurious signal

AWG7000C model and settings				Spectrum analyzer settings			
Model	Output mode	Amplitude	Sampling rate (output frequency)	Center frequency	Span	RBW	Accuracy limit
AWG7122C	Direct out: On/Off	1.0 V <sub>p-p</sub>	12 GS/s (375 MHz)	1.5 GHz	3 GHz	1 MHz	< -50 dBc
				2 GHz	3 GHz	1 MHz	
				5 GHz	3 GHz	1 MHz	
AWG7122C Option 02	Direct out: On	1.0 V <sub>p-p</sub>	12 GS/s (375 MHz)	1.5 GHz	3 GHz	1 MHz	< -50 dBc
				2 GHz	3 GHz	1 MHz	
				5 GHz	3 GHz	1 MHz	
AWG7122C Option 06	Interleave: Off	1.0 V <sub>p-p</sub>	12 GS/s (375 MHz)	1.5 GHz	3 GHz	1 MHz	< -50 dBc
				2 GHz	3 GHz	1 MHz	
				5 GHz	3 GHz	1 MHz	
AWG7082C	Direct out: On/Off	1.0 V <sub>p-p</sub>	8 GS/s (250 MHz)	1.5 GHz	3 GHz	1 MHz	< -50 dBc
AWG7082C Option 02	Direct out: On	1.0 V <sub>p-p</sub>	8 GS/s (250 MHz)	1.5 GHz	3 GHz	1 MHz	< -50 dBc
AWG7082C Option 06	Interleave: Off	1.0 V <sub>p-p</sub>	8 GS/s (250 MHz)	1.5 GHz	3 GHz	1 MHz	< -50 dBc

10. Use the spectrum analyzer to measure non-harmonic spurious signal of the Analog output over a frequency range of DC to 6 GHz (for the AWG7082C, DC to 3 GHz). For example, note the reference level of the fundamental waveform, and then measure each spurious signal.
11. Verify that the non-harmonic spurious signal falls within the limits given in the table. (See Table 31.)
12. Repeat steps 9 through 11 for each setting in the table.
13. Repeat the test for the Channel 2 output.
14. Press the **All Outputs On/Off** button on the instrument to turn off all the outputs.
15. Disconnect the test setup.



## Analog Phase Noise

Required equipment	Prerequisites
Spectrum analyzer	(See page 23, <i>Prerequisites</i> .)
50 $\Omega$ SMA cable	
SMA-N adapter	
50 $\Omega$ SMA termination	

1. Press the **All Outputs On/Off** button on the instrument to turn off all the outputs.
2. Use the 50  $\Omega$  SMA cable and SMA-N adapter to connect the Channel 1 Analog connector on the instrument to the INPUT connector on the spectrum analyzer.
3. Use the 50  $\Omega$  SMA termination to terminate the Channel 1 Analog connector on the instrument.

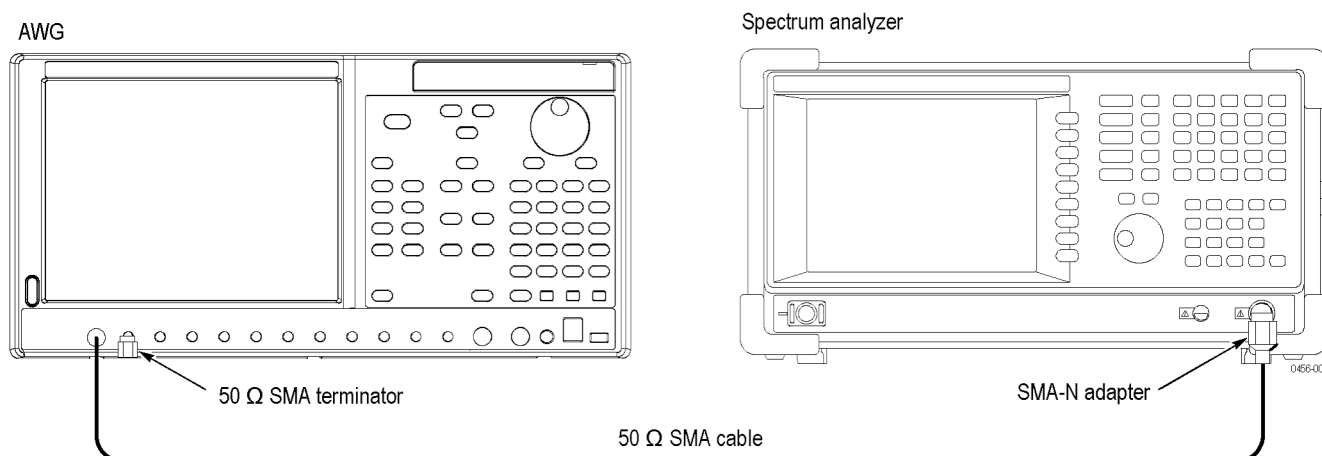

Figure 10: Equipment connections for verifying the analog phase noise

4. Press the **Factory Default** button on the instrument.
5. On the instrument, load the **sine\_32** waveform as an output waveform.
  - a. Select **File > Open File**.
  - b. In the dialog box, navigate to the **C:\Program Files\Tektronix\AWG\System\PV** directory, and then select the **pv\_awg7000b.awg** file. The **Waveform List** window appears.
  - c. In the window, select (drag and drop) the **sine\_32** waveform on the **User Defined** tab.
6. Press the **Ch 1 On** button on the instrument to enable the channel 1 output.
7. Press the **Run** button on the instrument to output the waveform.
8. Make the instrument and spectrum analyzer settings shown in the first row (or the corresponding row for your instrument) of the table. (See Table 32.)

9. Use the spectrum analyzer to measure phase noise of the Analog output.
10. Verify that the analog phase noise at 10 kHz offset falls within the limits given in the table.
11. Repeat steps 8 through 10 for each row in the following table.
12. Repeat the test for the Channel 2 output.
13. *For the AWG7122C Option 06:* Repeat the test for the Interleave output. Set the Timing Sampling Rate to 24 GS/s to turn on the Interleave.
14. *For the AWG7082C Option 06:* Repeat the test for the Interleave output. Set the Timing Sampling Rate to 16 GS/s to turn on the Interleave.

Table 32: Analog phase noise

AWG7000C model and settings			Spectrum analyzer settings				
Model	Output mode	Amplitude	Sampling rate	Center frequency	Span	RBW	Accuracy Limit at 10 kHz offset
AWG7122C	Direct out: On/Off	1.0 V <sub>p-p</sub>	12 GS/s	375 MHz	50 kHz	100 Hz	< -90 dBc/Hz
AWG7122C Option 06	Interleave: Off	1.0 V <sub>p-p</sub>	12 GS/s	375 MHz	50 kHz	100 Hz	< -90 dBc/Hz
	Interleave: On Zeroing: Off	1.0 V <sub>p-p</sub>	24 GS/s	750 MHz	50 kHz	100 Hz	< -85 dBc/Hz
	Interleave: On Zeroing: On	0.5 V <sub>p-p</sub>	24 GS/s	750 MHz	50 kHz	100 Hz	< -85 dBc/Hz
AWG7122C Option 02	Direct out: On/Off	1.0 V <sub>p-p</sub>	12 GS/s	375 MHz	50 kHz	100 Hz	< -90 dBc/Hz
AWG7082C	Direct out: On/Off	1.0 V <sub>p-p</sub>	8 GS/s	250 MHz	50 kHz	100 Hz	< -90 dBc/Hz
AWG7082C Option 06	Interleave: Off	1.0 V <sub>p-p</sub>	8 GS/s	250 MHz	50 kHz	100 Hz	< -90 dBc/Hz
	Interleave: On Zeroing: Off	1.0 V <sub>p-p</sub>	16 GS/s	500 MHz	50 kHz	100 Hz	< -85 dBc/Hz
	Interleave: On Zeroing: On	0.5 V <sub>p-p</sub>	16 GS/s	500 MHz	50 kHz	100 Hz	< -85 dBc/Hz
AWG7082C Option 02	Direct out: On/Off	1.0 V <sub>p-p</sub>	8 GS/s	250 MHz	50 kHz	100 Hz	< -90 dBc/Hz

15. Press the **All Outputs On/Off** button on the instrument to turn off all the outputs.
16. Disconnect the test setup.

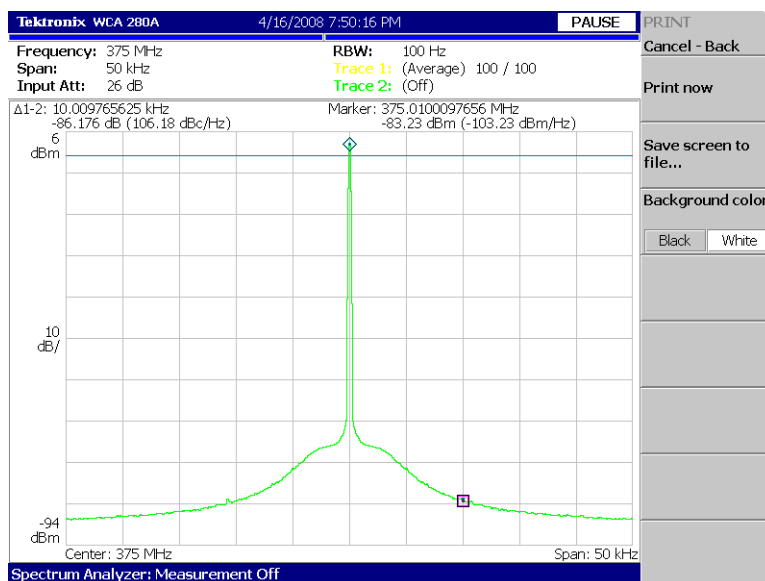
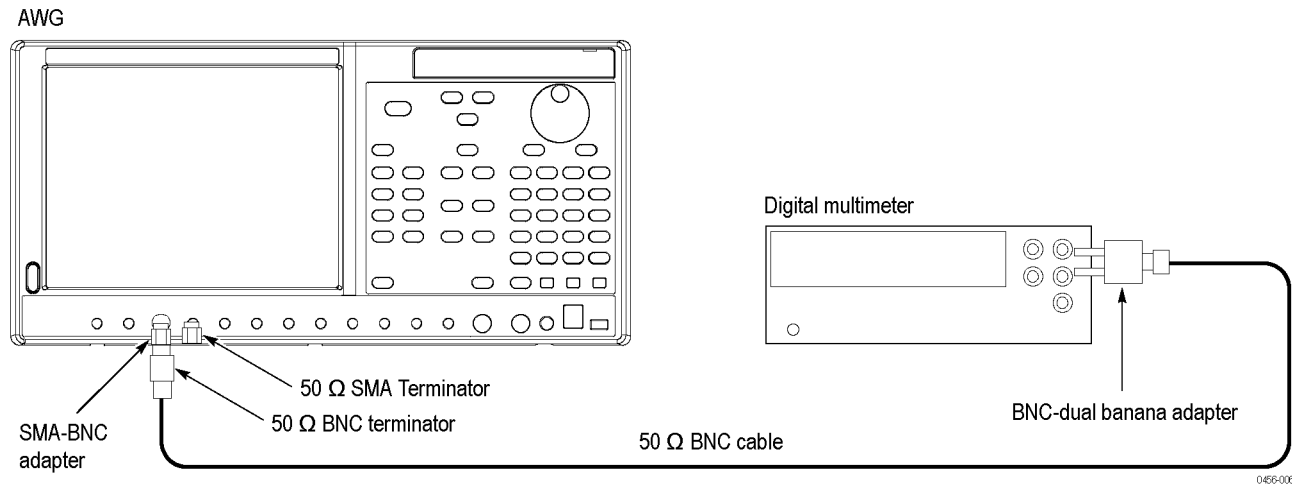

Figure 11: Example of the analog phase noise measurement

## Marker High and Low Level Accuracy

Required equipment	Prerequisites
Digital multimeter	(See page 23, <i>Prerequisites</i> .)
50 $\Omega$ BNC cable	
SMA male-BNC female adapter	
50 $\Omega$ BNC termination	
BNC-dual banana adapter	
50 $\Omega$ SMA termination	

1. Perform *Measuring Termination Resistance*. (See page 34, *Measuring the Termination Resistance*.)
2. Press the **All Outputs On/Off** button on the instrument to turn off all the outputs.
3. Use the 50  $\Omega$  BNC cable, SMA-BNC adapter, 50  $\Omega$  BNC termination, and BNC-Banana adapter to connect the Channel 1 Mkr 1 connector on the instrument to the HI and LO inputs on the digital multimeter.
4. Use the 50  $\Omega$  SMA termination to terminate the Channel 1  $\overline{\text{Mkr 1}}$  connector on the instrument.



**Figure 12: Equipment connection for verifying the marker high and low level accuracy**

5. Press the **Factory Default** button on the instrument.
6. Press the **Ch1 Select** button on the instrument.
7. On the instrument, load the **marker\_hi** waveform as an output waveform.
  - a. Select **File > Open File**.
  - b. In the dialog box, navigate to the **C:\Program Files\Tektronix\AWG\System\PV** directory, and then select the **pv\_awg7000b.awg** file. The **Waveform List** window appears.
  - c. In the window, select (drag and drop) the **marker\_hi** waveform on the **User Defined** tab.
8. Press the **Ch 1 On** button on the instrument to enable the channel 1 output.
9. Press the **Run** button on the instrument to output the waveform.
10. Make the instrument High Level setting shown in the first row of the following table:

**Table 33: Marker High and Low level accuracy**

High level settings	Accuracy limits
+ 1.4 V	1.185 V to 1.615 V
0.0 V	-75 mV to +75 mV
-0.9 V	-1.065 V to -0.735 V
Low level settings	Accuracy limits
+ 0.9 V	0.735 V to 1.065 V
0.0 V	-75 mV to +75 mV
-1.4 V	-1.615 V to -1.185 V

11. Measure the output voltage on the digital multimeter and note the value as **Measured\_voltage\_1**.

12. Use the following formula to compensate the voltage for the 50  $\Omega$  BNC termination:

$$\text{Marker\_High} = (\text{Term\_R} + 50) / (2 \text{ Term\_R}) \text{ Measured\_voltage\_1}$$

Where Term\_R is the resistance of the 50  $\Omega$  BNC termination measured in step 3 in the *Measuring the Termination Resistance*. (See page 34.)

13. Verify that the marker High level falls within the limits given in the table. (See Table 33.)

14. Repeat steps 10 through 13 for each row in the table. (See Table 33.)

15. In the **Waveform List** window, select the **marker\_low** waveform on the **User Defined** tab.

16. Press the **Ch 1 On** button on the instrument to enable the channel 1 output.

17. Press the **Run** button on the instrument to output the waveform.

18. Make the instrument Low Level setting shown in the first row of the table. (See Table 33.)

19. Measure the output voltage on the digital multimeter and note the value as **Measured\_voltage\_2**.

20. Use the following formula to compensate the voltage for the 50  $\Omega$  BNC termination:

$$\text{Marker\_Low} = (\text{Term\_R} + 50) / (2 \text{ Term\_R}) \text{ Measured\_voltage\_2}$$

21. Verify that the marker Low level falls within the limits given in the table. (See Table 33.)

22. Repeat steps 18 through 21 for each row in the table. (See Table 33.)

23. Press the **Ch 1 On** button to disable the channel 1 output.

24. Move the SMA-BNC adapter from the Channel 1 Mkr 1 connector to the Channel 1  $\overline{\text{Mkr 1}}$  connector and move the 50  $\Omega$  SMA termination from the Channel 1 Mkr 2 connector to the Channel 1  $\overline{\text{Mkr 2}}$  connector.

---

**NOTE.** For the  $\overline{\text{Mkr 1}}$  output, read marker\_hi and marker\_low as marker\_low and marker\_hi respectively.

---

25. Repeat steps 8 through 22.

26. Repeat steps 8 through 25 for Channel 1 Mkr 2 and  $\overline{\text{Mkr 2}}$ .

27. Repeat the test for the Channel 2 marker outputs.

28. Press the **All Outputs On/Off** button on the instrument to turn off all the outputs.
29. Disconnect the test setup.

## Marker Output Delay Accuracy

Required equipment	Prerequisites
Sampling oscilloscope	(See page 23, <i>Prerequisites</i> .)
Two 50 $\Omega$ SMA cables	
Two 50 $\Omega$ SMA terminations	
Two 50 $\Omega$ SMA attenuators	

1. Press the **All Outputs On/Off** button on the instrument to turn off all the outputs.
2. Use a 50  $\Omega$  SMA cable and 50  $\Omega$  SMA attenuator to connect the Channel 1 Mkr 1 connector on the instrument to the CH1 connector on the sampling oscilloscope.
3. Use the 50  $\Omega$  SMA cable and 50  $\Omega$  SMA attenuator to connect the Channel 1 Analog connector on the instrument to the TRIGGER DIRECT connector on the sampling oscilloscope.
4. Use a 50  $\Omega$  SMA termination to terminate the Channel 1  $\overline{\text{Analog}}$  connector on the instrument.
5. Use the 50  $\Omega$  SMA termination to terminate the Channel 1  $\overline{\text{Mkr 1}}$  connector on the instrument.

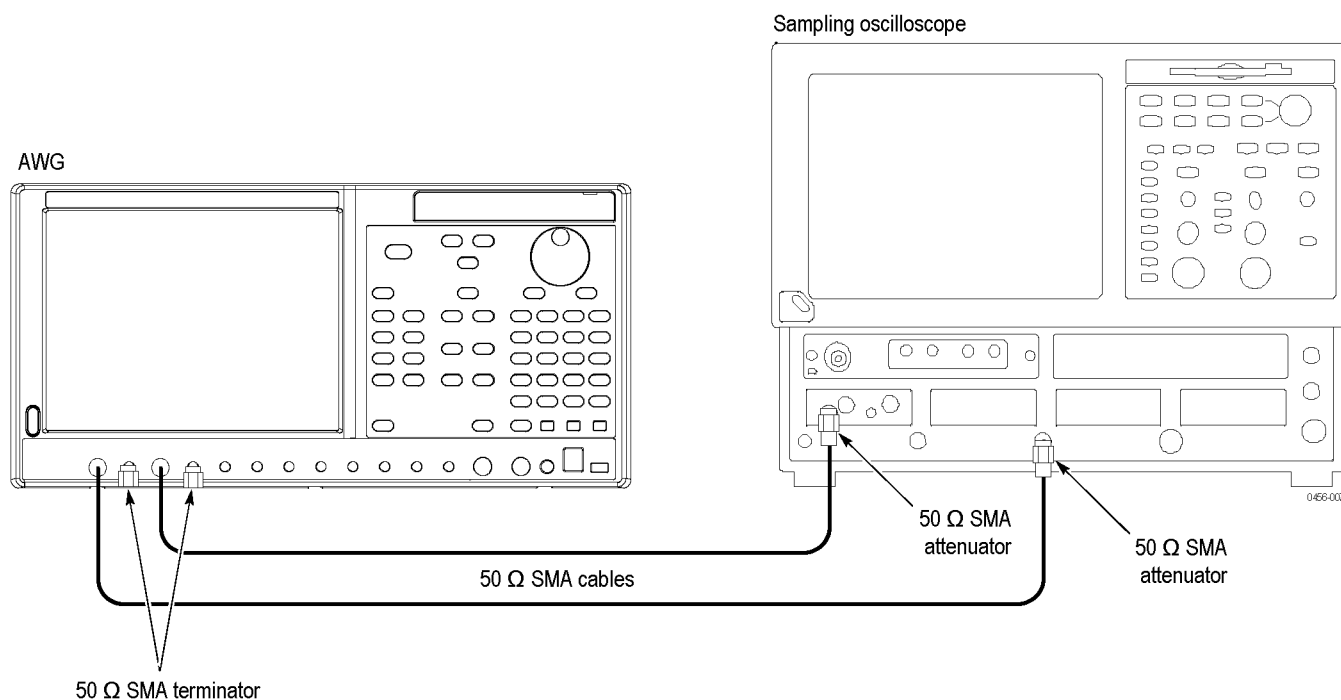

**Figure 13: Equipment connections for verifying the marker output delay accuracy**

6. Set the sampling oscilloscope as follows:
  - a. Vertical scale: 50 mV/div
  - b. Horizontal scale: 100 ps/div
  - c. Trigger source: External Direct
  - d. Trigger level: 0 V
  - e. Trigger slope: positive
  - f. Measure: Pulse measurement > Pulse Time > Delay
7. Press the **Factory Default** button on the instrument.
8. On the instrument, load the **square1** waveform as an output waveform.
  - a. Select **File > Open File**.
  - b. In the dialog box, navigate to the **C:\Program Files\Tektronix\AWG\System\PV** directory, and then select the **pv\_awg7000b.awg** file. The **Waveform List** window appears.
  - c. In the window, select the **square1** waveform on the **User Defined** tab.
9. Press the **Ch 1 On** button on the instrument to enable the channel 1 output.
10. Press the **Run** button on the instrument to output the waveform.

11. On the oscilloscope, store the channel 1 waveform to **Ref 1** as a reference waveform.
12. On the instrument, set the **Marker 1** delay value to **150 ps**.
13. Use the oscilloscope to measure the delay time between the Ref 1 waveform and channel 1 waveform at the 50% level.
14. Verify that the delay time is within the range of 92.5 ps to 207.5 ps.
15. Press the **Ch 1 On** button on the instrument to disable the channel 1 output.
16. Move the SMA cable from the Channel 1 Mkr 1 connector to the Channel 1 Mkr 2 connector.
17. Move the SMA termination from the Channel 1  $\overline{\text{Mkr 1}}$  connector to the Channel 1  $\overline{\text{Mkr 2}}$  connector.
18. Press the **Ch 1 On** button on the instrument to enable the channel 1 output.
19. On the oscilloscope, store the channel 1 waveform to **Ref 1** as a reference waveform.
20. On the instrument, set the **Marker 2** delay value to **150 ps**.
21. Repeat steps 13 and 14.
22. Repeat the test for the Marker 1 and Marker 2 of the Channel 2.
23. Press the **All Outputs On/Off** button on the instrument to turn off all the outputs.
24. Disconnect the test setup.

## DC Output Voltage Accuracy

Required equipment	Prerequisites
Digital multimeter	(See page 23, <i>Prerequisites</i> .)
DC output lead set	
Test leads (provided with the digital multimeter)	

1. Use the test leads to connect the HI and LO inputs on the digital multimeter.
2. Use the DC output lead set to connect the DC Output connector on the instrument.



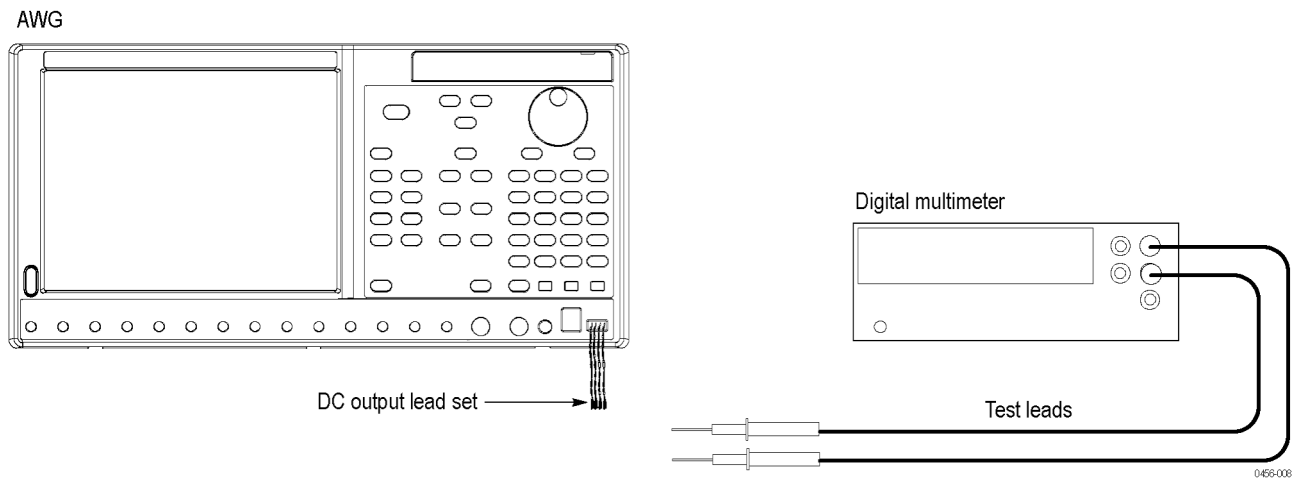

Figure 14: Equipment connection for verifying the DC output voltage accuracy

3. Set the digital multimeter to the **VDC** mode.
4. On the instrument, select the **DC Outputs** tab in the **Settings** window.
5. On the DC Output tab, set the DC 1, DC 2, DC 3, and DC 4 levels to the setting shown in the first row of the following table:

Table 34: DC output voltage accuracy

DC output settings	Accuracy limits
+5 V	4.73 V to 5.27 V
+3 V	2.79 V to 3.21 V
0.0 V	-120 mV to +120 mV
-3 V	-3.21 V to -2.79 V

6. On the DC Outputs tab, select the **DC Output** check box to enable the DC output. The DC Output LED on the front panel lights.
7. Attach the black test lead to the connector lead from DC1 GND.
8. Attach the red test lead to the connector lead from DC1.
9. Verify that the DC output level falls within the limits given in the table.
10. Repeat steps 8 through 9 for DC 2, DC 3, and DC 4.
11. Repeat steps 5 through 10 for each row.

This completes the performance verification.