

Operating Manual



Spektrum Analyzer

R&S® FSP3

1164.4391.03

R&S® FSP30

1164.4391.30/39

R&S® FSP7

1164.4391.07

R&S® FSP31

1164.4391.31

R&S® FSP13

1164.4391.13

R&S® FSP40

1164.4391.40

Volume 1

This Operating Manual consists of 2 volumes

Printed in the Federal
Republic of Germany

ROHDE & SCHWARZ
Test and Measurement Division

Dear Customer,

throughout this operating manual, the abbreviation FSP is used for your Spectrum Analyzer R&S FSP.

R&S® is a registered trademark of Rohde & Schwarz GmbH & Co. KG

Trade names are trademarks of the owners

Tabbed Divider Overview

Volume 1

Data Sheet

Safety Instructions
Certificate of Quality
EU Certificate of Conformity
List of R&S Representatives

Manuals for Spectrum Analyzer FSP

Tabbed Divider

1	Chapter 1:	Putting into Operation
2	Chapter 2:	Getting Started
3	Chapter 3:	Operation
4	Chapter 4:	Functional Description
10	Chapter 10:	Index

Volume 2

Data Sheet

Safety Instructions

Manuals for Spectrum Analyzer FSP

Tabbed Divider

5	Chapter 5:	Remote Control – Basics
6	Chapter 6:	Remote Control – Commands
7	Chapter 7:	Remote Control – Program Examples
8	Chapter 8:	Maintenance and Hardware Interfaces
9	Chapter 9:	Error Messages
10	Chapter 10:	Index



Certificate No.: 2003-22

This is to certify that:

Equipment type	Stock No.	Designation
FSP3	1164.4391.03	Spectrum Analyzer
FSP7	1164.4391.07	
FSP13	1164.4391.13	
FSP30	1164.4391.30	
FSP31	1164.4391.31	
FSP40	1164.4391.40	
FSP-B3	1129.6491.02	Audio Modulator AM/FM
FSP-B4	1129.6740.02	OCXO 10 MHz
FSP-B6	1129.8594.02	TV-Trigger
FSP-B9	1129.6991.02	Tracking Generator
FSP-B10	1129.7246.02	External Generator Control
FSP-B15	1155.1006.02	Pulse Calibrator
FSP-B16	1129.8042.03	Lan Interface 10/1000 Base T
FSP-B20	1155.1606.02	Extended Environmental Spec
FSP-B25	1129.7746.02	Electronic Attenuator
FSP-B28	1162.9915.02	Trigger Port
FSP-B30	1155.1158.02	DC Power Supply
FSP-B31	1155.1258.02	NIMH Battery Pack and Charger
FSP-B32	1155.1506.02	Spare Battery Pack (NIMH)
FSP-B70	1157.0559.02	Demodulator HW and Memory Extension

complies with the provisions of the Directive of the Council of the European Union on the approximation of the laws of the Member States

- relating to electrical equipment for use within defined voltage limits (73/23/EEC revised by 93/68/EEC)
- relating to electromagnetic compatibility (89/336/EEC revised by 91/263/EEC, 92/31/EEC, 93/68/EEC)

Conformity is proven by compliance with the following standards:

EN61010-1 : 1993 + A2 : 1995
EN55011 : 1998 + A1 : 1999
EN61326 : 1997 + A1 : 1998 + A2 : 2001

For the assessment of electromagnetic compatibility, the limits of radio interference for Class B equipment as well as the immunity to interference for operation in industry have been used as a basis.

Affixing the EC conformity mark as from 2003

Munich, 2004-04-15









ROHDE & SCHWARZ GmbH & Co. KG
Mühldorfstr. 15, D-81671 München
Central Quality Management FS-QZ / Becker

Safety Instructions

This unit has been designed and tested in accordance with the EC Certificate of Conformity and has left the manufacturer's plant in a condition fully complying with safety standards.

To maintain this condition and to ensure safe operation, the user must observe all instructions and warnings given in this operating manual.

Safety-related symbols used on equipment and documentation from R&S:

							
Observe operating instructions	Weight indication for units >18 kg	PE terminal	Ground terminal	Danger! Shock hazard	Warning! Hot surfaces	Ground	Attention! Electrostatic sensitive devices require special care

- The unit may be used only in the operating conditions and positions specified by the manufacturer. Unless otherwise agreed, the following applies to R&S products:
IP degree of protection 2X, pollution severity 2 overvoltage category 2, only for indoor use, altitude max. 2000 m.
The unit may be operated only from supply networks fused with max. 16 A.
Unless specified otherwise in the data sheet, a tolerance of $\pm 10\%$ shall apply to the nominal voltage and of $\pm 5\%$ to the nominal frequency.
- For measurements in circuits with voltages $V_{\text{rms}} > 30 \text{ V}$, suitable measures should be taken to avoid any hazards.
(using, for example, appropriate measuring equipment, fusing, current limiting, electrical separation, insulation).
- If the unit is to be permanently wired, the PE terminal of the unit must first be connected to the PE conductor on site before any other connections are made. Installation and cabling of the unit to be performed only by qualified technical personnel.
- For permanently installed units without built-in fuses, circuit breakers or similar protective devices, the supply circuit must be fused such as to provide suitable protection for the users and equipment.
- Prior to switching on the unit, it must be ensured that the nominal voltage set on the unit matches the nominal voltage of the AC supply network.
If a different voltage is to be set, the power fuse of the unit may have to be changed accordingly.
- Units of protection class I with disconnectible AC supply cable and appliance connector may be operated only from a power socket with earthing contact and with the PE conductor connected.
- It is not permissible to interrupt the PE conductor intentionally, neither in the incoming cable nor on the unit itself as this may cause the unit to become electrically hazardous.
Any extension lines or multiple socket outlets used must be checked for compliance with relevant safety standards at regular intervals.
- If the unit has no power switch for disconnection from the AC supply, the plug of the connecting cable is regarded as the disconnecting device. In such cases it must be ensured that the power plug is easily reachable and accessible at all times (length of connecting cable approx. 2 m). Functional or electronic switches are not suitable for providing disconnection from the AC supply.
If units without power switches are integrated in racks or systems, a disconnecting device must be provided at system level.
- Applicable local or national safety regulations and rules for the prevention of accidents must be observed in all work performed.
Prior to performing any work on the unit or opening the unit, the latter must be disconnected from the supply network.
Any adjustments, replacements of parts, maintenance or repair may be carried out only by authorized R&S technical personnel.
Only original parts may be used for replacing parts relevant to safety (eg power switches, power transformers, fuses). A safety test must be performed after each replacement of parts relevant to safety.
(visual inspection, PE conductor test, insulation-resistance, leakage-current measurement, functional test).

continued overleaf

Safety Instructions

10. Ensure that the connections with information technology equipment comply with IEC950 / EN60950.
11. Lithium batteries must not be exposed to high temperatures or fire.
Keep batteries away from children.
If the battery is replaced improperly, there is danger of explosion. Only replace the battery by R&S type (see spare part list).
Lithium batteries are suitable for environmentally-friendly disposal or specialized recycling. Dispose them into appropriate containers, only.
Do not short-circuit the battery.
12. Equipment returned or sent in for repair must be packed in the original packing or in packing with electrostatic and mechanical protection.
13. Electrostatics via the connectors may damage the equipment. For the safe handling and operation of the equipment, appropriate measures against electrostatics should be implemented.
14. The outside of the instrument is suitably cleaned using a soft, lint-free dustcloth. Never use solvents such as thinners, acetone and similar things, as they may damage the front panel labeling or plastic parts.
15. Any additional safety instructions given in this manual are also to be observed.

Contents of Manuals for Spectrum Analyzer FSP

Operating Manual FSP

The operating manual describes the following models and options of spectrum analyzer FSP:

- FSP3 9 kHz to 3 GHz
- FSP7 9 kHz to 7 GHz
- FSP13 9 kHz to 13.6 GHz
- FSP30 9 kHz to 30 GHz
- FSP31 9 kHz to 31 GHz
- FSP40 9 kHz to 40 GHz

- Option FSP B3 audio demodulator
- Option FSP-B4 OCXO - reference oscillator
- Option FSP-B9 tracking generator
- Option FSP-B10 external generator control
- Option FSP-B15 pulse calibrator
- Option FSP-B16 LAN interface
- Option FSP-B25 electronic attenuator
- Option FSP-B28 trigger port

This operating manual contains information about the technical data of the instrument, the setup functions and about how to put the instrument into operation. It informs about the operating concept and controls as well as about the operation of the FSP via the menus and via remote control. Typical measurement tasks for the FSP are explained using the functions offered by the menus and a selection of program examples.

Additionally the operating manual includes information about maintenance of the instrument and about error detection listing the error messages which may be output by the instrument. It is subdivided into 9 chapters:

- | | |
|-------------------|-------------------------------------------------------------------------------------------------------------------------------------------------------------------------------------------------------------------------------------|
| Chapter 1 | describes the control elements and connectors on the front and rear panel as well as all procedures required for putting the FSP into operation and integration into a test system. |
| Chapter 2 | gives an introduction to typical measurement tasks of the FSP which are explained step by step. |
| Chapter 3 | describes the operating principles, the structure of the graphical interface and offers a menu overview. |
| Chapter 4 | forms a reference for manual control of the FSP and contains a detailed description of all instrument functions and their application. The chapter also lists the remote control command corresponding to each instrument function. |
| Chapter 5 | describes the basics for programming the FSP, command processing and the status reporting system. |
| Chapter 6 | lists all the remote-control commands defined for the instrument. |
| Chapter 7 | contains program examples for a number of typical applications of the FSP. |
| Chapter 8 | describes preventive maintenance and the characteristics of the instrument's interfaces. |
| Chapter 8 | gives a list of error messages that the FSP may generate. |
| Chapter 9 | contains a list of error messages. |
| Chapter 10 | contains an index for the operating manual. |

Service Manual - Instrument

The service manual - instrument informs on how to check compliance with rated specifications, on instrument function, repair, troubleshooting and fault elimination. It contains all information required for the maintenance of FSP by exchanging modules.

Contents - Chapter 1 " Preparing for Operation "

1 Preparing for Operation	1.1
Description of Front and Rear Panel Views	1.1
Front View.....	1.1
Rear View	1.9
Getting Started with the Instrument.....	1.14
Preparing the Instrument for Operation	1.14
Setting Up the Instrument.....	1.14
Standalone Operation.....	1.14
Safety Instruction for Instruments with Tilttable Feet	1.15
Rackmounting	1.15
EMC Safety Precautions.....	1.16
Connecting the Instrument to the AC Supply.....	1.16
Switching the Instrument On/Off.....	1.16
Switching On the Instrument	1.17
Startup Menu and Booting.....	1.17
Switching Off the FSP	1.17
Power-Save Mode	1.18
Recalling the Most Recent Instrument Settings.....	1.18
Function Test	1.18
Windows XP	1.19
Connecting an External Keyboard	1.20
Connecting a Mouse.....	1.21
Connecting an External Monitor	1.22
Connecting a Printer.....	1.23
Selecting a Printer	1.23
Installation of Plug&Play Printers.....	1.26
Installation of Non-Plug&Play Printers.....	1.26
Local Printer	1.28
Configuring a Network Printer (with Option FSP-B16 only)	1.33
Connection of USB Devices	1.35
Installing Windows XP Software	1.37
Authorized Windows XP Software for the Instrument	1.37

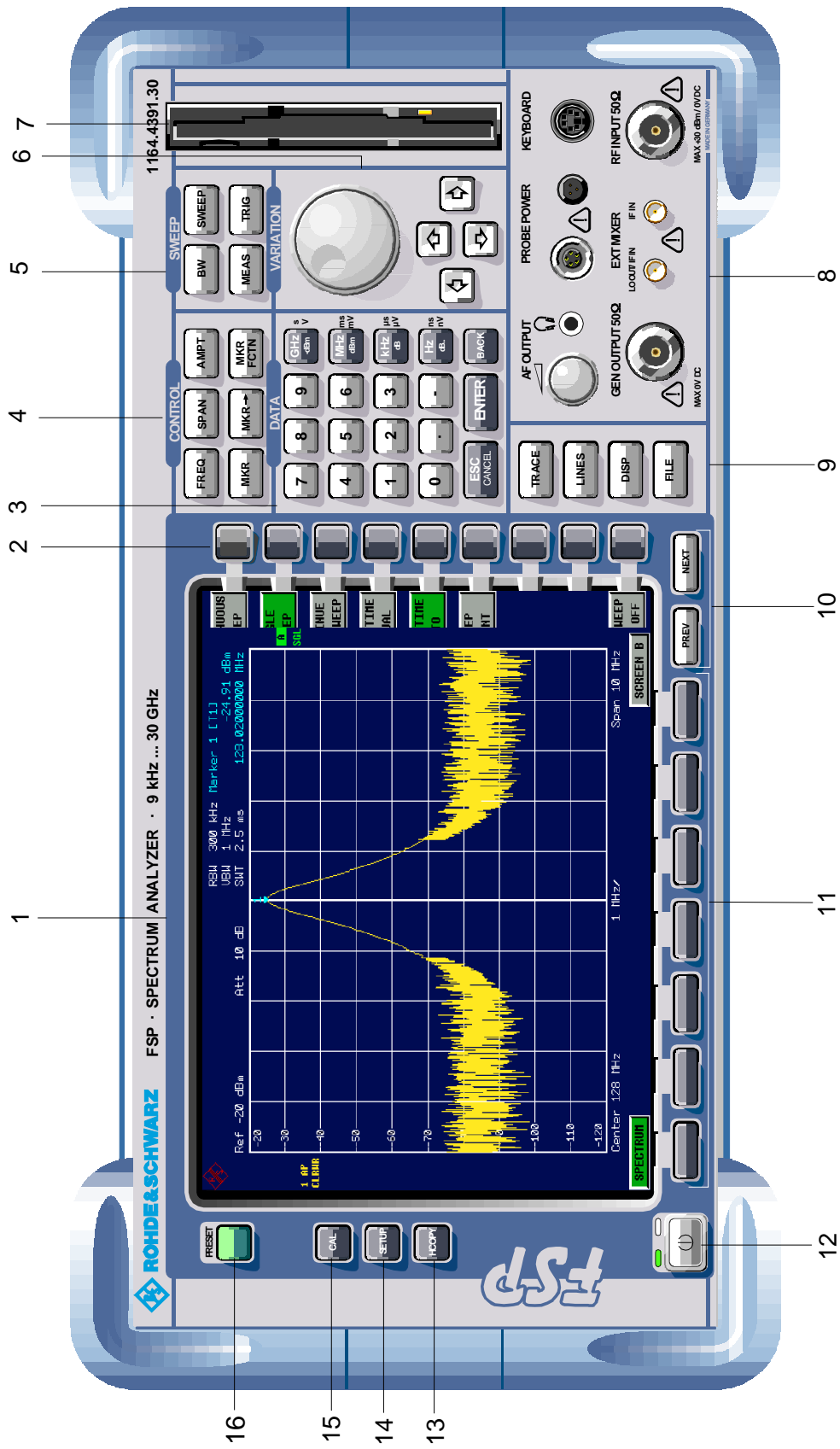

Fig. 1-1 Front View

1 Preparing for Operation

Chapter 1 describes the controls and connectors of the Spectrum Analyzer FSP by means of the front and rear view. Then follows all the information that is necessary to put the instrument into operation and connect it to the AC supply and to external devices.

A more detailed description of the hardware connectors and interfaces can be found in chapter 8. Chapter 2 provides an introduction into the operation of the FSP by means of typical examples of configuration and measurement; for the description of the concept for manual operation and an overview of menus refer to chapter 3.

For a systematic explanation of all menus, functions and parameters and background information refer to the reference part in chapter 4.

For remote control of the FSP refer to the general description of the SCPI commands, the instrument model, the status reporting system, and command description in chapter 5 and 6.

Description of Front and Rear Panel Views

Front View

1	Display Screen	see Chapter 3
2	Softkeys	see Chapter 3
3		<p>data input</p> <p>0...9 input numbers</p> <p>. input decimal point</p> <p>- change sign</p> <p>ESC – close input field (for uncompleted or already closed inputs, the original entry is kept)</p> <p>CANCEL – erase the current entry in input field (beginning of an input)</p> <p>– close message window (status, error and warning messages)</p> <p>ENTER close the data input.</p> <p>BACK – erase last character input for uncompleted input</p> <p>– restore previous input (undo)</p> <p style="text-align: right;">see Chapter 3</p>

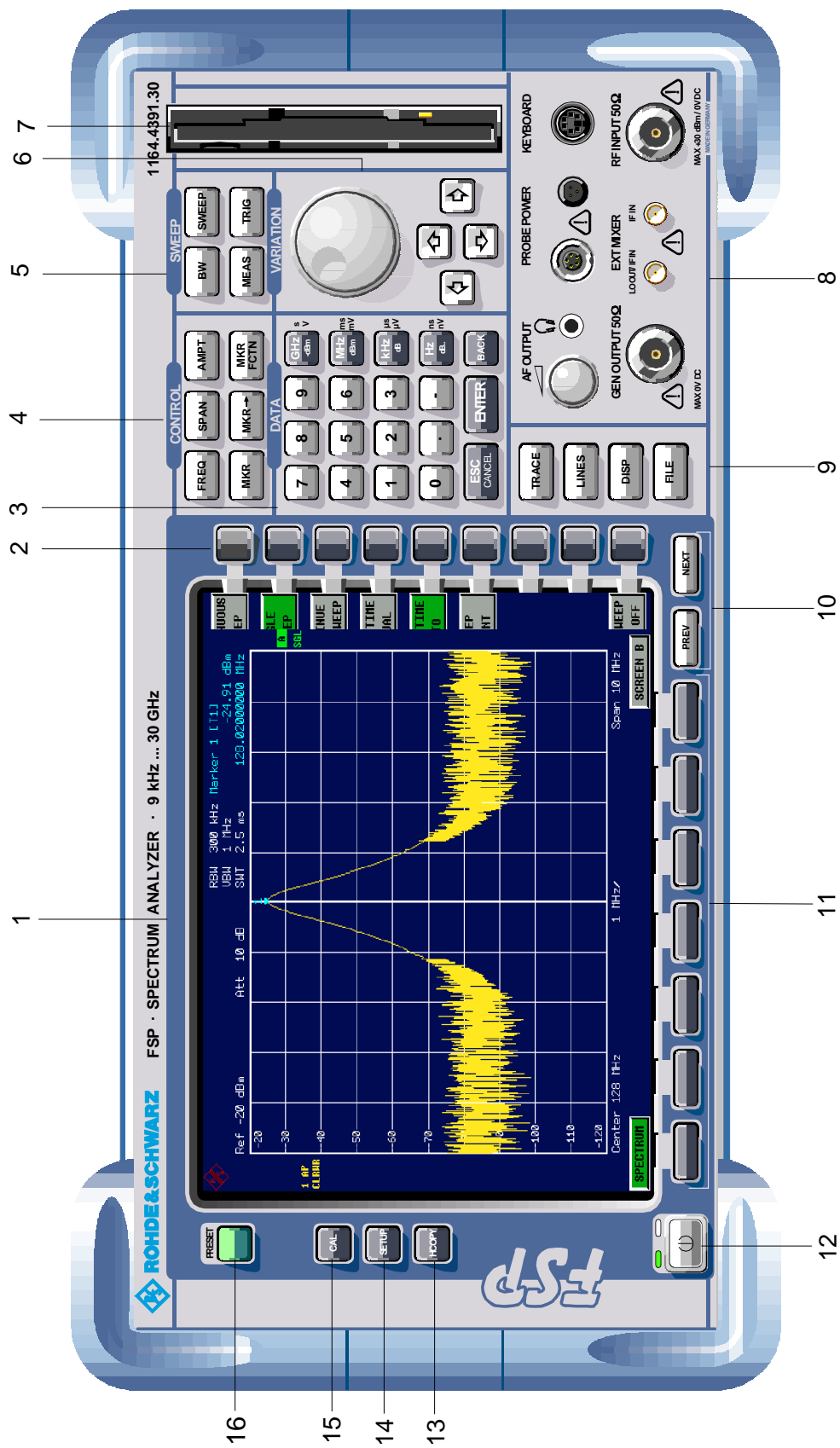

Fig. 1-1 Front View



data input

GHz s The units keys close the data input and define the multiplication factor for each basic unit.

-dBm V For dimension-less or alphanumeric inputs, the units keys have weight 1.

MHz ms They behave, in this case, like the ENTER key.

dBm mV

KHz μs

dB μV

Hz ns

dB.. nV

see Chapter 3

4



FREQ Set frequency axis

SPAN Set span

AMPT Set level indication and configure RF input.

MKR Select and set standard marker and delta marker functions.

MKR-> Change instrument settings via markers

MKR Select further marker and delta

FCTN marker functions

see Chapter 4

5



BW – Set resolution bandwidth, video bandwidth and sweep time, – Set coupling of these parameters

SWEEP Select sweep

MEAS Select and set power measurements

TRIG Set trigger sources

see Chapter 4

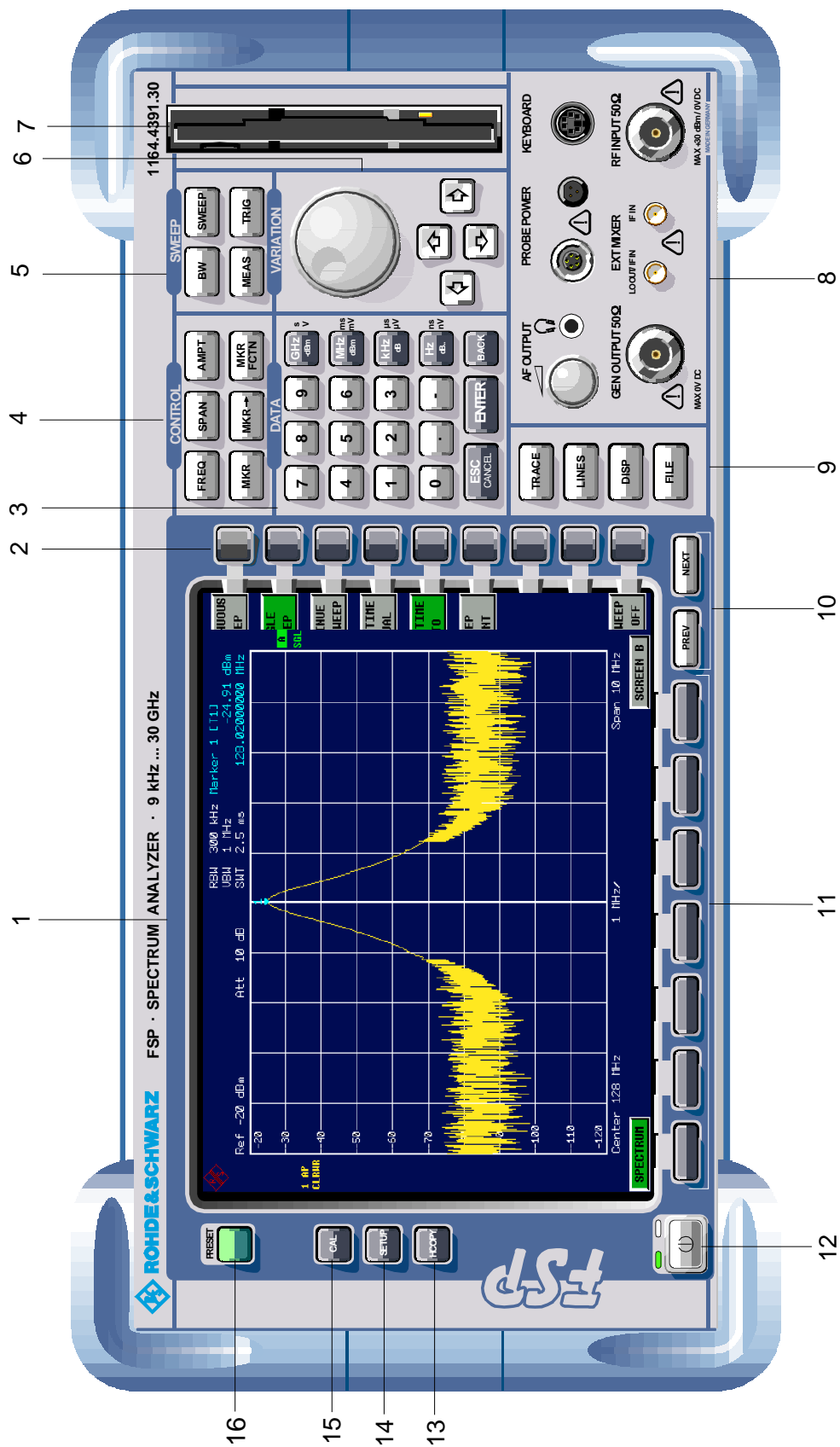

Fig. 1-1 Front View

6



Key group for entering data and for cursor movement

see Chapter 3

- Cursor keys – Move the cursor within the input fields and tables.
- Vary the input value.
 - Define the direction of movement for the roll-key.

- Roll-key – Vary input values.
- Move markers and limits.
 - Select letters in the help line editor.
 - Move cursor in the tables
 - Close data input (ENTER)

7

3 1/2" diskette drive; 1.44 MByte

8



AF OUTPUT (only with option FSP-B3)

see Chapter 8

- Volume control
- Head phone connector

PROBE POWER Power supply and coded socket (+15 V/ -12 V) for accessories

KEYBOARD Connector for an external keyboard

RF INPUT RF input

see Chapter 8



Caution:

For FSP3 and FSP7 The maximum DC voltage is 50 V, the maximum power is 1 W ($\hat{=}$ 30 dBm) at \geq 10 dB attenuation. For all other models, the maximum DC voltage is 0 V, the maximum power is 1 W (30 dBm at \geq 30 dB attenuation)

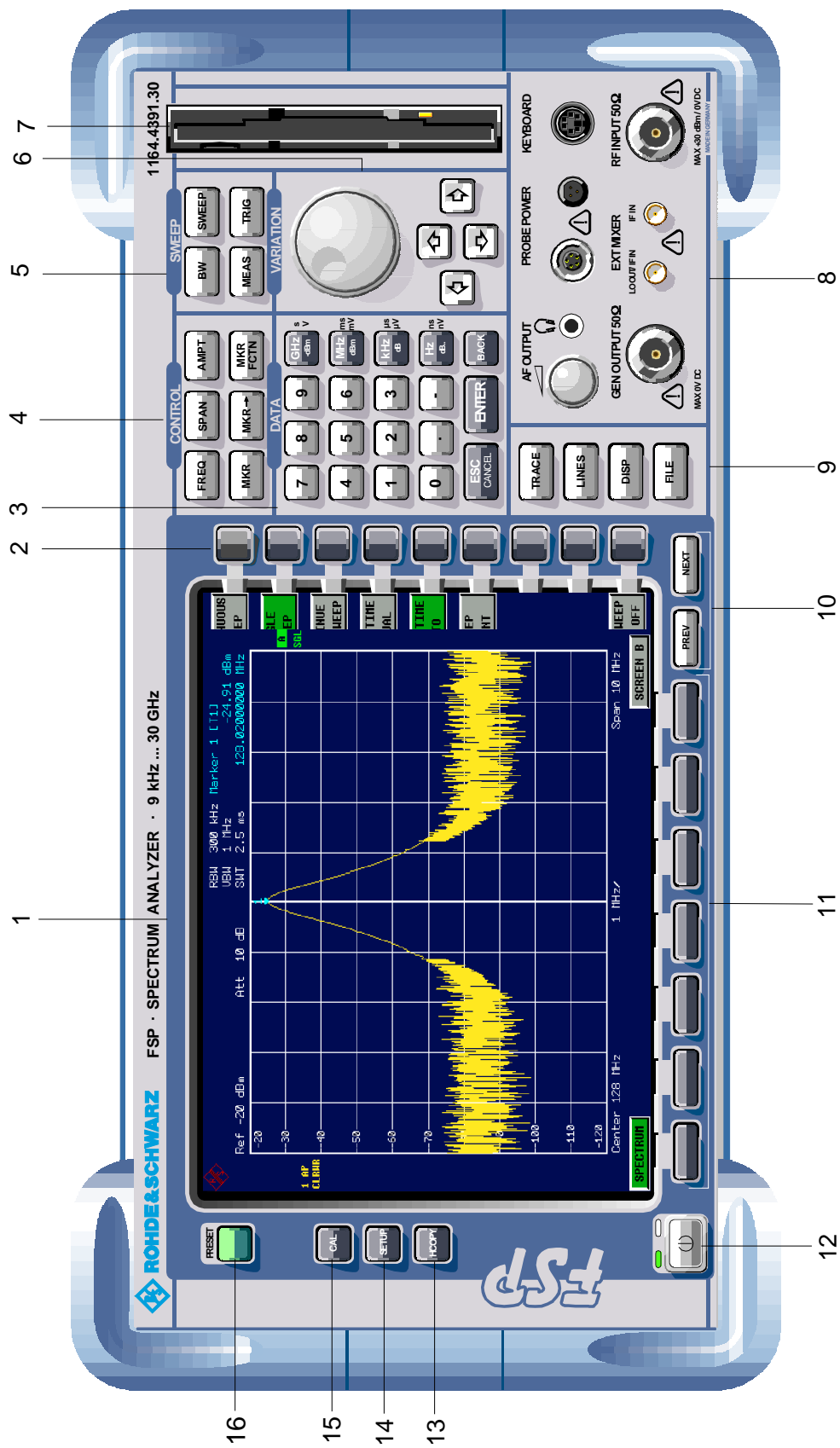

Fig. 1-1 Front View

9



TRACE Select and activate traces and detectors
 LINES Set limit lines
 DISP Configure display
 FILE – Save and recall instrument data
 – Configuration of memory media and data

see Chapter 4

10



Menu-change keys
 NEXT Change to side menu
 PREV Call main menu

see Chapter 3

11

Hotkeys

see Chapter 3

12



ON/STANDBY switch

see Chapter 1

13



Configure and start a print job

see Chapters 1 and 4

14



Define general configuration

see Chapter 4

15



Record correction data

see Chapter 4

16



Call default settings

see Chapter 4

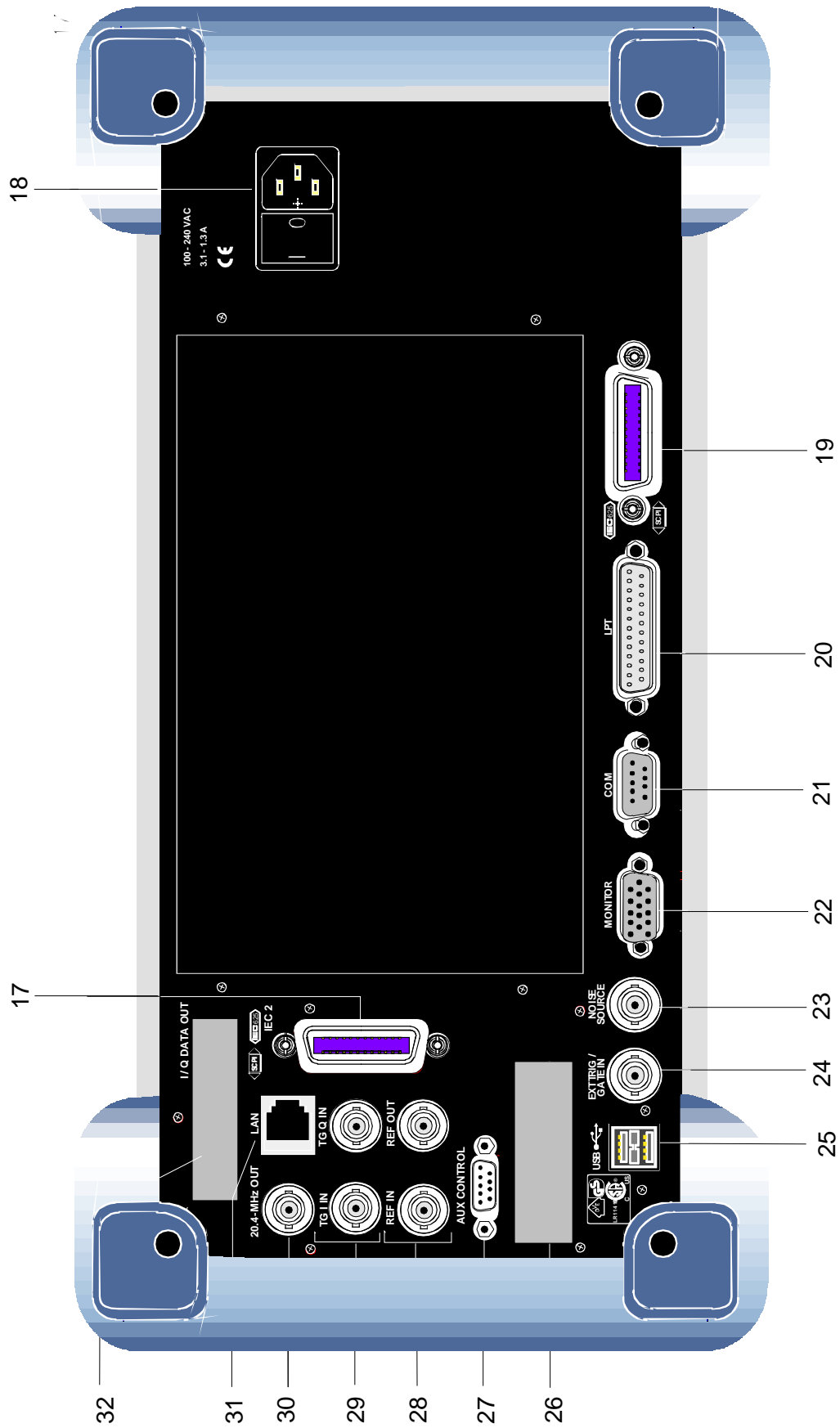

Fig. 1-1 Rear View

Rear View

17

Reserved for options

see Chapter 8

18

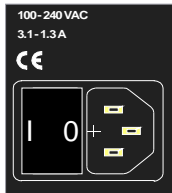

Power switch and AC power connector

see Chapter 1

19

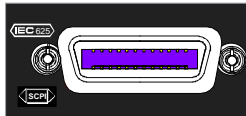

IEC/IEEE bus-connector

see Chapter 8

20

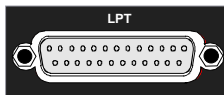
Parallel interface connector
(printer connector)

see Chapter 8

21

Connector for a serial interface
(9-pin socket; COM)

see Chapter 8

22



Connector for an external monitor

see Chapter 8

23



Output connector for an external noise source

see Chapter 8

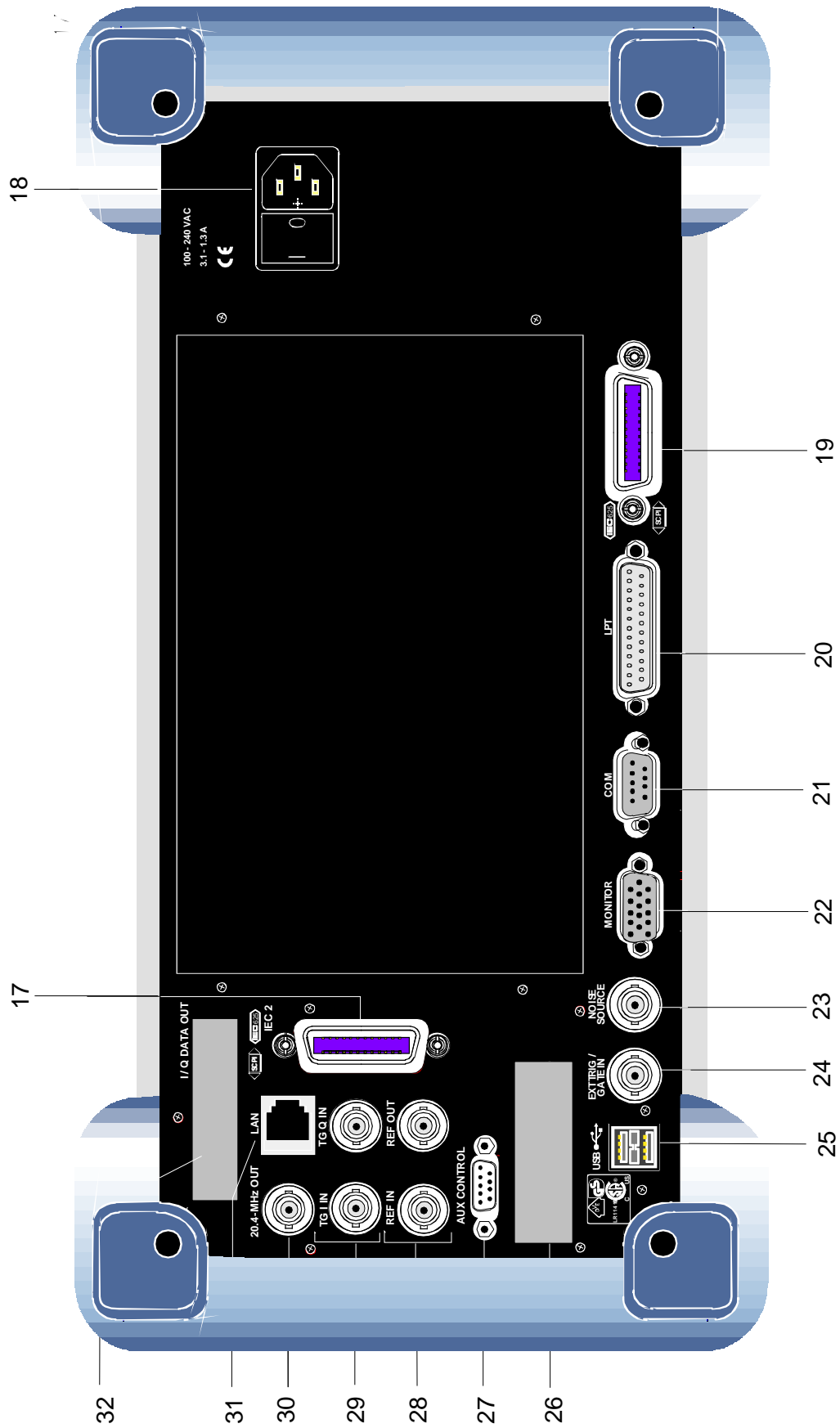

Fig. 1-2 Rear View

24



Input connector for an external trigger or an external gate signal

see Chapter 8

25

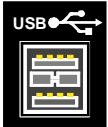

Connector for USB

see Chapter 8

26

Reserved for options

27



Connector to control an external generator ((only with option FSP-B10)

28

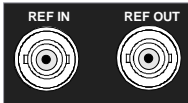

REF IN Input connector for an external reference (10 MHz)
REF OUT Output connector for an internal reference (10 MHz)

see Chapter 4



Bild 1-2 Rear View

29

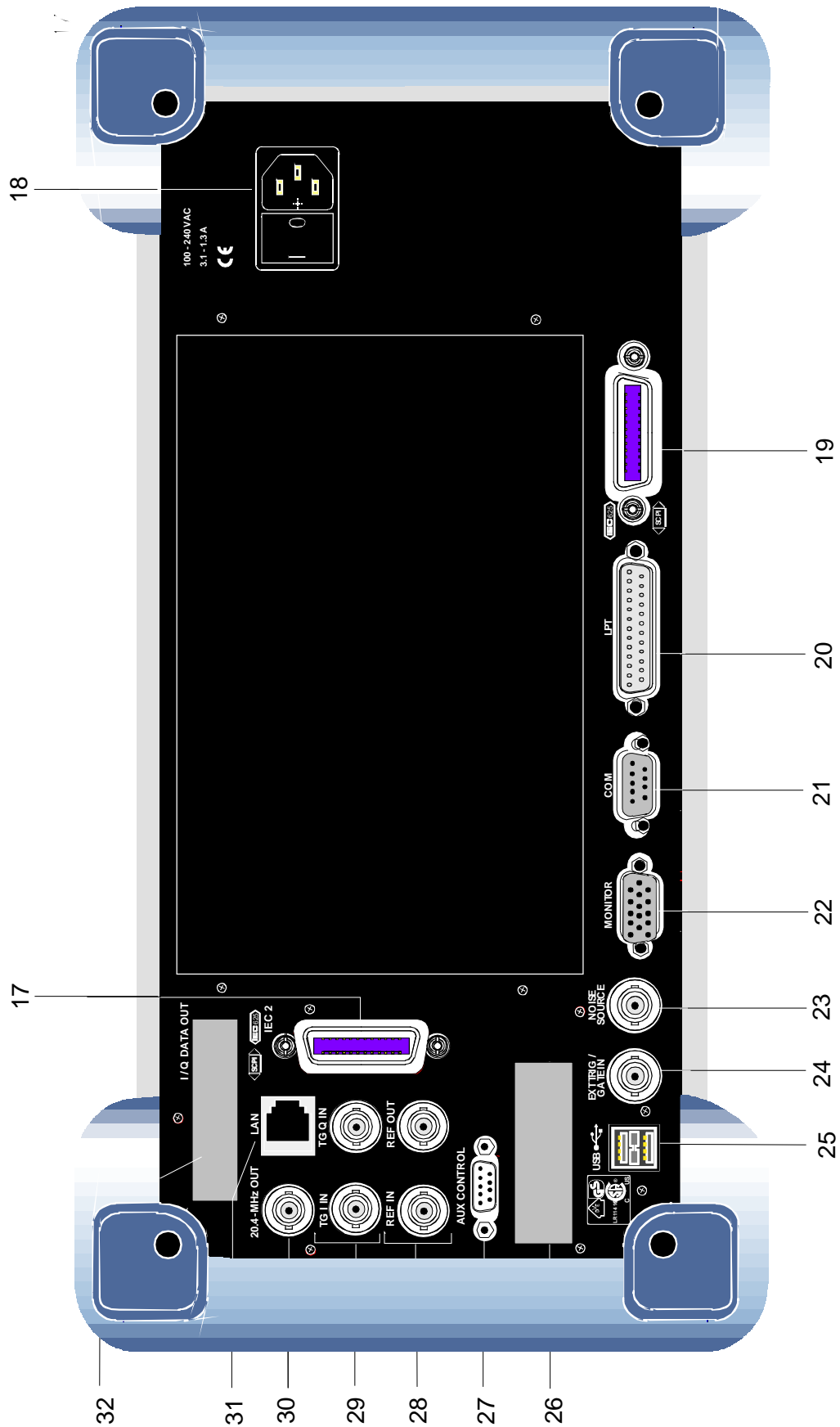
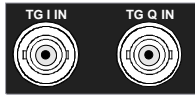

TG IN Signal input connector for external modulation of Tracking Generator (option FSP-B9)

TG Q IN Signal input connector for external modulation of Tracking Generator (option FSP-B9)

30



Output connector for 20.4 MHz IF
(replaced by CCVS IN OUT if option FSP-B6 is built in)

see Chapter 8



Selectable CCVS input/output
(only if option FSP-B6 is built in)

see Chapter 4 and 8

31



LAN Interface (option FSP-B16)

see Chapter 4

32

Reserved for options

Getting Started with the Instrument

The following section describes how to activate the instrument and how to connect external devices such as printer and monitor.

Chapter 2 explains the operation of the instrument using simple measurement examples.



Important:

Prior to switching on the instrument, make sure that the following conditions are fulfilled:

- The instrument cover is in place and tightly screwed on
- Fan openings are not obstructed
- Signal levels at the inputs are within specified limits
- Signal outputs are connected correctly and not overloaded.

Any non-compliance may cause damage to the instrument .

Preparing the Instrument for Operation

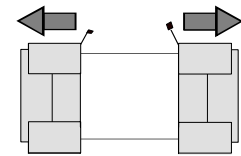

remove protective caps

- Take the instrument out of the packaging and check whether the items listed in the packing list and in the lists of accessories are all included.
- Remove the two protective covers from the front and rear of the FSP and carefully check the instrument for damage.
- Should the instrument be damaged, immediately notify the carrier and keep the box and packing material.
- For further transport or shipment of the FSP, the original packing should be used. It is recommended to keep at least the two protective covers of the front and rear panels in order to prevent damage to the controls and connectors.

Setting Up the Instrument

Standalone Operation

The instrument is designed for use under general laboratory conditions. The ambient conditions required at the site of operation are as follows:

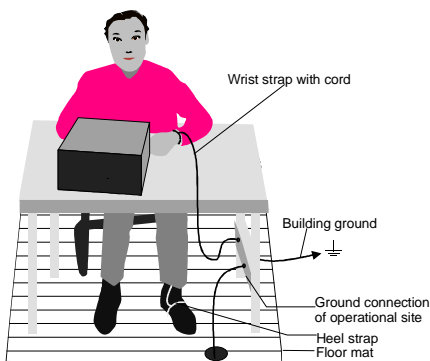

- The ambient temperature must be in the range specified in the data sheet.
- All fan openings must be unobstructed and the air flow at the rear panel and at the side-panel perforations must be unimpeded. The distance to the wall should be at least 10 cm.
- The mounting surface should be flat.
- To avoid damage of electronic components of the DUT due to electrostatic discharge on manual touch, protective measures against electrostatic discharge are recommended.

Safety Instruction for Instruments with Tilttable Feet



Warning

The feet must be fully folded in or out. Only in this way can the stability of the instrument be guaranteed and reliable operation be ensured. With the feet out, the total load for the feet must not exceed 500 N (own weight and additional units put onto the instrument). These units must be secured against slipping (e.g. by locking the feet of the unit at the top side of the enclosure).

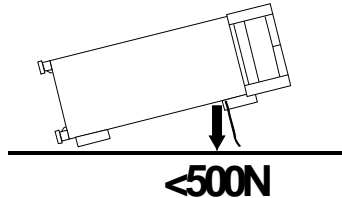

When shifting the instrument with the feet out, the feet might collapse and fold in. To avoid injuries, the instrument must therefore not be shifted with the feet out.

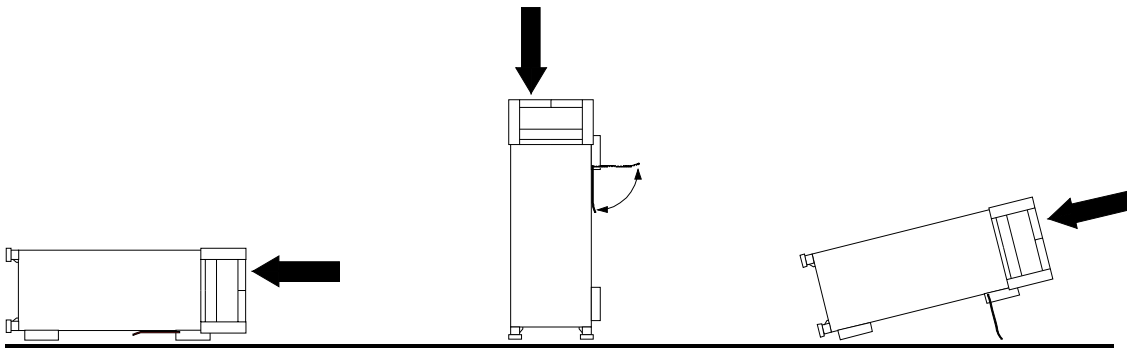

The instrument can be operated in any position.

Rackmounting



Important:

For rack installation, ensure that the air flow at the side-panel perforations and the air exhaust at the rear panel are not obstructed.

The instrument may be installed in a 19" rack by using a rack adapter kit (Order No. see data sheet). The installation instructions are part of the adapter kit.

EMC Safety Precautions

In order to avoid electromagnetic interference (EMI), the instrument may be operated only with all covers closed. Only adequately shielded signal and control cables may be used (see recommended accessories).

Connecting the Instrument to the AC Supply

The FSP is equipped with an AC voltage selection feature and will automatically adapt itself to the applied AC voltage (range: 100 to 240 V AC, 40 to 400 Hz). External voltage selection or adaptation of the fuses are not necessary. The AC power connector is located on the rear panel (see below).

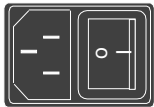

Power connector

- Connect the instrument to the AC power source using the AC power cable delivered with the instrument.

As the instrument is designed according to the regulations for safety class EN61010, it must be connected to a power outlet with earthing contact.

Switching the Instrument On/Off



Caution:

Do not power down during booting. Such a switch-off may lead to corruption of the hard disk files.

AC power switch on the rear panel

Power switch Power connector

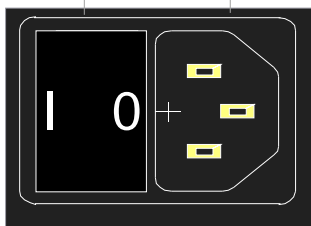

Power switch

Position I = ON

In the I position, the instrument is in standby mode or in operation, depending on the position of the ON/STANDBY key at the front of the instrument.

Note:

The AC power switch may remain ON continuously. Switching to OFF is only required when the instrument must be completely removed from the AC power source.

Position O = OFF

The 0 position implies an all-pole disconnection of the instrument from the AC power source.

ON/STANDBY switch on the front panel

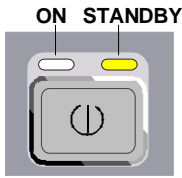

Caution:

In standby mode, the AC power voltage is present within the instrument

Standby switch

The ON/STANDBY switch activates two different operating modes indicated by coloured LEDs:

Operation ON - ON/STANDBY is depressed

The green LED (ON) is illuminated. The instrument is ready for operation. All modules within the instrument are supplied with power.

STANDBY - ON/STANDBY switch is not pressed.

The yellow LED (STANDBY) is illuminated. Only the power supply is supplied with power and the quartz oven is maintained at normal operating temperature.

Switching On the Instrument

- In order to switch on the FSP, set the power switch on the rear panel to position I.
- Set the FSP to operating mode by pressing the *ON/STANDBY* key on the front panel. The green LED must be illuminated.

Startup Menu and Booting

After switching on the instrument, a message indicating the installed BIOS version (e.g. Analyzer BIOS Rev. 1.2) appears on the screen for a few seconds.

Subsequently Windows XP is booted first and after that the instrument firmware will boot. As soon as the boot process is finished the instrument will start measuring. The settings used will be the one that was active when the instrument was previously switched off, provided no other device configuration than *FACTORY* had been selected with *STARTUP RECALL* in the *FILE* menu.

Switching Off the FSP

- Switch the ON/STANDBY key on the front panel to standby mode by pressing it once.
The yellow LED must be illuminated.

Only when removing the FSP completely from the AC power source:

- Set the power switch at the rear panel to position 0.

Power-Save Mode

Display:

The FSP offers the possibility of switching on a power-save mode for the screen display. The backlighting will be switched off if no entry is made on the front panel (key, softkey or hotkey as well as spinwheel) during the selected response time.

In order to switch on the power-save mode:

1. Call the *DISPLAY - CONFIG DISPLAY* submenu to configure the screen display:
 - Press *DISP* key
 - Press *CONFIG DISPLAY* softkey
2. Activate the save mode
 - Press *DISPLAY PWR SAVE* softkey.
The softkey is highlighted in colour, thus indicating that the power-save mode is on. At the same time the data entry for the delay time is opened.
3. Define the delay time
 - Enter the required response time in minutes and confirm the entry using the *ENTER* key.
The screen will be blanked out after the selected time period has elapsed.

A power-save mode is preset for the built-in hard disk which is automatically closed down 15 minutes after the last access.

Recalling the Most Recent Instrument Settings

The FSP stores its current instrument settings onto the hard disk every time it is switched off via the ON/STANDBY key. After each power-on, the FSP is reloaded with the operational parameters which were active just prior to the last power-off (STANDBY or AC power OFF) or were set with STARTUP RECALL (see Chapter 4 "Saving and Recalling Data Sets").

Note: *Storing the current instrument settings is not possible if the instrument is switched off using the POWER ON switch at the rear panel or when unplugging the mains cord. After power-on the instrument settings stored previously on the hard disk will be loaded in this case.*

Function Test

After turning on the AC power, the FSP will display the following message on the display screen:

```
Rohde & Schwarz GmbH & Co. KG
Analyzer BIOS      Vx.y
```

After appearance of the above message, a selftest of the controller hardware is performed. Subsequently, the Windows NT controller boots and the measurement screen will appear.

The system self-alignment is activated via *CAL* key, *CAL TOTAL* softkey. The individual results of the self-alignment (PASSED / FAILED) can be displayed in the *CAL* menu (*CAL RESULTS*).

With the aid of the built-in selftest functions (*SETUP* key, *SERVICE*, *SELFTEST* soft keys), the functional integrity of the instrument can be verified and/or defective modules can be localized.

Windows XP

**Caution:**

The drivers and programs used under Windows XP are adapted to the measuring instrument. In order to prevent the instrument functions from damage, the settings should only be modified as described below.

Existing software may only be modified using update software released by Rohde & Schwarz.

Additionally only programs authorized by Rohde & Schwarz for use on the FSP may be run on the instrument.

Do not power down during booting. *Such a switch-off may lead to corruption of the hard disk files.*

The instrument runs under the operating system Windows XP Embedded. The computer can be used to install and configure device drivers that were authorized by Rohde & Schwarz. Any further use of the computer function is only allowed under the conditions described in this operating manual.

Login

Windows XP requires a login process, during which the user is asked for identification by entering his name and password. As a factory default the instrument is configured for *Auto Login*, i.e. the login is performed automatically and in the background. The user name used for this is "instrument" and the password is also "instrument" (in small letters).

Administrator level

The NT user account used for the autologin function has administrator access rights.

Windows XP Service Packs

The Windows XP Embedded system installed on the instrument includes Service Pack 1 for XP Embedded.

Any service pack not approved by Rohde & Schwarz must not be installed since malfunctions may occur. These malfunctions could impair measurements that are correctly performed on the instrument and necessitate a repair.

The user is especially warned against using Service Packs of Windows XP Home or of the Professional Edition, since these Service Packs are not compatible with Windows XP Embedded.

Calling the Windows XP start menu

The Windows NT start menu is called using the key combination <CTRL> <ESC>. It is possible to access the required submenus from the start menu by means of the mouse or the cursor keys. In order to return to the measurement screen the button "R&S Analyzer Interface" in the Windows NT task bar can be used.

Connecting an External Keyboard

**Caution:**

Connect the keyboard only when the instrument is switched off (STANDBY). Otherwise, proper functioning cannot be ensured due to interactions with the firmware.

The FSP allows an external PC keyboard to be connected to the 6-pin PS/2 connector labelled KEYBOARD on the front panel or to the USB interface on the rear panel.



The keyboard makes it easier to enter comments, file names, etc, when measurements are performed.

If the keyboard is to be connected to the PS/2 connector, the PSP-Z2 keyboard (Order No. 1091.4100.02, English) is recommended. This keyboard includes not only the PC keyboard but also a trackball for controlling the mouse.

Keyboards and mouse devices in line with the USB standard 1.1 are suitable for connection to the USB interface.

The keyboard (except for PSP-Z2, see above) will automatically be recognized after connection. The US keyboard assignment is the default setting. Special settings such as refresh rate can be performed in the Windows XP menu START - SETTINGS - CONTROL PANEL - KEYBOARD.

Chapter 8 contains the interface description for the connectors.

Connecting a Mouse

To make Windows XP operation easier, the FSP allows a mouse to be connected to the PS/2 mouse interface or to the USB interface on the rear panel.

To make Windows XP operation easier, the FSP allows a mouse to be connected to the USB interface on the rear panel.



Microsoft and Logitech mouse types are supported.

Note. *The recommended keyboard PSP-Z2 is equipped with a trackball for mouse control. Connecting an additional mouse will cause interface conflicts and lead to malfunctions of the instrument.*

After connection the mouse is automatically recognized. Special settings such as mouse cursor speed etc, can be performed in the Windows XP menu START - SETTINGS - CONTROL PANEL - MOUSE. Chapter 8 contains the interface description for the connector.

Connecting an External Monitor

**Caution:**

The monitor may only be connected when the instrument is switched off (STANDBY). Otherwise, the monitor may be damaged.

Do not modify the screen driver (display type) and display configuration since this will severely affect instrument operation.

The instrument is equipped with a rear-panel MONITOR connector for the connection of an external monitor.

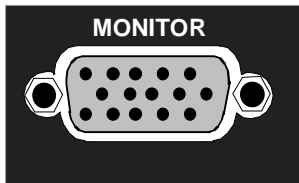

After connecting the external monitor the instrument needs to be rebooted in order to recognize the monitor. After that the measurement screen is displayed on both the external monitor and the instrument. Further settings are not necessary.

Connecting a Printer

A printer can be connected while the instrument is running.

The FSP allows two different printer configurations for printing a hardcopy to be created plus switchover between these two configurations. The *DEVICES* table in the *HCOPY* menu shows the available selection of installed printers (see section 4.4 "Documentation of Measurement Results").

The interfaces for connecting printers are on the rear panel:

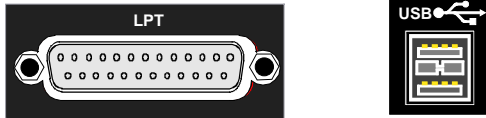

Chapter 8 contains the interface description for the connectors.

Selecting a Printer

Before a hardcopy can be printed, the printer has to be selected from the "*HCOPY*" menu.

In the following example, an HP DeskJet 660C printer that was preinstalled for LPT1 is selected as *DEVICE2* for hardcopies of the screen content.

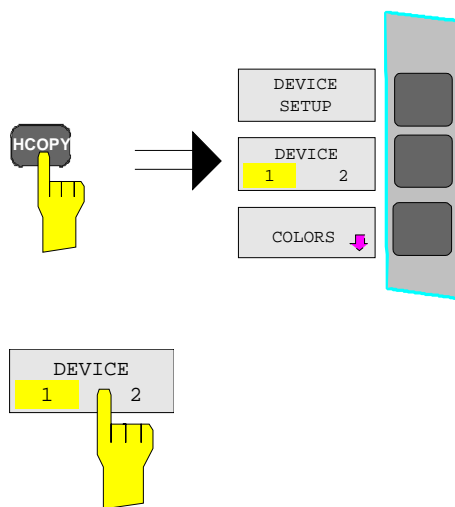

-
- Press the *HCOPY* key.
- The *HCOPY* menu will open.

-
- Press the *DEVICE 1/2* softkey.
- Device 2 will become the active output unit.

Note:
If the printer is to be operated as device 1, this step can be omitted.

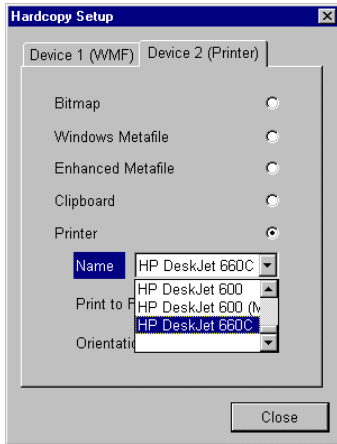
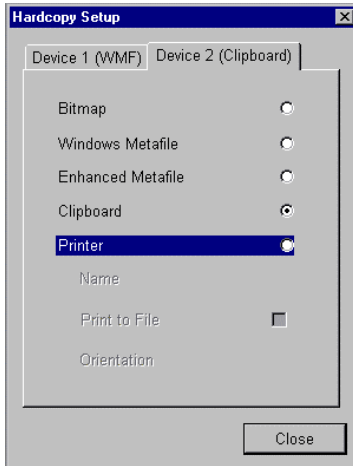
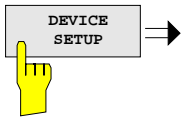

- Press the *DEVICE SETUP* softkey.

The *HARDCOPY SETUP* table opens and displays the selection of output formats. The current selection "*Clipboard*" is highlighted and marked with a dot in the option button.

- Use the cursor key to move the selection bar to "*Printer*" and press *ENTER*.

Windows for selecting a printer (Name), printing to file (Print to File) and selecting printout orientation (Orientation) are displayed.

- Use the cursor key to set the selection bar to "*Name*" and press *ENTER*.

The list of available printer types appears.

- Use the cursor key / or the spinwheel to move the selection bar to the "HP DeskJet 660C" printer and press *ENTER*.

The list closes and the selected printer appears in the "Name" field.

Note:

If the desired printer is not available in the selection list, its driver must first be installed.

For further information, see sections "Installation of Plug&Play Printers", "Installation of Non-Plug&Play Printers" and "Installation of Network Printers".

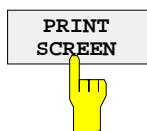
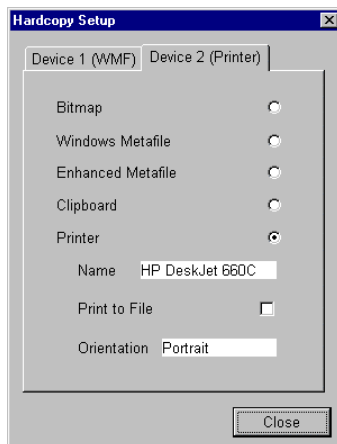
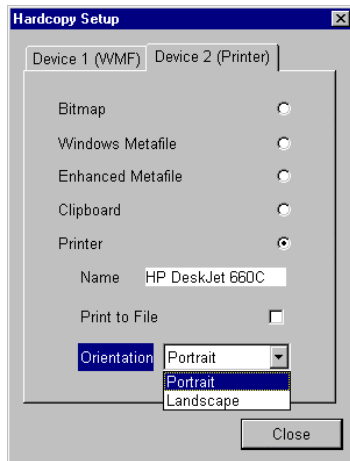
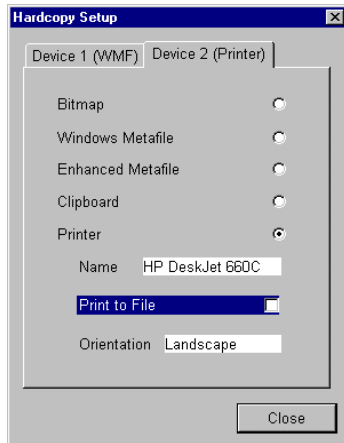



- Press the cursor key  or turn the spinwheel until the "Close" button is reached.

Further settings can still be made:

"Print to File" redirects printing to a file. In this case, the system prompts you for a file name when printing is started.

- The selection is activated by pressing *ENTER* or the spinwheel.

"Orientation" is used to switch between portrait and landscape format.

- To change the selection, open the list by pressing *ENTER* and select the desired orientation with the cursor key  / . To close the list, press *ENTER* again.

The "Close" button is used to complete the setup.

- Press *ENTER* as soon as the "Close" button is available.

The dialog closes. Printing will now be performed according to the selected settings.

Start printing

- Press the *PRINT SCREEN* softkey.

A hardcopy of the screen contents will be printed.

The factory setting for DEVICE 2 is "Clipboard". In this case, the printout will be copied to the Windows XP clipboard which is supported by most Windows applications. The contents of the clipboard can be pasted directly into a document via EDIT - PASTE.

Table 1-1 Factory settings for *DEVICE 1* and *DEVICE 2* in the *HCOPY* menu shows the factory settings for the two output devices.

Table 1-1 Factory settings for *DEVICE 1* and *DEVICE 2* in the *HCOPY* menu

Setting	Selection in configuration table	Setting for <i>DEVICE 1</i>	Setting for <i>DEVICE 2</i>
Output device	DEVICE	WINDOWS METAFILE	CLIPBOARD
Output	PRINT TO FILE	YES	---
Orientation	ORIENTATION	---	---

Installation of Plug&Play Printers

The installation of Plug&Play printers under Windows XP is quite simple:

After the printer is connected and switched on, Windows XP automatically recognizes it and installs its driver, provided the driver is included in the XP installation.

If the XP printer driver is not found, Windows XP prompts you to enter the path for the corresponding installation files. In addition to pre-installed drivers, a number of other printer drivers can be found in directory D:\I386.

Note: *When installing new printer drivers, you will be prompted to indicate the path of the new driver. This path may be on a disk in drive A. Alternatively, the driver can be loaded via a memory stick or USB CD-ROM drive (see section "Connection of USB Devices").*

Installation of Non-Plug&Play Printers

Note: *The dialogs below can be controlled either from the front panel or via the mouse and keyboard (see sections "Connecting a Mouse" and "Connecting a Keyboard"). Mouse and PC keyboard are absolutely essential for configuring network printers.*

A new printer is installed with the *INSTALL PRINTER* softkey in the *HCOPY* menu.

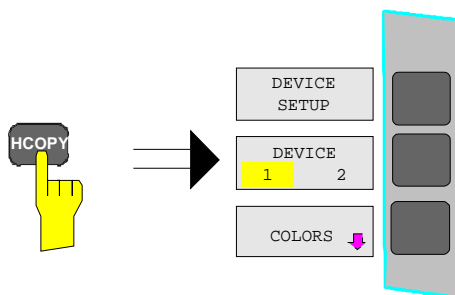

- Press the *HCOPY* key.
- The *HCOPY* menu will open.

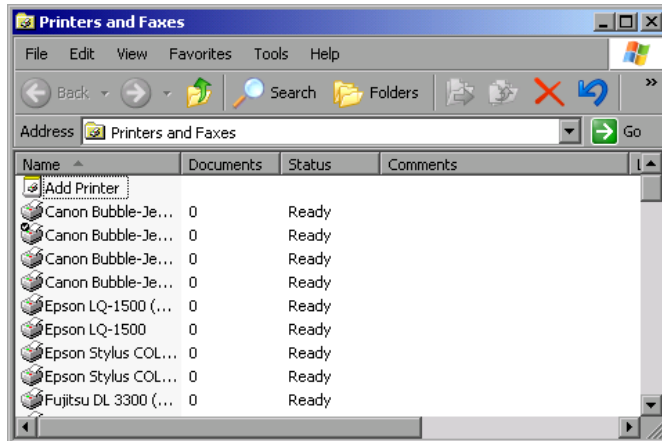
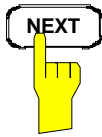

➤ Press the **NEXT** key to open the side menu.

➤ Press **INSTALL PRINTER** to open the *Printers and Faxes* dialog window.

➤ Select **Add Printer** in the list using the spinwheel.

➤ Highlight the selected item with **CURSOR RIGHT** and press **ENTER** or the spinwheel to confirm the selection.

The *Add Printer Wizard* is displayed.

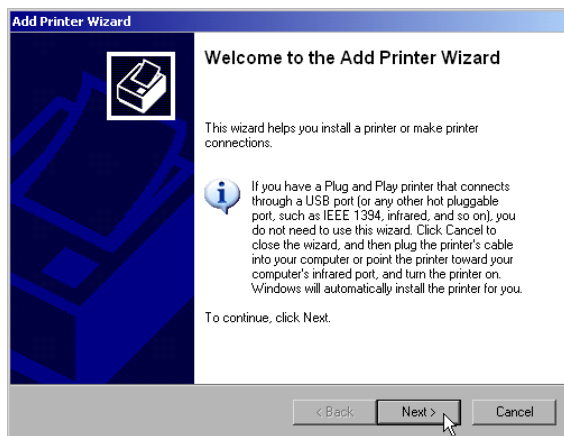

➤ Select **NEXT** with the spinwheel and press the spinwheel for confirmation.

Local or Network Printer can be selected.

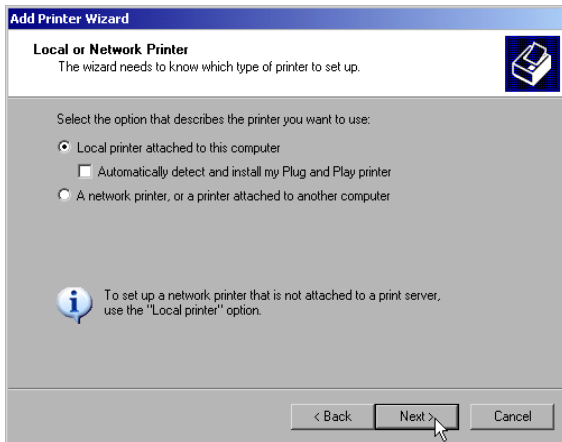

- To install a local printer, select *Local printer attached to this computer* with the spinwheel. Press the spinwheel for confirmation and continue with the "Local Printer" section.
- To install a network printer, select *A network printer or a printer attached to another computer*. Press the spinwheel for confirmation and continue with the "Network Printer" section.

Local Printer

In the following example, a Star LC24 printer is connected to the LPT1 interface and configured as *DEVICE2* for hardcopies of screen contents. The Add Printer Wizard has already been opened as described in the section "Starting the Add Printer Wizard" .

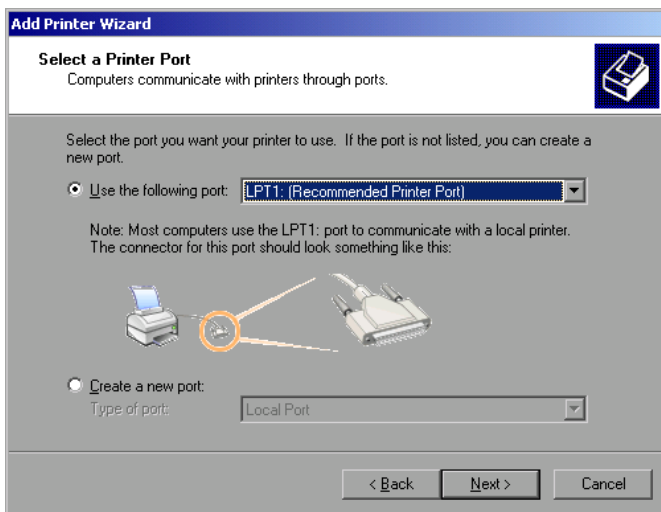

- To select the USB interface, open the list of ports by clicking the spinwheel. Select the printer port with spinwheel/arrow keys and confirm by pressing the spinwheel. The selection list is closed again.
 - To select the LPT connector, the selection list need not be opened.
 - Place the cursor on the *Next* button and confirm by pressing the spinwheel.
- The "Install Printer Software" dialog is opened.

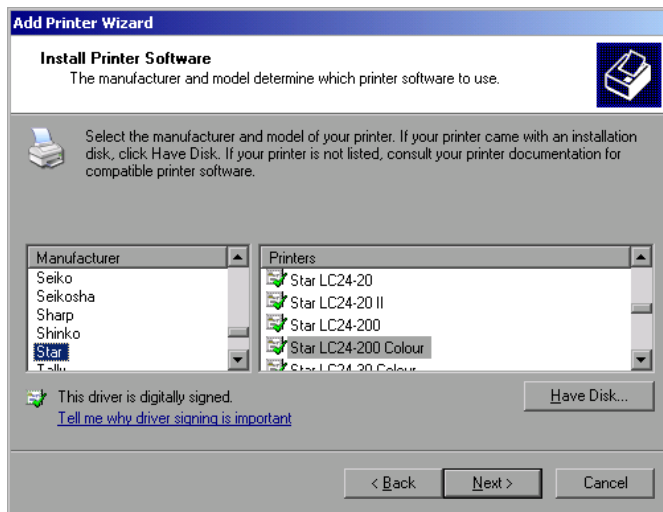

- Select the desired manufacturer ("Star") in the Manufacturer table using the up / down keys.

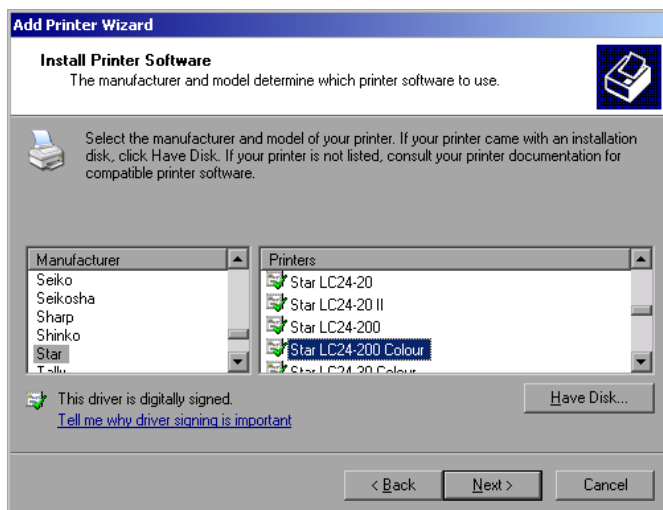

- Go to the *Printers* list with the spinwheel.
- Select the desired printer type (Star LC24-200 Colour) using the up / down keys and confirm with *ENTER*.

Note:

If the desired printer type is not in the list, the respective driver is not installed yet. In this case click the HAVE DISK button with the mouse key. You will be prompted to insert a disk with the corresponding printer driver. Press OK and select the desired printer driver.

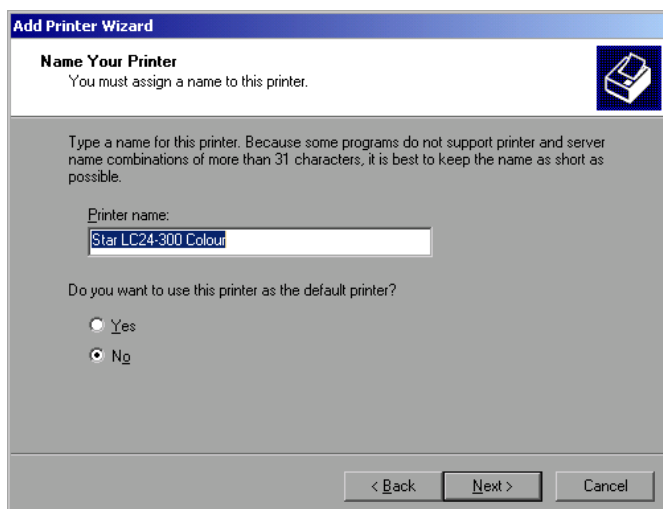

- The printer name can be changed as required in the *Printer name* entry field (max. 60 characters). A PC keyboard is required in this case.
- Use the spinwheel to select *Yes or No* for the default printer.
- Choose the desired status with the up /down keys.
- Confirm with *ENTER*.

The *Printer Sharing* dialog is opened.

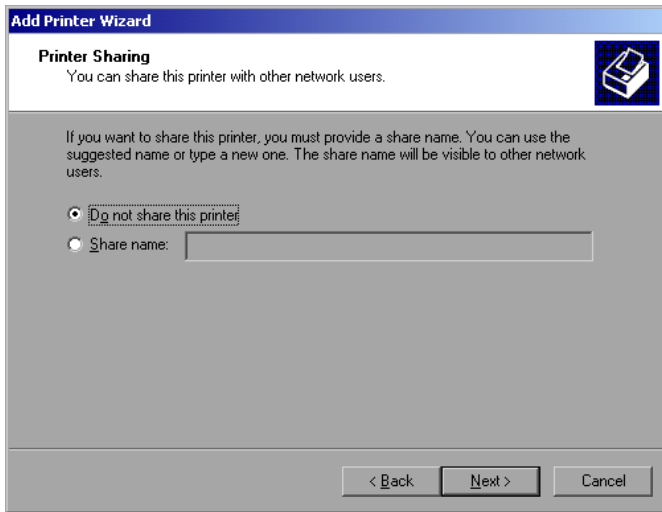

- Exit the dialog with *ENTER*.
The *Print Test Page* dialog is opened.

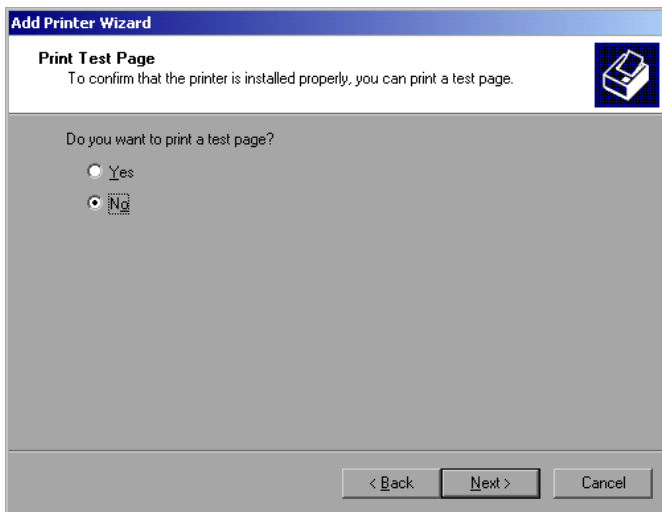

- Exit the dialog with *ENTER*.
The *Completing the Add Printer Wizard* dialog is opened.

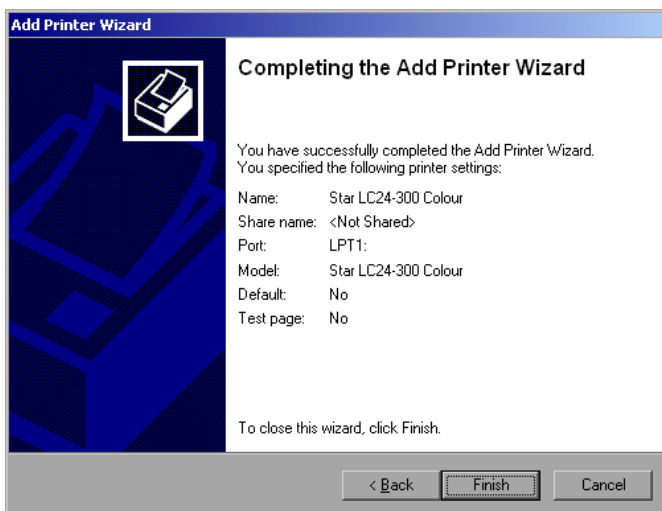

- Check the displayed settings and exit the dialog with *ENTER*.
The printer is installed. If Windows finds the required driver files, the installation is completed without any further queries.
If Windows cannot find the required driver files, a dialog is opened where the path for the files can be entered.

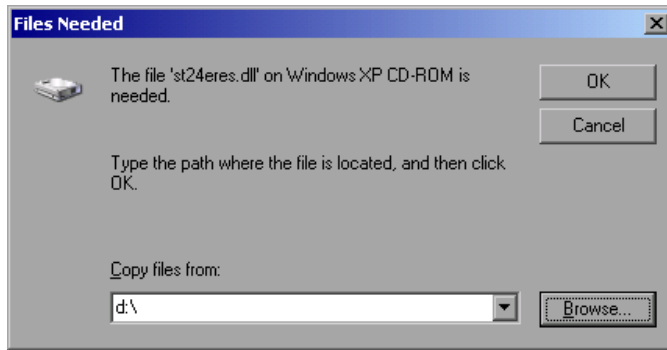

- Select the *Browse* button with the spinwheel and confirm with by pressing the spinwheel.

The *Locate File* dialog is opened.

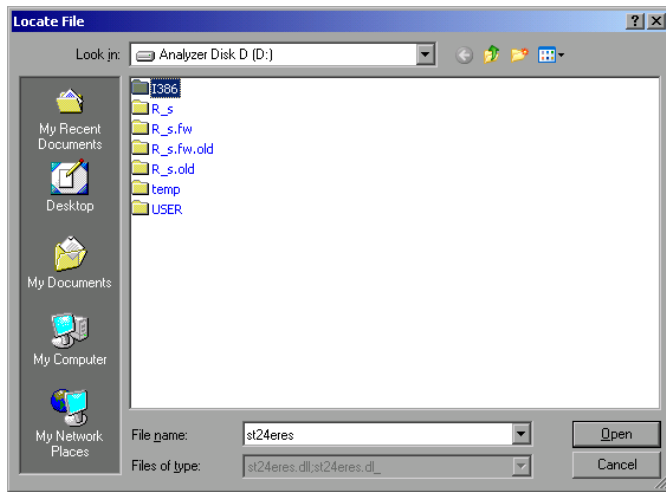

- Turn the spinwheel to select the directory and path D:\I386 and press it to confirm the selection.

If the selected item is not printed on a blue background, it must be marked with the cursor up / down keys before it can be activated by pressing the spinwheel.

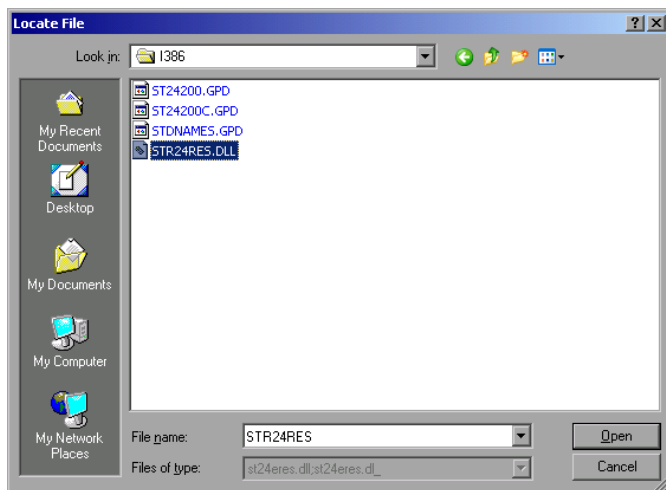

- Select the driver file with the spinwheel and confirm by pressing the spinwheel.

The file is included in the *Files Needed* dialog.

Note:

If the desired file is not in the D:\I386 directory, a disk with the driver file is needed. In this case, exit the dialog with ESC and repeat the selection starting from the "Files needed" dialog.

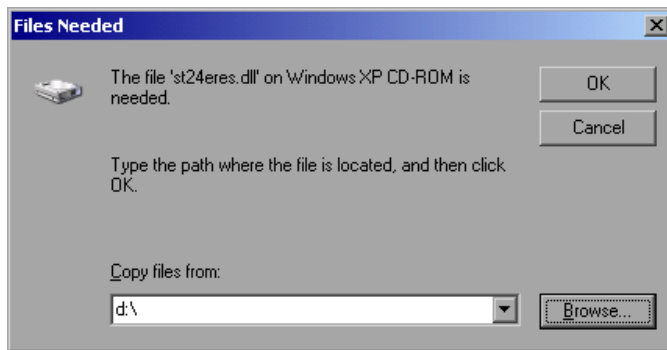

- Select the *OK* button with the spinwheel and press the spinwheel to confirm.
The installation is completed.

Finally, the instrument must be configured for printout with this printer using the softkeys *DEVICE SETUP* and *DEVICE 1/2* in the hardcopy main menu (see section "Selecting a printer").

Configuring a Network Printer (with Option FSP-B16 only)

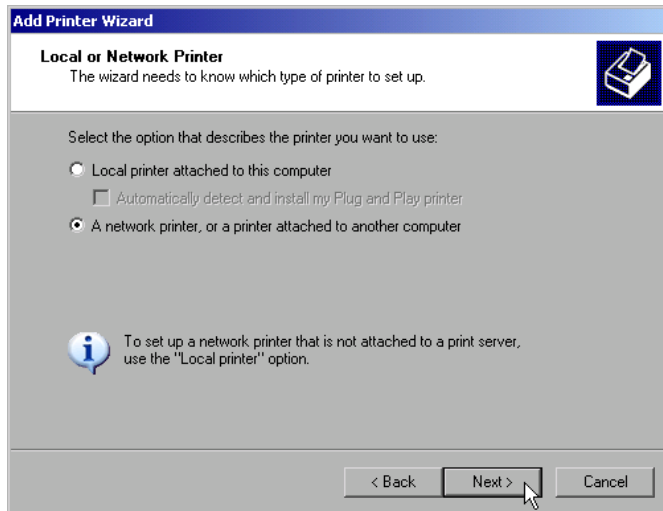

- To select a network printer, click the option "A network printer or a printer attached to another computer".

Continue with *Next*.

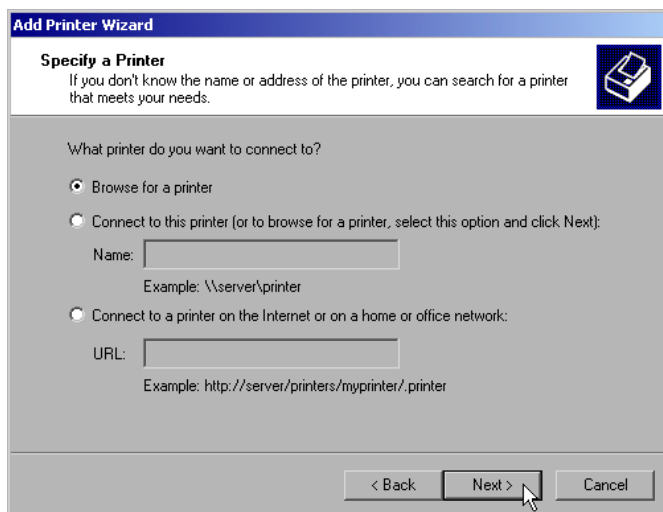

- Click *Browse for a printer* and then *Next*. A list of selectable printers is displayed.

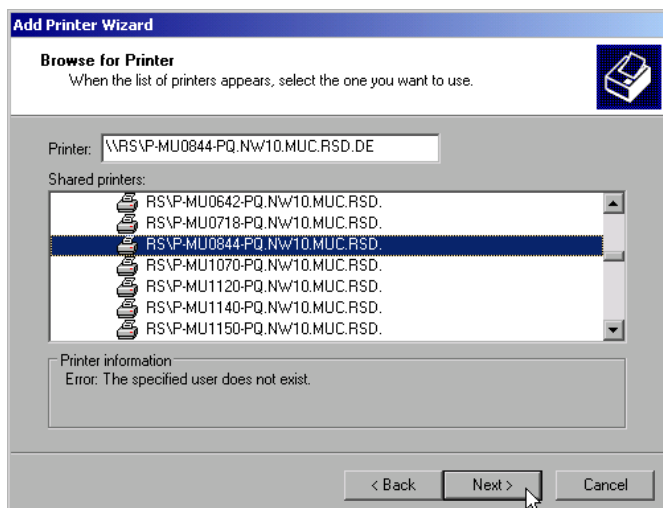

- Mark the desired printer and select it with *OK*.

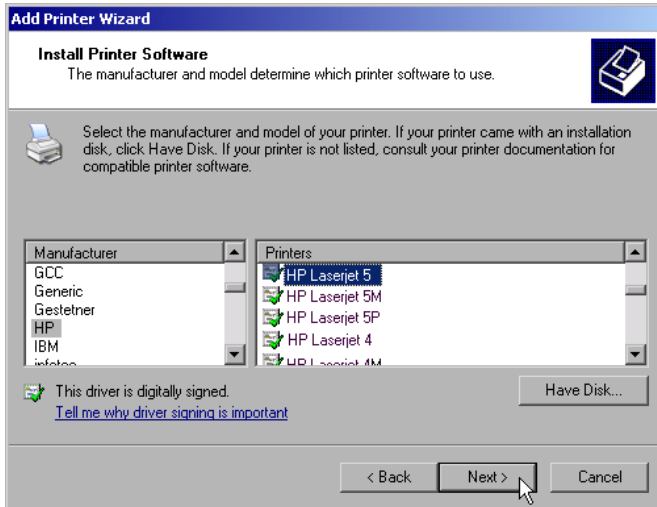

- Confirm the subsequent prompt to install a suitable printer driver with "OK". The list of available printer drivers is displayed. The manufacturers are listed in the left-hand table, the available printer drivers in the right-hand table.
- Select the manufacturer from the *Manufacturers* table and then the printer driver from the *Printers* table.

Note:

If the desired type of output device is not shown in the list, the driver has not yet been installed. In this case, click the "HAVE DISK" button. You will be prompted to insert a disk with the corresponding printer driver. Insert the disk, select "OK" and then choose the desired printer driver.

- Click Next.

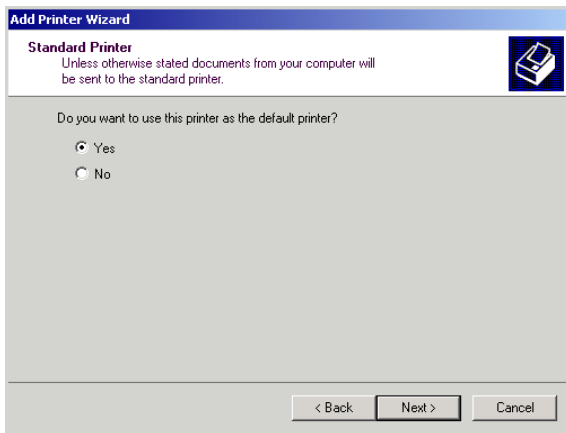

If one or more printers have already been installed, this window queries whether the printer last installed is to be used as the default printer for the Windows XP applications. The default selection is *No*.

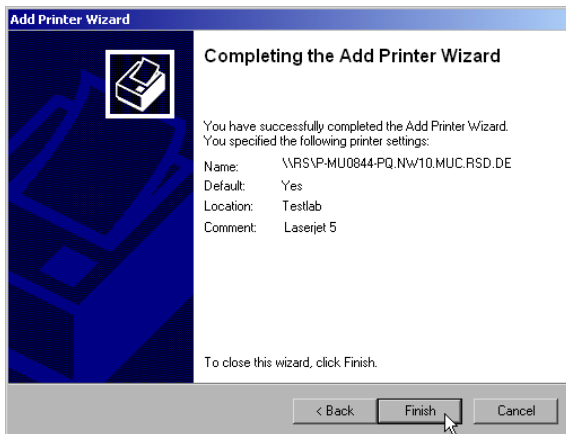

- Start the printer driver installation with *Finish*.

Finally, the instrument has to be configured for printout with this printer using the softkeys *DEVICE SETUP* and *DEVICE 1/2* in the hardcopy menu (see section "Selection of a Printer").

Connection of USB Devices

Up to two USB devices can be directly connected to the analyzer via the USB interface on the rear of the FSP. This number can be increased as required by interconnecting USB hubs.

Owing to the wide variety of available USB devices, the FSP can be expanded with almost no limitations. The following list shows a selection of USB devices suitable for the FSP:

- Power Sensor R&S NRP-Z11 or R&S NRP-Z21 (Adapter Cable R&S NRP-Z4 required)
- Pendrive (memory stick) for easy data transfer from/to the PC (e.g. firmware updates)
- CD-ROM drive for easy installation of firmware applications
- PC keyboard for entering comments, file names, etc
- Mouse for easy operation of Windows dialogs
- Printer for documentation of measurement results
- Modem for remote control of the FSP over great distances

The installation of USB devices is quite simple under Windows XP since all USB devices are Plug&Play. Apart from the keyboard and the mouse, all USB devices can be connected to or disconnected from the FSP while the instrument is running.

After the instrument is connected to the USB interface, Windows XP automatically searches for a suitable device driver.

If Windows XP does not find a suitable driver, you will be prompted to specify a directory where the driver software can be found. If the driver software is on a CD, a USB CD-ROM should first be connected to drive to the FSP.

As soon as the connection between the FSP and the USB device is interrupted, Windows XP will again recognize the modified hardware configuration and will deactivate the corresponding device driver.

Example:

Connecting a pendrive (memory stick) to the FSP:

1. After the pendrive is connected to the USB interface, Windows XP will recognize the newly connected hardware:

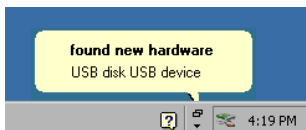

2. Windows XP installs the corresponding driver.
After successful installation, XP signals that the unit is ready for operation:

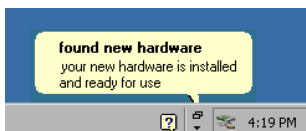

3. The pendrive is now available as a new drive and is displayed in Windows Explorer:

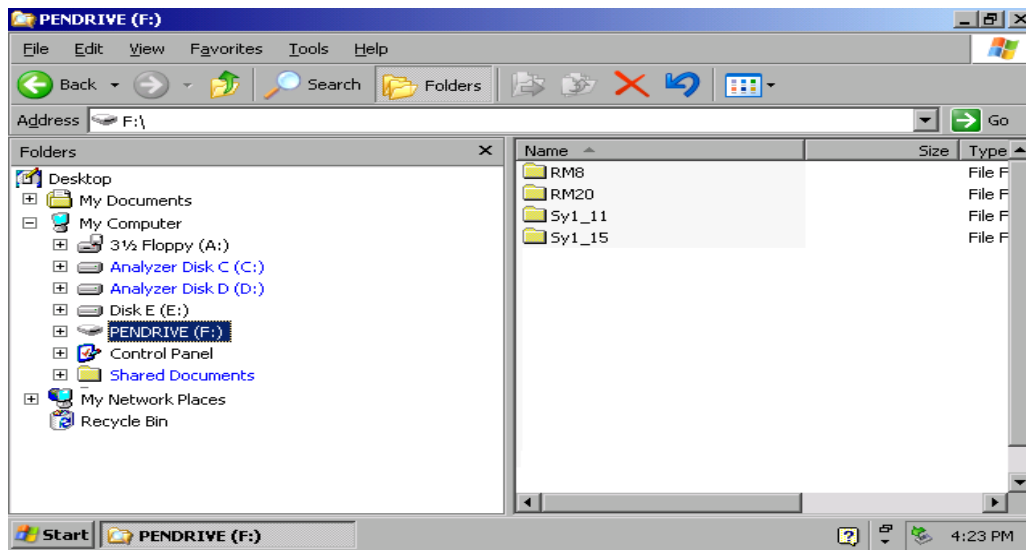

The pendrive can be used as a normal drive to load or save files.

4. If the pendrive is no longer required or if files are to be transferred to another computer, the pendrive is simply disconnected. Windows XP will then deactivate the driver. If the corresponding drive is still selected in Explorer, an error message will be displayed indicating that the drive is no longer available.

Installing Windows XP Software

Authorized Windows XP Software for the Instrument

The driver software and the system settings of Windows XP are adapted to the measurement functions of the instrument. Correct operation of the instrument can therefore be guaranteed only if the software and hardware used are authorized or supplied by Rohde & Schwarz.

The following program packages have been successfully tested for compatibility with the instrument's software:

- FS-K3 – software for measuring noise factor and gain
- FS-K4 – software for measuring phase noise
- R&S Power Viewer
(virtual power sensor for displaying the results of Power Sensors NRP-Z11 and -Z21)
- Windows XP remote desktop
- FileShredder – for deleting files from the hard disk
- Symantec Norton AntiVirus – software for protection against viruses

The use of other software or hardware may cause failures in the functions of the FSP. A current list of the software authorized for use on the FSP can be obtained from your nearest Rohde & Schwarz agency (see list of addresses).

Contents - Chapter 2 "Getting Started"

2 Getting Started.....	2.1
Level and Frequency Measurements.....	2.1
Measurement Example 1 – Measuring Frequency and Level using Markers	2.1
Measurement Example 2 – Measuring Frequency with the Frequency Counter.....	2.3
Measurement of Harmonics.....	2.5
Measuring Harmonics with Frequency Sweeps.....	2.7
Measurement Example – Measuring the distance between fundamental wave and the 2 nd and 3 rd harmonics of the internal reference signal	2.7
High-Sensitivity Harmonics Measurements.....	2.10
Measurement Example	2.10
Measuring the Spectra of complex Signals	2.13
Separating Signals by Selecting an Appropriate Resolution Bandwidth.....	2.13
Measurement Example - Resolving two signals with a level of –30 dBm each and a frequency difference of 30 kHz.....	2.14
Intermodulation Measurements	2.17
Measurement Example – Measuring the FSP's intrinsic intermodulation distance.....	2.19
Measuring Signals in the Vicinity of Noise	2.23
Measurement example – Measuring the level of the internal reference generator at low S/N ratios	2.25
Noise Measurements.....	2.28
Measuring noise power density	2.28
Measurement example – Measuring the intrinsic noise power density of the FSP at 1 GHz and calculating the FSP's noise figure.	2.28
Measurement of Noise Power within a Transmission Channel	2.31
Measurement Example – Measuring the intrinsic noise of the FSP at 1 GHz in a 1.23 MHz channel bandwidth with the channel power function.....	2.31
Measuring Phase Noise.....	2.35
Measurement Example - Measuring the phase noise of a signal generator at a carrier offset of 10 kHz.	2.35
Measurements on Modulated Signals	2.37
Measurements on AM signals	2.37
Measurement Example 1 – Displaying the AF of an AM signal in the time domain.	2.37
Measurement Example 2 -	
Measuring the modulation depth of an AM carrier in the frequency domain.....	2.39
Measurements on FM Signals.....	2.40
Measurement Example - Displaying the AF of an FM carrier	2.40
Measuring Channel Power and Adjacent Channel Power.....	2.43
Measurement Example 1 - ACPR measurement on an IS95 CDMA Signal.....	2.44
Measurement Example 2 – Measuring the adjacent channel power of an IS136 TDMA signal	2.48
Measurement Example 3 - Measuring the Modulation Spectrum in Burst Mode with the Gated Sweep Function	2.51
Measurement Example 4 - Measuring the Transient Spectrum in Burst Mode with the Fast ACP function	2.53
Measurement Example 5 - Measuring adjacent channel power of a W-CDMA uplink signal	2.55

Amplitude distribution measurements	2.58
Measurement Example – Measuring the APD and CCDF of white noise generated by the FSP.....	2.58
Time Domain Measurements	2.61
Power measurements.....	2.61
Measurement Example – Measuring the power of a GSM burst during the switch-on phase	2.61
Power Ramping Measurement for Burst Signals.....	2.63
Measurement Example – Measurements on GSM burst edges using a high time resolution.....	2.63
Measuring the S/N Ratio of Burst Signals	2.65
Measurement Example - S/N ratio of a GSM signal	2.65

2 Getting Started

Chapter 2 explains how to operate the FSP using typical measurements as examples. Chapter 3 describes the basic operating steps such as selecting the menus and setting parameters, and explains the screen structure and displayed function indicators. Chapter 4 describes all the menus and FSP functions.

All of the following examples are based on the standard settings of the analyzer. These are set with the *PRESET* key. A complete listing of the standard settings can be found in chapter 4, section "Preset settings of the FSP – *PRESET* key".

Level and Frequency Measurements

Measuring the frequency and level of a signal is one of the most common purposes for the use of a spectrum analyzer. For unknown signals, the spectrum analyzer default settings (PRESET) are a good starting point for the measurement.

If signal levels at the RF input are expected to be above 30 dBm (= 1 W), a power attenuator must be connected to the RF input of the spectrum analyzer. Please note that the total power of all applied signals must be taken into account concerning this limit. If a power attenuator is not used, signal levels above 30 dBm can destroy the RF attenuator or the input mixer.

Measurement Example 1 – Measuring Frequency and Level using Markers

It is easy to measure the level and frequency of a sinewave carrier with the marker function. At the marker position, the FSP indicates the signal's amplitude and frequency. The accuracy of the frequency measurement is determined by the FSP reference frequency, the resolution of the marker frequency display and the resolution of the screen.

In the example, the frequency of the 128-MHz internal reference generator is displayed using the marker.

- 1. Set the spectrum analyzer to its default settings.**
 - Press the *PRESET* key.
- 2. Connect the test signal to the RF INPUT on the instrument front panel.**
- 3. Switch on the internal reference generator.**
 - Press the *SETUP* key.
The *SETUP* menu opens.
 - Press the *SERVICE* softkey.
The *SETUP - SERVICE* menu opens.
 - Press the *INPUT CAL* softkey.
The internal reference generator is turned on.
The FSP's RF input is turned off.
- 4. Set the center frequency to 128 MHz.**
 - Press the *FREQ* key.
 - The entry field for the center frequency is displayed on the screen.
 - Enter *128* from the numeric keypad and terminate the entry with the *MHz* key.
- 5. Reduce the measurement frequency range (SPAN) to 1 MHz.**

- Press the *SPAN* key.
- Enter *1* from the numeric keypad and terminate the entry with the *MHz* key.

Note: *If the SPAN is changed, the resolution bandwidth (RES BW), the video bandwidth (VIDEO BW) and the sweep time (SWEEP TIME) are also set to new values because they are defined as coupled functions in the standard PRESET settings.*

6. Measure the level and frequency using the marker and read off the results from the screen.

- Press the *MKR* key.
The marker is switched on and automatically jumps to the trace peak.

Note: *When a marker is switched on for the first time, it automatically performs the PEAK SEARCH function (as in this example).
If a marker is already active, the PEAK softkey in the MKR-> menu must be pressed in order to set the currently active marker onto the displayed signal maximum.*

The level and frequency indicated by the marker are displayed in the marker info field at the upper edge of the screen. These are the measurement results.

```
Marker 1 [T1]
      -30.00 dBm
      128.00000000 MHz
```

The info-field header indicates the number of the marker (*MARKER 1*) and the number of the trace on which the marker is positioned (*[T1]* = Trace 1).

Increasing the Frequency Resolution During a Frequency Measurement with a Marker

The frequency resolution of the marker is determined by the pixel resolution of the trace. The FSP uses 501 pixels for a trace, i.e. at a frequency span of 1 MHz each pixel corresponds to a frequency range of approx. 2 kHz. This gives a maximum error of 1 kHz.

To increase the pixel resolution of the trace, the frequency span has to be reduced.

7. Reduce the frequency span to 10 kHz.

- Press the *SPAN* key.
- Enter *10* from the numeric keypad and terminate the entry with the *kHz* key.

Note: *If the SPAN is changed, the resolution bandwidth (RES BW), the video bandwidth (VIDEO BW) and the sweep time (SWEEP TIME) are also set to new values because they are defined as coupled functions in the standard PRESET settings.*

The internal reference signal is measured with a span of 10 kHz. The pixel resolution of the trace is now approx. 20 Hz (10 kHz span / 501 pixel), i.e. the accuracy of the marker frequency display is increased to approx. 10 Hz.

8. Switch on the RF input again for normal operation of the analyzer.

- Press the *PRESET* key or press the *SETUP* key and the *SERVICE* softkey.
- Press the *INPUT RF* softkey.
The internal signal path of the FSP is switched back to the RF input in order to resume normal operation.

Measurement Example 2 – Measuring Frequency with the Frequency Counter

With the internal frequency counter, frequencies can be measured more accurately than with the marker. The frequency sweep is stopped at the marker position and the FSP measures the frequency of the corresponding signal. If an analog bandwidth (≥ 300 kHz) is used, the frequency is measured by counting the zero-crossings of the last IF. With digital resolution bandwidths (10 Hz to 100 kHz), the frequency measurement is performed in the IQ baseband by a special approximation algorithm.

The resolution range for the frequency measurement is 0.1 Hz to 10 kHz. At bandwidths ≥ 300 kHz, the time required for the FSP to perform the frequency measurement is dependent on the selected counter resolution ($1/(\text{frequency resolution in Hz})$). The digital frequency approximation takes about 30 ms to perform a frequency measurement irrespective of the selected resolution.

The frequency measurement accuracy is determined by the reference frequency of the FSP and the selected counter resolution.

In the example, the frequency of the 128-MHz internal reference generator is displayed with the marker.

1. Set the spectrum analyzer to the default settings.

- Press the *PRESET* key.
The FSP is in its default state.

2. Switch on internal reference generator

- Press the *SETUP* key.
- Press the softkeys *SERVICE - INPUT CAL*.
The internal 128 MHz reference generator is now on. The FSP's RF input is turned off.

3. Set the center frequency and the frequency span

- Press the *FREQ* key and enter *128 MHz*.
The FSP center frequency is set to 128 MHz.
- Press the *SPAN* softkey and enter *1 MHz*.
The FSP frequency span is set to 1 MHz.

4. Switch on the marker

- Press the *MKR* key.
The marker is switched on and set to the signal maximum. The level and the frequency at the marker are displayed in the marker-info field.

5. Switch on the frequency counter.

- Press the *SIGNAL COUNT* softkey in the marker menu.
The frequency count is displayed in the marker field at the top of the screen along with the set resolution (1 kHz is the default setting).
The sweep stops at the marker position and the FSP measures the frequency of the corresponding signal. The frequency is output in the marker info field. To distinguish the signal count result from the normal marker frequency display, the marker is labeled with CNT.

6. Set the resolution of the frequency counter to 1 Hz.

- Press the *NEXT* key.
- Press the *CNT RESOL 1 Hz* softkey.

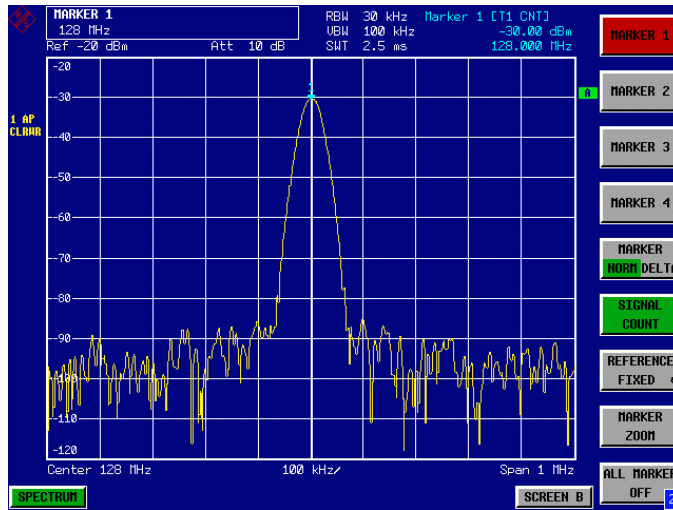

Fig. 2-1 Frequency measurement with a frequency counter

Note: The frequency measurement with the integral frequency counter only gives correct results for RF sinewaves or discrete spectral lines. To meet the specified measurement accuracy, the marker should be more than 25 dB above noise.

7. Switch on the RF input again for normal operation of the analyzer.

- Press the *PRESET* key or press the *SETUP* key and the *SERVICE* softkey.
- Press the *INPUT RF* softkey.
The internal signal path of the FSP is switched back to the RF input in order to resume normal operation.

Hint: For bandwidths between 300 kHz and 10 MHz, the FSP uses a frequency counter at an IF of 20.4 MHz. The time for measuring the frequency is, therefore, inversely proportional to the selected resolution, i.e. at a resolution of 1 Hz a gate time of 1 second is required for the counter. For digital bandwidths below 300 kHz, the frequency is measured in the baseband by digital frequency approximation. The time required for measuring the frequency is approx. 30 ms irrespective of the selected resolution. When measuring the frequency of a sinewave carrier at a high resolution it is, therefore, best to set a resolution bandwidth of 100 kHz or less. The measurement time will then be reduced to a minimum.

Measurement of Harmonics

Measuring the harmonics of a signal is a frequent problem which can be solved best by means of a spectrum analyzer. In general, every signal contains harmonics which are larger than others. Harmonics are particularly critical regarding high-power transmitters such as transceivers because large harmonics can interfere with other radio services.

Harmonics are produced by nonlinear characteristics. They can often be reduced by lowpass filters. Since the spectrum analyzer has a nonlinear characteristic, e.g. in its first mixer, measures must be taken to ensure that harmonics produced in the analyzer do not cause spurious results. If necessary, the fundamental wave must be selectively attenuated with respect to the other harmonics with a highpass filter.

When harmonics are being measured, the obtainable dynamic range depends on the K2 intercept of the spectrum analyzer. The K2 intercept is the virtual input level at the RF input mixer at which the level of the 2nd harmonic becomes equal to the level of the fundamental wave. In practice, however, applying a level of this magnitude would damage the mixer. Nevertheless the available dynamic range for measuring the harmonic distance of a DUT can be calculated relatively easily using the second harmonic intercept.

As shown in Fig. 2-2, the level of the 2nd harmonic is reduced by 20 dB if the level of the fundamental wave is reduced by 10 dB.

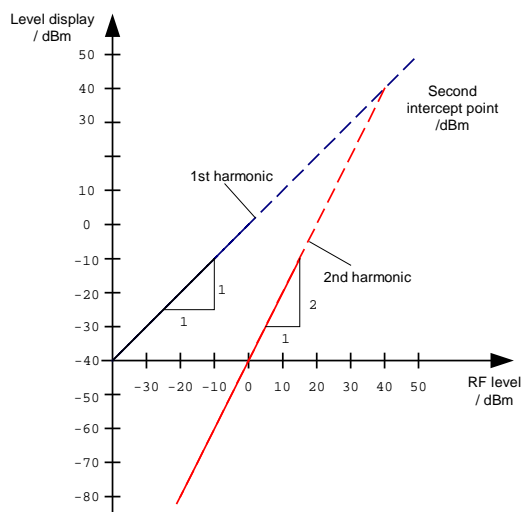

Fig. 2-2 Extrapolation of the 1st and 2nd harmonics to the second harmonic intercept at 40 dBm

The following formula for the obtainable harmonic distortion d_2 in dB is derived from the straight-line equations and the given intercept point:

$$d_2 = \text{S.H.I} - P_1 \quad (1)$$

d_2 = harmonic distortion
 P_1 = mixer level/dBm
 S.H.I. = second harmonic intercept

Note: The mixer level is the applied RF level minus the set RF attenuation.

The formula for the internally generated level P_1 at the 2nd harmonic in dBm is:

$$P_1 = 2 \cdot P_1 - \text{S.H.I.} \quad (2)$$

The lower measurement limit for the harmonic is the noise floor of the spectrum analyzer. The harmonic of the measured DUT should – if sufficiently averaged by means of a video filter – be at least 4 dB above the noise floor so that the measurement error due to the input noise is less than 1 dB.

The following rules for measuring high harmonic ratios can be derived:

1. Select the smallest possible IF bandwidth for a minimal noise floor.
2. Select an RF attenuation which is high enough to just measure the harmonic ratio.

The maximum harmonic distortion is obtained if the level of the harmonic equals the intrinsic noise level of the receiver. The level applied to the mixer, according to (2), is:

$$P_i = \frac{P_{noise} / dBm + IP2}{2}$$

At a resolution bandwidth of 10 Hz (noise level -143 dBm, S.H.I. = 40 dBm), this level is -51.5 dBm. According to (1) a maximum measurable harmonic distortion of 91.5 dB minus a minimum S/N ratio of 4 dB is obtained.

Hint:	If the harmonic emerges from noise sufficiently (approx. >15 dB), it is easy to check (by changing the RF attenuation) whether the harmonics originate from the DUT or are generated internally by the spectrum analyzer. If a harmonic originates from the DUT, its level remains constant if the RF attenuation is increased by 10 dB. Only the displayed noise is increased by 10 dB due to the additional attenuation. If the harmonic is exclusively generated by the spectrum analyzer, the level of the harmonic is reduced by 20 dB or is lost in noise. If both – the DUT and the spectrum analyzer – contribute to the harmonic, the reduction in the harmonic level is correspondingly smaller.
--------------	------------------------------------------------------------------------------------------------------------------------------------------------------------------------------------------------------------------------------------------------------------------------------------------------------------------------------------------------------------------------------------------------------------------------------------------------------------------------------------------------------------------------------------------------------------------------------------------------------------------------------------------------------------------------------------------------------------

Measuring Harmonics with Frequency Sweeps

There are advantages in performing harmonic measurements with a single frequency sweep, provided that the harmonic distance is in a way that a resolution bandwidth can be selected which is wide enough to give an acceptably short sweep time.

Measurement Example – Measuring the distance between fundamental wave and the 2nd and 3rd harmonics of the internal reference signal

1. Set the spectrum analyzer to the default settings.

- Press the *PRESET* key.
The FSP is in its default state.

2. Switch on the internal reference generator

- Press the *SETUP* key.
Press the softkeys *SERVICE - INPUT CAL*.
The internal 128 MHz reference generator is now on. The FSP's RF input is switched off.

3. Set the start frequency to 100 MHz and the stop frequency to 400 MHz

- Press the *FREQ* key.
- Press the *START* softkey and enter 100 MHz.
- Press the *STOP* softkey and enter 400 MHz.
The FSP displays the fundamental and the 2nd and 3rd harmonics of the input signal.

4. Set the RF attenuation to 0 dB to obtain maximum sensitivity

- Press the *AMPT* key.
- Press the *RF ATTEN MANUAL* softkey and enter 0 dB.

5. Reduce the video bandwidth to average (suppress) noise.

- Press the *BW* key.
- Press the *COUPLING RATIO* softkey.
- Select *RBW/VBW NOISE [10]* using the cursor keys.

The video bandwidth (VBW) will now always be set to a value which is 10 times smaller than the resolution bandwidth (RBW).

6. Switch on the marker

- Press the *MKR* key.
Marker 1 is switched on and is positioned on the signal maximum (fundamental wave at 128 MHz). The level and the frequency of the marker are displayed in the marker info field.

7. Switch on the delta marker and measure the harmonic distance

- Press the *MARKER 2* softkey in the marker menu.
Marker 2 is activated as a delta marker (Delta 2 [T1]). It appears automatically on the largest harmonic of the signal. The frequency and level, related to marker 1, are indicated in the marker field at the top of the screen.
- Press the *MARKER 3* softkey in the marker menu.
Marker 3 is activated as a delta marker (Delta 3 [T1]). It appears automatically on the next largest harmonic of the signal. The frequency and level, related to marker 1 on the fundamental wave, are displayed in the marker info field at the top of the screen (see Fig. 2-3).

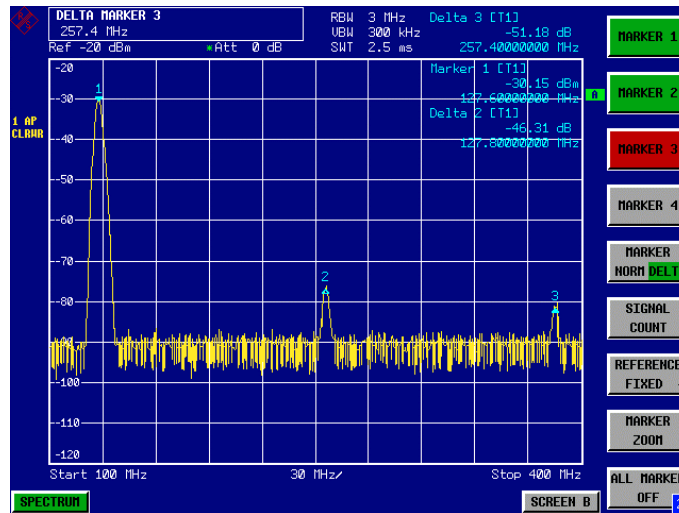

Fig. 2-3 Measuring the harmonic distance of the internal reference generator. Delta marker 2 [T1] and Delta marker 3 [T1] indicate the distance between the fundamental wave and the 2nd and 3rd harmonics.

In order to make the harmonics grow out of the noise, the following things can be done:

- Reducing the video bandwidth
- Averaging the trace
- Reducing the resolution bandwidth

The noise of the analyzer or the DUT (depending on which one is higher) is suppressed by reducing the video bandwidth and by averaging the trace. Especially for low S/N ratios, the measurement uncertainty is reduced using the two averaging methods since the signal under test is also freed from noise.

8. Reduce noise by reducing the video bandwidth

- Press the *BW* key.
- Press the *VIDEO BW MANUAL* softkey.
- Reduce the video bandwidth, e.g. to 10 kHz, using the spinwheel (turn knob counterclockwise), or enter 10 kHz.

The noise is clearly smoothed and the sweep time is increased to 25 ms, i.e. the measurement lasts longer. The displayed video bandwidth is marked with an asterisk (*VBW) to indicate that it is no longer coupled to the resolution bandwidth (see Fig. 2-4).

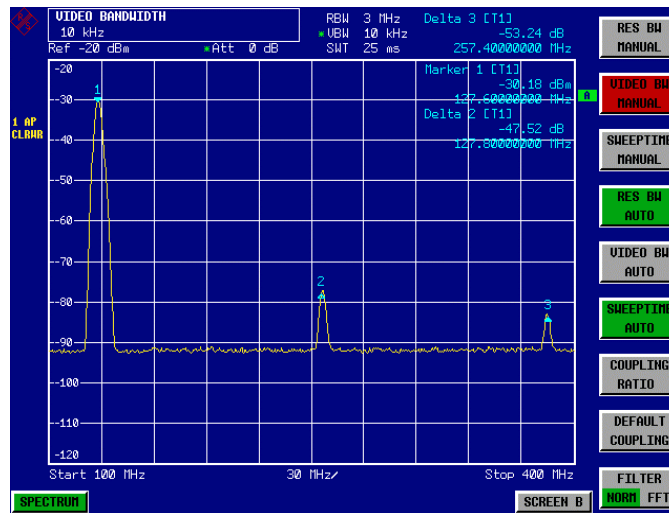

Fig. 2-4 Suppression of noise during harmonic measurement by reducing video bandwidth

9. Coupling the video bandwidth to the resolution bandwidth again.

- Press the *VIDEO BW AUTO* softkey.

10. Reduce noise by averaging the trace

- Press the *TRACE* key.
- Press the *AVERAGE* softkey.
The noise component of the trace is smoothed by averaging 10 consecutive traces.

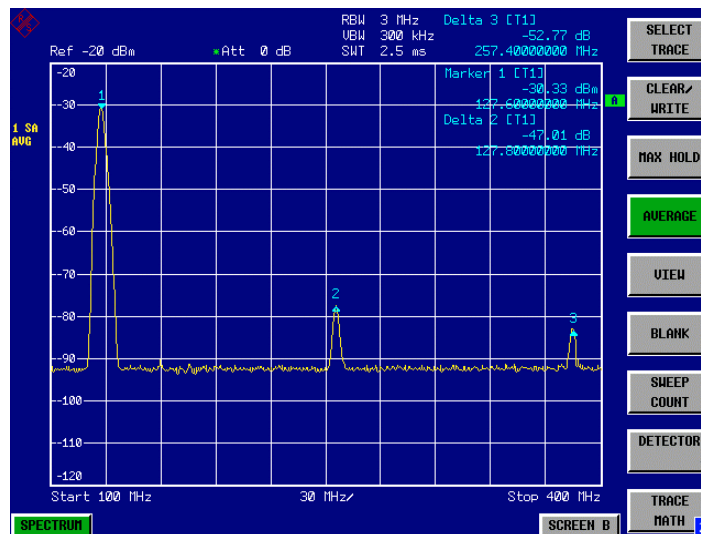

Fig. 2-5 Suppression of noise during harmonic measurements by averaging the trace

11. Switch off trace averaging again.

- Press the *CLEAR/WRITE* softkey.

12. Reduce noise by reducing the measurement bandwidth.

If the resolution bandwidth is decreased, noise is reduced proportionally, i.e. if the resolution bandwidth is reduced by a factor of 10, the noise is also reduced by the same factor (corresponds to 10 dB). The amplitude of a sinusoidal signal is not changed by reducing the resolution bandwidth.

13. Set the resolution bandwidth to 10 kHz.

- Press the *BW* key.
- Press the *RES BW MANUAL* softkey and enter *10 kHz*.
The noise is reduced by approx. 25 dB compared to the previous setting. Since the video bandwidth is coupled to the resolution bandwidth, it is reduced to 1 kHz – the same proportional reduction as the resolution bandwidth. The sweep time is therefore increased to 60 seconds.

14. Reset the resolution bandwidth again (coupling to span).

- Press the *RES BW AUTO* softkey.

If you want to stop the harmonics measurement on the internal reference generator at this point, switch the FSP's RF input on again with the following key sequence.

- Press the *SETUP* key and the softkey sequence *SERVICE - INPUT RF* or press the *PRESET* key.

High-Sensitivity Harmonics Measurements

If harmonics have very small levels, the resolution bandwidth required to measure them must be reduced considerably. The sweep time is, therefore, also increased considerably. In this case, the measurement of individual harmonics is carried out with the spectrum analyzer set to a small span. Only the frequency range around the harmonics will then be measured with a small resolution bandwidth.

Measurement Example

1. Set the spectrum analyzer to its default settings.

- Press the *PRESET* key.
The FSP is in its default state.

2. Switch on the internal reference generator.

- Press the *SETUP* key.
- Press the softkeys *SERVICE - INPUT CAL*.
The internal 128 MHz reference generator is now on. The FSP's RF input is switched off.

3. Set the center frequency to 128 MHz and the span to 100 kHz.

- Press the *FREQ* key.
The frequency menu opens.
- Enter *128* in the entry field from the numeric keypad and terminate with the *MHz* key.
- Press the *SPAN* key.
- Enter *100* in the entry field from the numeric keypad and terminate with the *kHz* key.
The FSP displays the reference signal with a span of 100 kHz and resolution bandwidth of 3 kHz.

4. Switching on the marker.

- Press the *MKR* key.
The marker is positioned on the trace maximum.

5. Set the measured signal frequency and the measured level as reference values

- Press the *REFERENCE FIXED* softkey.
- The position of the marker becomes the reference point. The reference point level is indicated by a horizontal line, the reference point frequency with a vertical line. At the same time, the delta 2 marker is switched on at the marker position.

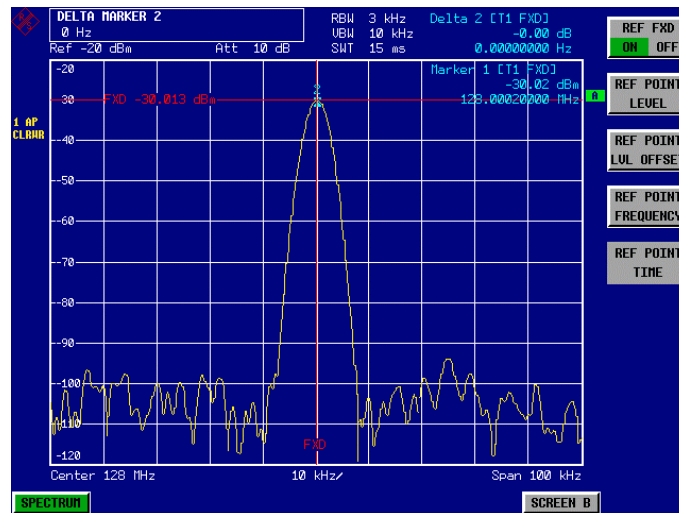

Fig. 2-6 Fundamental wave and the frequency and level reference point

6. Make the step size for the center frequency equal to the signal frequency

- Press the *FREQ* key.
The frequency menu opens.
- Press the *CF STEPSIZE* softkey and press the *=MARKER* softkey in the submenu.
The step size for the center frequency is now equal to the marker frequency.

7. Set the center frequency to the 2nd harmonic of the signal

- Press the *FREQ* key.
The frequency menu opens.
- Press the up cursor key (below the spinwheel) once.
The FSP's center frequency is set to the 2nd harmonic.

8. Place the delta marker on the 2nd harmonic.

- Press the *MKR* → key.
- Press the *PEAK* softkey.
The delta marker jumps to the maximum of the 2nd harmonic. The displayed level result is relative to the reference point level (= fundamental wave level).

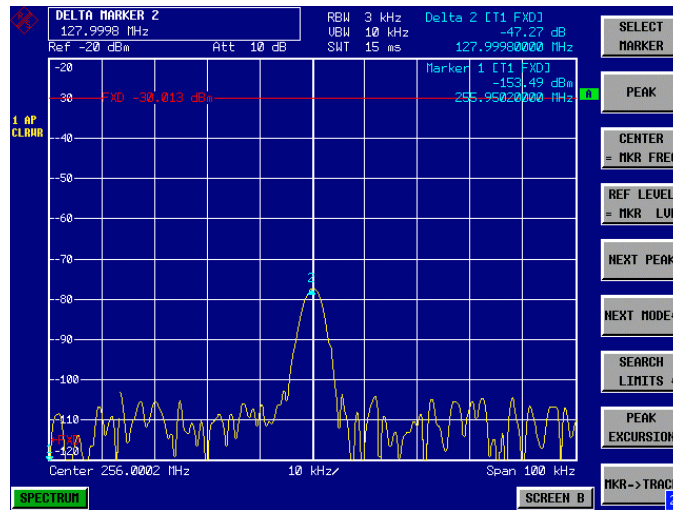

Fig. 2-7 Measuring the level difference between the fundamental wave (= reference point level) and the 2nd harmonic

The other harmonics are measured with steps 6 and 7, the center frequency being incremented or decremented in steps of 128 MHz using the up or down cursor key.

Measuring the Spectra of complex Signals

Separating Signals by Selecting an Appropriate Resolution Bandwidth

One basic characteristics of the spectrum analyzer is that it can separate the spectral components of a composite signal. The resolution with which the individual components are separated is determined by the resolution bandwidth. If the resolution bandwidth is too large, spectral components may no longer be distinct, i.e. they are displayed as a single component.

An RF sinewave signal is displayed on the screen of the spectrum analyzer with the passband characteristics of the set resolution filter (RBW). It is the 3 dB bandwidth of the filter that is displayed.

Two signals with the same amplitude can be resolved if the resolution bandwidth is less than or equal to the signals' frequency difference. If the resolution bandwidth and the frequency difference are equal, a 3 dB level dip can be seen in the middle between the two signals. The smaller the resolution bandwidth, the deeper the level dip and the better the signal resolution.

If there are large level differences between signals, the resolution is determined by selectivity as well as by the resolution bandwidth that has been selected. The measure of selectivity used for spectrum analyzers is the ratio of the 60 dB bandwidth to the 3 dB bandwidth (= shape factor).

For the FSP, the shape factor for bandwidths up to 100 kHz is < 5 and for larger bandwidths < 15, i.e. the 60 dB bandwidth of the 30 kHz filter is < 150 kHz and that of the 300 kHz filter is < 4.5 MHz. Although the 3 dB bandwidths only differ by a factor of 10, the 60 dB bandwidths differ by a factor of 30.

The higher spectral resolution with smaller bandwidths has to be traded off against longer sweep times for the same span. The sweep time required to allow the resolution filters to settle during a sweep at all signal levels and frequencies to be displayed is given by the following formula.

$$SWT = k \cdot \text{Span}/RBW^2 \quad (1)$$

SWT = max. sweep time for correct measurement
 k = factor depending on type of resolution filter
 = 2.5 for analog IF filter (≥ 300 kHz)
 = 1 for digital IF filters (≤ 100 kHz)
 Span = frequency display range
 RBW = resolution bandwidth

If the resolution bandwidth is reduced by a factor of 3, the sweep time is increased by a factor of 9.

Note: *The impact of the video bandwidth on the sweep time is not taken into account in (1). For the formula to be valid, the video bandwidth must be $\geq 3 \times$ the resolution bandwidth.*

For bandwidths > 300 kHz, the FSP uses 4pole, single-section filters. They require a k factor of 2.5 to settle during the frequency sweep. Digital filters with a Gaussian characteristic are used below a bandwidth of 300 kHz (up to 100 kHz). These filters settle at a k factor of 1, i.e. the sweep time is 2.5 times shorter than with conventional 4 or 5 pole, single-section filters.

FFT filters can be used for resolution bandwidths up to 30 kHz. Like digital filters, they have a shape factor of less than 5 up to 30 kHz. For FFT filters, however, the sweep time is given by the following formula:

$$SWT = k \cdot \text{span}/RBW \quad (2)$$

i.e. if the resolution bandwidth is reduced by a factor of 3, the sweep time is increased by a factor of 3 only

Measurement Example - Resolving two signals with a level of -30 dBm each and a frequency difference of 30 kHz

Example:

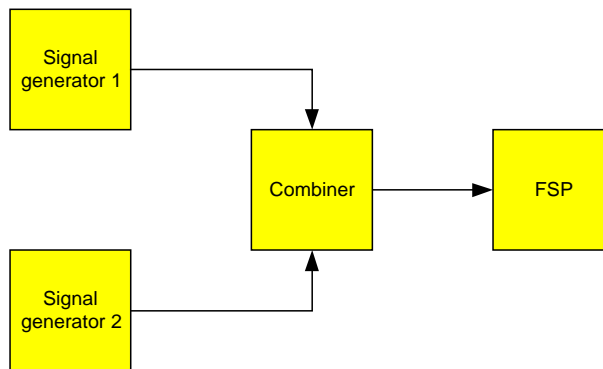

Fig. 2-8 Test setup for generating two signals

Signal generator settings (e.g. SMIQ):

	Level	Frequency
Signal generator 1	-30 dBm	100.00 MHz
Signal generator 2	-30 dBm	100.03 MHz

FSP measurement sequence:

1. Set the spectrum analyzer to its default settings.

- Press the *PRESET* key.
The FSP is in its default state.

2. Set the center frequency to 100.015 MHz and the frequency span to 300 kHz.

- Press the *FREQ* key and enter 100.015 MHz.
- Press the *SPAN* key and enter 300 kHz.

3. Set the resolution bandwidth is to 30 kHz and the video bandwidth to 1 kHz.

- Press the *BW* key.
- Press the *RES BW MANUAL* softkey and enter 30 kHz.
- Press the *VIDEO BW MANUAL* softkey and enter 1 kHz.
- The two signals are clearly separated by a 3 dB level dip in the middle of the screen.

Note: The video bandwidth is set to 1 kHz to clearly display the level dip in the middle between the two signals. At larger video bandwidths, the video voltage which arises from envelope detection is not sufficiently suppressed. Therefore, additional voltages occur between the two signals and can be seen on the trace.

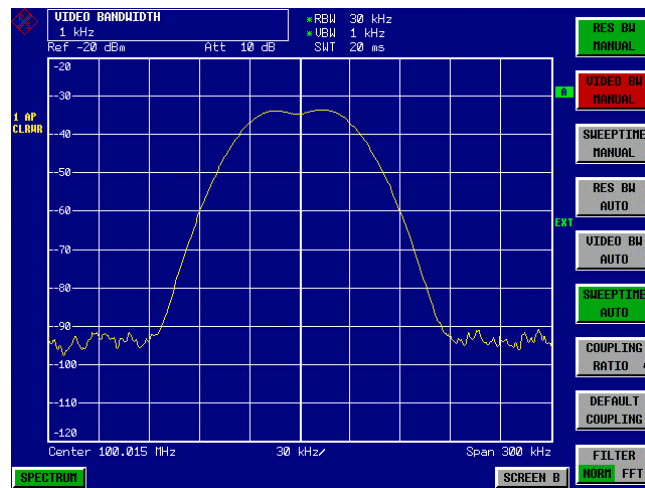

Fig. 2-9 Measurement of two RF sinewave signals with the same level using a resolution bandwidth which corresponds to the frequency difference of the signals.

Note: The level dip is only exactly in the middle of the screen if the generator frequencies exactly correspond with the frequency display of FSP. To ensure this, the generators and the FSP must have their frequencies synchronized.

4. Set the resolution bandwidth to 100 kHz.

- Press the *RES BW MANUAL* softkey and enter 100 kHz.
The two generator signals can no longer be clearly distinguished.

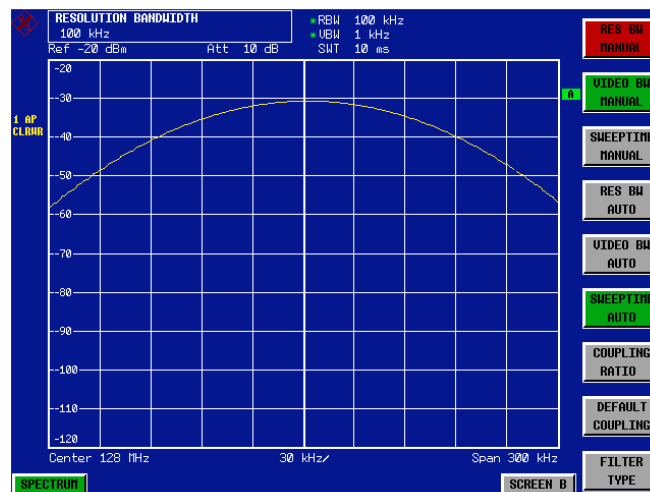

Fig. 2-10 Measurement on two RF sinewave signals with the same level using a resolution bandwidth which is greater than their frequency difference.

The resolution bandwidth (RBW) can be reduced again by turning the spinwheel counterclockwise to obtain a higher frequency resolution.

5. Set the resolution bandwidth to 1 kHz.

- Turn the spinwheel counterclockwise until a bandwidth of 1 kHz is displayed. The two generator signals are displayed at high resolution. The sweep time increases considerably (600 ms) because it increases by $1/RBW^2$. The noise floor also goes down at small resolution bandwidths (10 dB per bandwidth factor of 10).

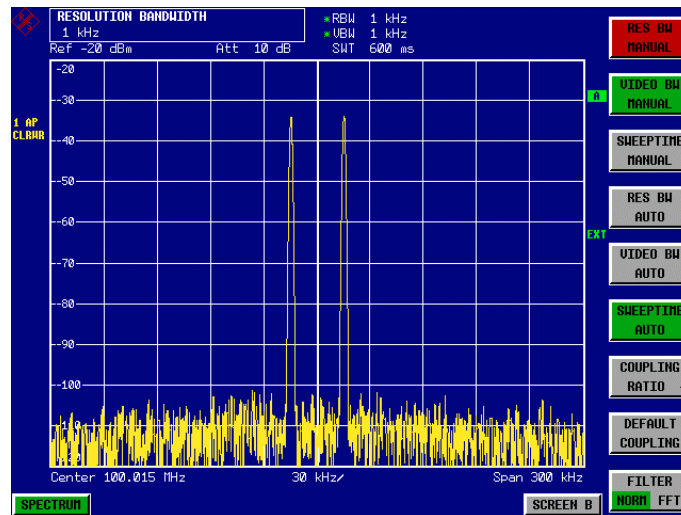

Fig. 2-11 Measurement on two RF sinewave signals with the same level using a resolution bandwidth (1 kHz) which is far below their frequency difference.

6. Switch on the FFT bandwidths.

- Set the *FILTER* softkey to *FFT*. IF filtering is now carried out with the FFT algorithm. The sweep time is considerably reduced from 600 ms to 15 ms (factor of 40). The update rate of the display is increased in almost the same proportion.

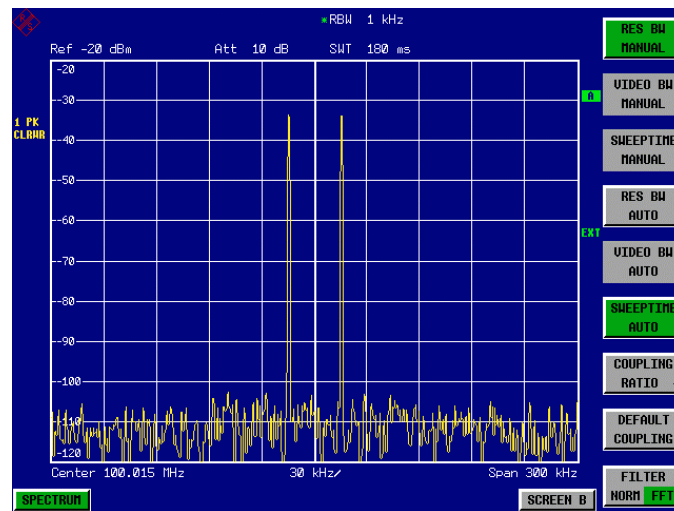

Fig. 2-12 Measurement with FFT filters gives a considerably shorter sweep time and a higher refresh rate.

Intermodulation Measurements

If several signals are applied to a DUT with non-linear characteristics, unwanted mixing products are generated – mostly by active components such as amplifiers or mixers. The products created by 3rd order intermodulation are particularly troublesome as they have frequencies close to the useful signals and, compared with other products, are closest in level to the useful signals. The fundamental wave of one signal is mixed with the 2nd harmonic of the other signal.

$$f_{s1} = 2 \cdot f_{u1} - f_{u2} \quad (1)$$

$$f_{s2} = 2 \cdot f_{u2} - f_{u1} \quad (2)$$

where f_{s1} and f_{s2} are the frequencies of the intermodulation products and f_{u1} and f_{u2} the frequencies of the useful signals.

The following diagram shows the position of the intermodulation products in the frequency domain.

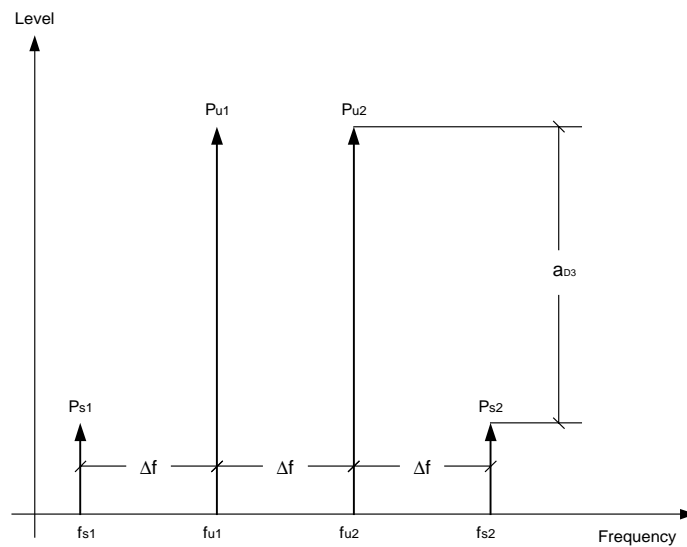

Fig. 2-13 3rd order intermodulation products

Example: $f_{u1} = 100 \text{ MHz}$, $f_{u2} = 100.03 \text{ MHz}$
 $f_{s1} = 2 \cdot f_{u1} - f_{u2} = 2 \cdot 100 \text{ MHz} - 100.03 \text{ MHz} = 99.97 \text{ MHz}$
 $f_{s2} = 2 \cdot f_{u2} - f_{u1} = 2 \cdot 100.03 \text{ MHz} - 100 \text{ MHz} = 100.06 \text{ MHz}$

The level of the intermodulation products depends on the level of the useful signals. If the level of the two useful signals is increased by 1 dB, the level of the intermodulation products is increased by 3 dB. The intermodulation distance d_3 is, therefore, reduced by 2 dB. Fig. 2-14 shows how the levels of the useful signals and the 3rd order intermodulation products are related.

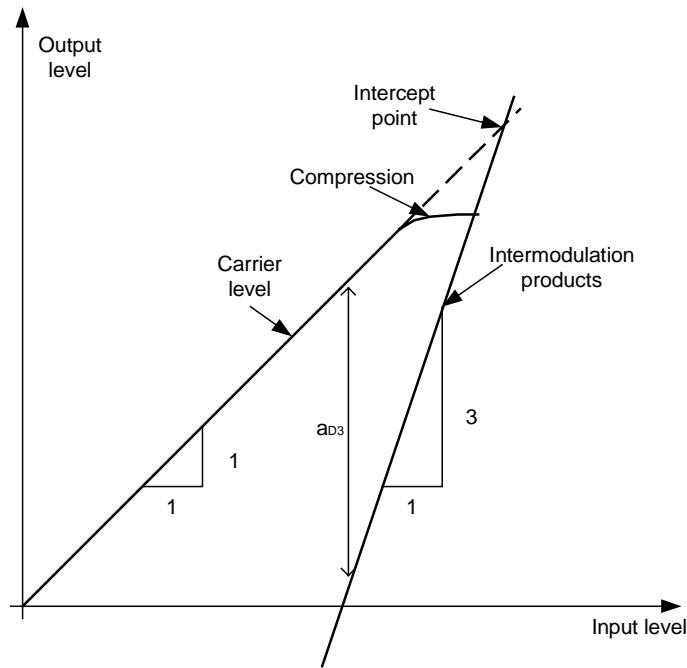

Fig. 2-14 Level of the 3rd order intermodulation products as a function of the level of the useful signals

The behavior of the signals can be explained using an amplifier as an example. The change in the level of the useful signals at the output of the amplifier is proportional to the level change at the input of the amplifier as long as the amplifier is operating in linear range. If the level at the amplifier input is changed by 1 dB, there is a 1 dB level change at the amplifier output. At a certain input level, the amplifier enters saturation. The level at the amplifier output does not increase with increasing input level.

The level of the 3rd order intermodulation products increases 3 times faster than the level of the useful signals. The 3rd order intercept is the virtual level at which the level of the useful signals and the level of the spurious products are identical, i.e. the intersection of the two straight lines. This level cannot be measured directly as the amplifier goes into saturation or is damaged before this level is reached.

The 3rd order intercept can be calculated from the known slopes of the lines, the intermodulation distance d_2 and the level of the useful signals.

$$TOI = a_{D3} / 2 + P_n \tag{3}$$

with TOI (Third Order Intercept) being the 3rd order intercept in dBm and P_n the level of a carrier in dBm.

With an intermodulation distance of 60 dB and an input level, P_w , of -20 dBm, the following 3rd order intercept is obtained:

$$TOI = 60 \text{ dBm} / 2 + (-20 \text{ dBm}) = 10 \text{ dBm}.$$

Measurement Example – Measuring the FSP’s intrinsic intermodulation distance

To measure the intrinsic intermodulation distance, use the test setup in Fig. 2-8.

Signal generator settings (e.g. SMIQ):

	Level	Frequency
Signal generator 1	-10 dBm	999.9 MHz
Signal generator 2	-10 dBm	1000.1 MHz

Measurement using the FSP:

1. Set the spectrum analyzer to its default settings.

- Press the *PRESET* key.
The FSP is in its default state.

2. Set center frequency to 1 GHz and the frequency span to 1 MHz.

- Press the *FREQ* key and enter 1 GHz.
- Press the *SPAN* key and enter 1 MHz.

3. Set the reference level to –10 dBm and RF attenuation to 0 dB.

- Press the *AMPT* key and enter -10 dBm.
- Press the *RF ATTEN MANUAL* softkey and enter 0 dB.
By reducing the RF attenuation to 0 dB, the level to the FSP input mixer is increased. Therefore, 3rd order intermodulation products are displayed.

4. Set the resolution bandwidth to 10 kHz.

- Press the *BW* key.
- Press the *RES BW MANUAL* softkey and enter 10 kHz.
By reducing the bandwidth, the noise is further reduced and the intermodulation products can be clearly seen.

5. Measuring intermodulation by means of the 3rd order intercept measurement function

- Press the *MKR FCTN* key.
- Press the *TOI* softkey.
The FSP activates four markers for measuring the intermodulation distance. Two markers are positioned on the useful signals and two on the intermodulation products. The 3rd order intercept is calculated from the level difference between the useful signals and the intermodulation products. It is then displayed on the screen:

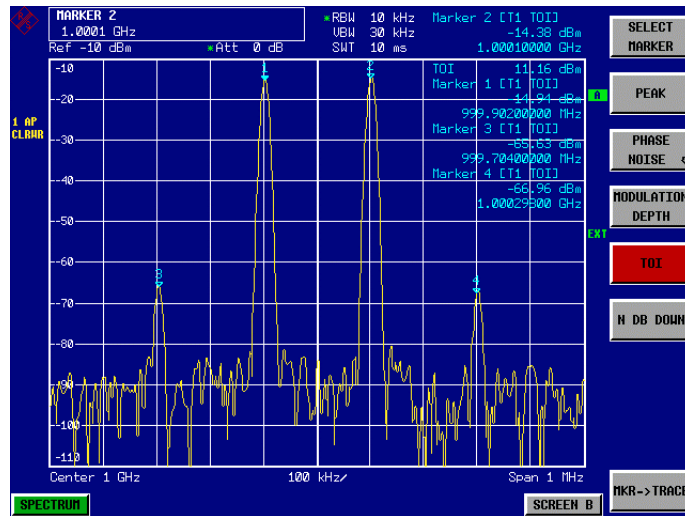

Fig. 2-15 Result of intrinsic intermodulation measurement on the FSP. The 3rd order intercept (TOI) is displayed at the top right corner of the grid

The level of a spectrum analyzer’s intrinsic intermodulation products depends on the RF level of the useful signals at the input mixer. When the RF attenuation is added, the mixer level is reduced and the intermodulation distance is increased. With an additional RF attenuation of 10 dB, the levels of the intermodulation products are reduced by 20 dB. The noise level is, however, increased by 10 dB.

6. Increasing RF attenuation to 10 dB to reduce intermodulation products.

- Press the *AMPT* key.
- Press the *RF ATTEN MANUAL* softkey and enter *10 dB*.
The FSP’s intrinsic intermodulation products disappear below the noise floor.

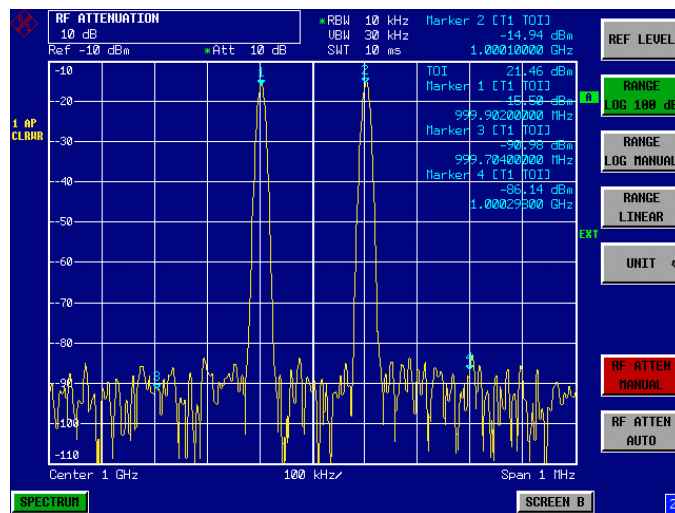

Fig. 2-16 If the RF attenuation is increased, the FSP’s intrinsic intermodulation products disappear below the noise floor.

Calculation method:

The method used by the FSP to calculate the intercept point takes the average useful signal level P_u in dBm and calculates the intermodulation d_3 in dB as a function of the average value of the levels of the two intermodulation products. The third order intercept (TOI) is then calculated as follows:

$$TOI/dBm = \frac{1}{2} d_3 + P_u$$

Intermodulation- free dynamic range

The **Intermodulation – free dynamic range**, i.e. the level range in which no internal intermodulation products are generated if two-tone signals are measured, is determined by the 3rd order intercept point, the phase noise and the thermal noise of the spectrum analyzer. At high signal levels, the range is determined by intermodulation products. At low signal levels, intermodulation products disappear below the noise floor, i.e. the noise floor and the phase noise of the spectrum analyzer determine the range. The noise floor and the phase noise depend on the resolution bandwidth that has been selected. At the smallest resolution bandwidth, the noise floor and phase noise are at a minimum and so the maximum range is obtained. However, a large increase in sweep time is required for small resolution bandwidths. It is, therefore, best to select the largest resolution bandwidth possible to obtain the range that is required. Since phase noise decreases as the carrier-offset increases, its influence decreases with increasing frequency offset from the useful signals.

The following diagrams illustrate the intermodulation-free dynamic range as a function of the selected bandwidth and of the level at the input mixer (= signal level – set RF attenuation) at different useful signal offsets.

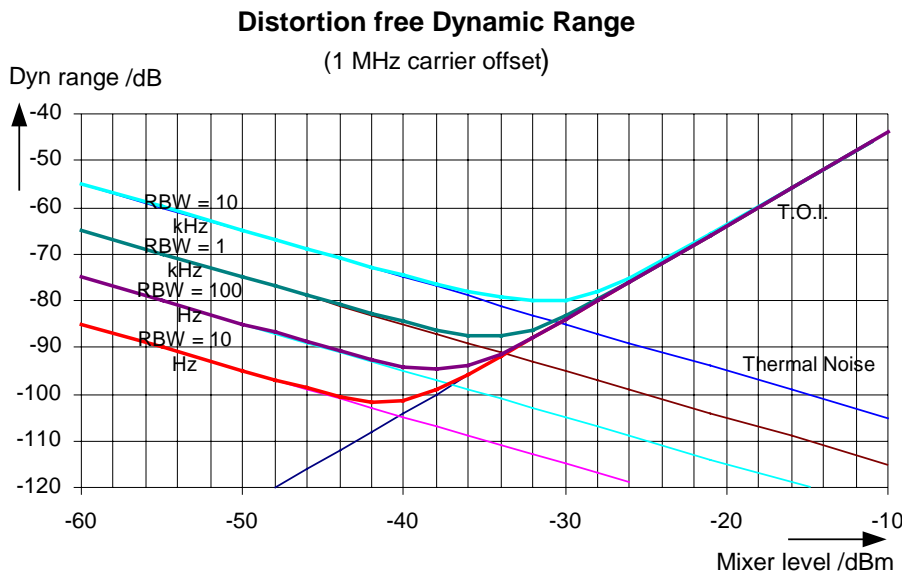

Fig. 2-17 Intermodulation-free range of the FSP3 as a function of level at the input mixer and the set resolution bandwidth (useful signal offset = 1 MHz, DANL = -155 dBm /Hz, TOI = 12 dBm; typ. values at 2 GHz)

The optimum mixer level, i.e. the level at which the intermodulation distance is at its maximum, depends on the bandwidth. At a resolution bandwidth of 10 Hz, it is approx. -42 dBm and at 10 kHz increases to approx. -32 dBm.

Phase noise has a considerable influence on the intermodulation-free range at carrier offsets between 10 and 100 kHz (Fig. 2-18). At greater bandwidths, the influence of the phase noise is greater than it would be with small bandwidths. The optimum mixer level at the bandwidths under consideration becomes almost independent of bandwidth and is approx. -40 dBm.

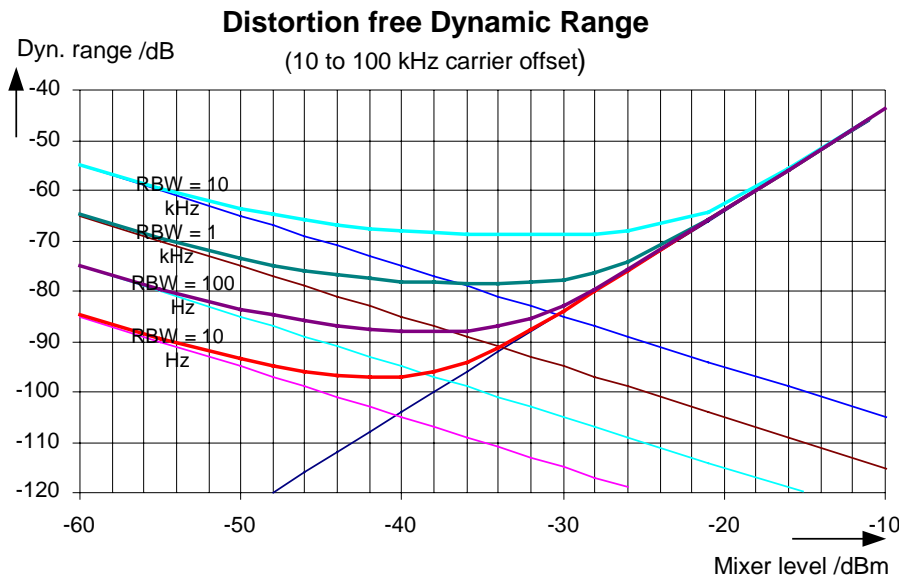

Fig. 2-18 Intermodulation-free dynamic range of the FSP3 as a function of level at the input mixer and of the selected resolution bandwidth (useful signal offset = 10 to 100 kHz, DANL = -155 dBm /Hz, TOI = 12 dBm; typ. values at 2 GHz).

Hint: If the intermodulation products of a DUT with a very high dynamic range are to be measured and the resolution bandwidth to be used is therefore very small, it is best to measure the levels of the useful signals and those of the intermodulation products separately using a small span. The measurement time will be reduced— in particular if the offset of the useful signals is large. To find signals reliably when frequency span is small, it is best to synchronize the signal sources and the FSP.

Measuring Signals in the Vicinity of Noise

The minimum signal level a spectrum analyzer can measure is limited by its intrinsic noise. Small signals can be swamped by noise and therefore cannot be measured. For signals that are just above the intrinsic noise, the accuracy of the level measurement is influenced by the intrinsic noise of the spectrum analyzer.

The displayed noise level of a spectrum analyzer depends on its noise figure, the selected RF attenuation, the selected reference level, the selected resolution and video bandwidth and the detector. The effect of the different parameters is explained in the following.

Impact of the RF attenuation setting

The sensitivity of a spectrum analyzer is directly influenced by the selected RF attenuation. The highest sensitivity is obtained at a RF attenuation of 0 dB. The FSP's RF attenuation can be set in 10 dB steps up to 70 dB (5 dB steps up to 75 dB with option *Electronic Attenuator* FSP-B25). Each additional 10 dB step reduces the FSP's sensitivity by 10 dB, i.e. the displayed noise is increased by 10 dB.

Impact of the reference level setting

If the reference level is changed, the FSP changes the gain on the last IF so that the voltage at the logarithmic amplifier and the A/D converter is always the same for signal levels corresponding to the reference level. This ensures that the dynamic range of the log amp or the A/D converter is fully utilized. Therefore, the total gain of the signal path is low at high reference levels and the noise figure of the IF amplifier makes a substantial contribution to the total noise figure of the FSP. Fig. 2-(21) below shows the change in the displayed noise depending on the set reference level at 10 kHz and 300 kHz resolution bandwidth. With digital bandwidths (≤ 100 kHz) the noise increases sharply at high reference levels because of the dynamic range of the A/D converter.

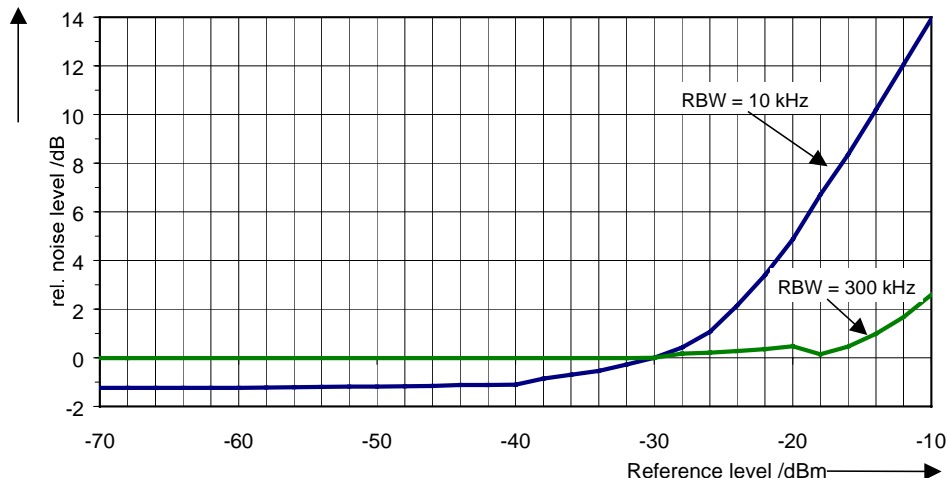

Fig. 2-19 Change in displayed noise as a function of the selected reference level at bandwidths of 10 kHz and 300 kHz (-30 dBm reference level)

Impact of the resolution bandwidth

The sensitivity of a spectrum analyzer also directly depends on the selected bandwidth. The highest sensitivity is obtained at the smallest bandwidth (for the FSP: 10 Hz, for FFT filtering: 1 Hz). If the bandwidth is increased, the reduction in sensitivity is proportional to the change in bandwidth. The FSP has bandwidth settings in 1, 3, 10 sequence. Increasing the bandwidth by a factor of 3 increases the displayed noise by approx. 5 dB (4.77 dB precisely). If the bandwidth is increased by a factor of 10, the displayed noise increases by a factor of 10, i.e. 10 dB. Because of the way the resolution filters are

designed, the sensitivity of spectrum analyzers often depends on the selected resolution bandwidth. In data sheets, the displayed average noise level is often indicated for the smallest available bandwidth (for the FSP: 10 Hz). The extra sensitivity obtained if the bandwidth is reduced may therefore deviate from the values indicated above. The following table illustrates typical deviations from the noise figure for a resolution bandwidth of 10 kHz which is used as a reference value (= 0 dB).

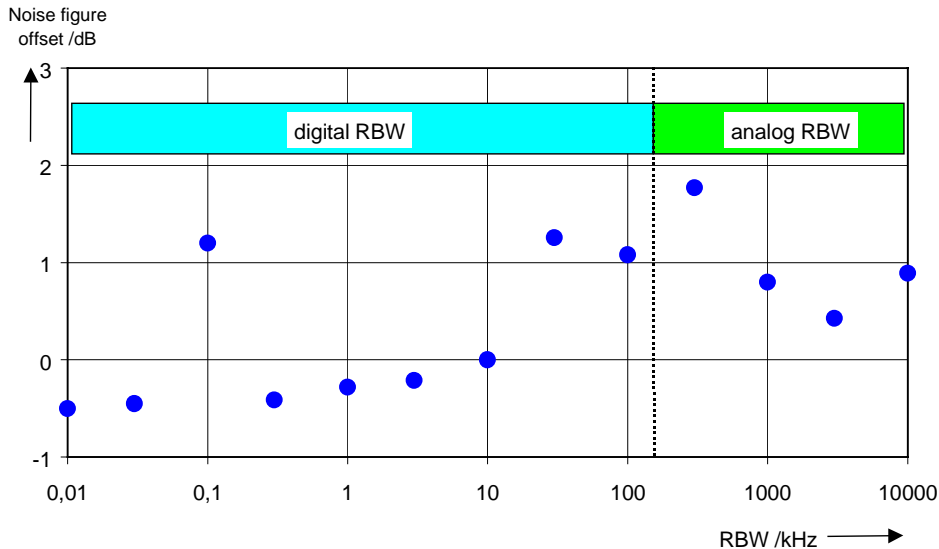

Fig. 2-20 Change in FSP noise figure at various bandwidths. The reference bandwidth is 10 kHz

Impact of the video bandwidth

The displayed noise of a spectrum analyzer is also influenced by the selected video bandwidth. If the video bandwidth is considerably smaller than the resolution bandwidth, noise spikes are suppressed, i.e. the trace becomes much smoother. The level of a sinewave signal is not influenced by the video bandwidth. A sinewave signal can therefore be freed from noise by using a video bandwidth that is small compared with the resolution bandwidth, and thus be measured more accurately.

Impact of the detector

Noise is evaluated differently by the different detectors. The noise display is therefore influenced by the choice of detector. Sinewave signals are weighted in the same way by all detectors, i.e. the level display for a sinewave RF signal does not depend on the selected detector, provided that the signal-to-noise ratio is high enough. The measurement accuracy for signals in the vicinity of intrinsic spectrum analyzer noise is also influenced by the detector which has been selected. The FSP has the following detectors:

Maximum peak detector

If the max. peak detector is selected, the largest noise display is obtained, since the spectrum analyzer displays the highest value of the IF envelope in the frequency range assigned to a pixel at each pixel in the trace. With longer sweep times, the trace indicates higher noise levels since the probability of obtaining a high noise amplitude increases with the dwell time on a pixel. For short sweep times, the display approaches that of the sample detector since the dwell time on a pixel is only sufficient to obtain an instantaneous value.

Minimum peak detector

The min. peak detector indicates the minimum voltage of the IF envelope in the frequency range assigned to a pixel at each pixel in the trace. The noise is strongly suppressed by the minimum peak detector since the lowest noise amplitude that occurs is displayed for each test point. If the signal-to-noise ratio is low, the minimum of the noise overlaying the signal is displayed too low.

At longer sweep times, the trace shows smaller noise levels since the probability of obtaining a low noise amplitude increases with the dwell time on a pixel. For short sweep times, the display approaches that of the sample detector since the dwell time on a pixel is only sufficient to obtain an instantaneous value.

Autoppeak detector

The Autoppeak detector displays the maximum and minimum peak value at the same time. Both values are measured and their levels are displayed on the screen joint by a vertical line.

Sample detector

The sample detector samples the logarithm of the IF envelope for each pixel of the trace only once and displays the resulting value. If the frequency span of the spectrum analyzer is considerably higher than the resolution bandwidth ($\text{span/RBW} > 500$), there is no guarantee that useful signals will be detected. They are lost due to undersampling. This does not happen with noise because in this case it is not the instantaneous amplitude that is relevant but only the probability distribution.

RMS detector

For each pixel of the trace, the RMS detector outputs the RMS value of the IF envelope for the frequency range assigned to each test point. It therefore measures noise power. The display for small signals is, however, the sum of signal power and noise power. For short sweep times, i.e. if only one uncorrelated sample value contributes to the RMS value measurement, the RMS detector is equivalent to the sample detector. If the sweep time is longer, more and more uncorrelated RMS values contribute to the RMS value measurement. The trace is, therefore, smoothed. The level of sinewave signals is only displayed correctly if the selected resolution bandwidth (RBW) is at least as wide as the frequency range which corresponds to a pixel in the trace. At a resolution bandwidth of 1 MHz, this means that the maximum frequency display range is 501 MHz.

Average detector

For each pixel of the trace, the average detector outputs the average value of the linear IF envelope for the frequency range assigned to each test point. It therefore measures the linear average noise. The level of sinewave signals is only displayed correctly if the selected resolution bandwidth (RBW) is at least as wide as the frequency range which corresponds to a pixel in the trace. At a resolution bandwidth of 1 MHz, this means the maximum frequency display range is 501 MHz.

Quasi peak detector

The quasi peak detector is a peak detector for EMI measurements with defined charge and discharge times. These times are defined in CISPR 16, the standard for equipment used to measure EMI emissions.

Measurement example – Measuring the level of the internal reference generator at low S/N ratios

The example shows the different factors influencing the S/N ratio.

1. Set the spectrum analyzer to its default state.

- Press the *PRESET* key.
The FSP is in its default state.

2. Switch on the internal reference generator

- Press the *SETUP* key.
- Press the softkeys *SERVICE - INPUT CAL*.
The internal 128 MHz reference generator is on.
The FSP's RF input is off.

3. Set the center frequency to 128 MHz and the frequency span to 100 MHz.

- Press the *FREQ* key and enter *128 MHz*.
- Press the *SPAN* key and enter *100 MHz*.

4. **Set the RF attenuation to 60 dB to attenuate the input signal or to increase the intrinsic noise.**

- Press the *AMPT* key.
- Press the *RF ATTEN MANUAL* softkey and enter 60 dB.
The RF attenuation indicator is marked with an asterisk (*Att 60 dB) to show that it is no longer coupled to the reference level. The high input attenuation reduces the reference signal which can no longer be detected in noise.

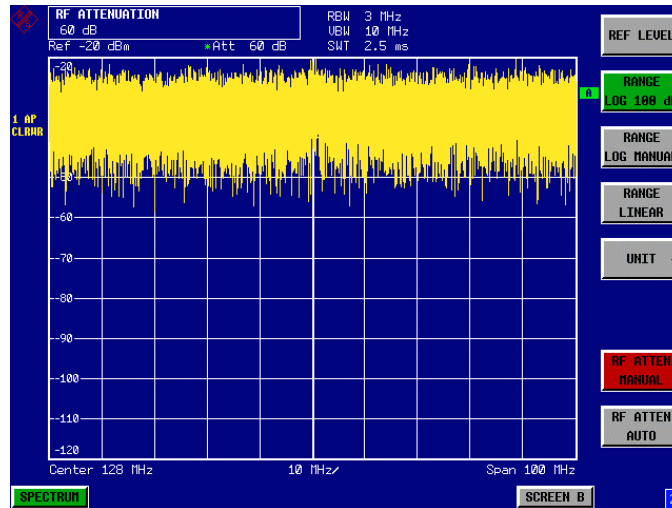

Fig. 2-21 Sinewave signal with low S/N ratio. The signal is measured with the autopeak detector and is completely swamped by the intrinsic noise of the spectrum analyzer.

5. **To suppress noise spikes the trace can be averaged.**

- Press the *TRACE* key.
- Press the *AVERAGE* softkey.
The traces of consecutive sweeps are averaged. To perform averaging, the FSP automatically switches on the sample detector. The RF signal, therefore, can be more clearly distinguished from noise.

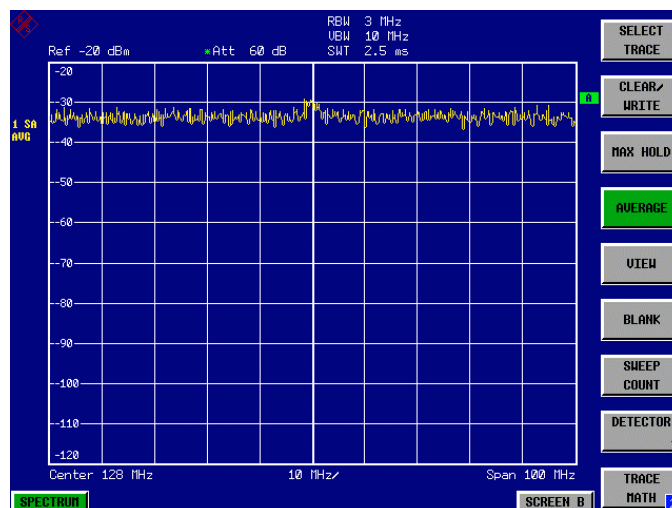

Fig. 2-22 RF sinewave signal with low S/N ratio if the trace is averaged.

6. *Instead of trace averaging, a video filter that is narrower than the resolution bandwidth can be selected.*

- Press the *CLEAR/WRITE* softkey in the trace menu.
- Press the *BW* key.
- Press the *VIDEO BW MANUAL* softkey and enter *10 kHz*.
The RF signal can be more clearly distinguished from noise.

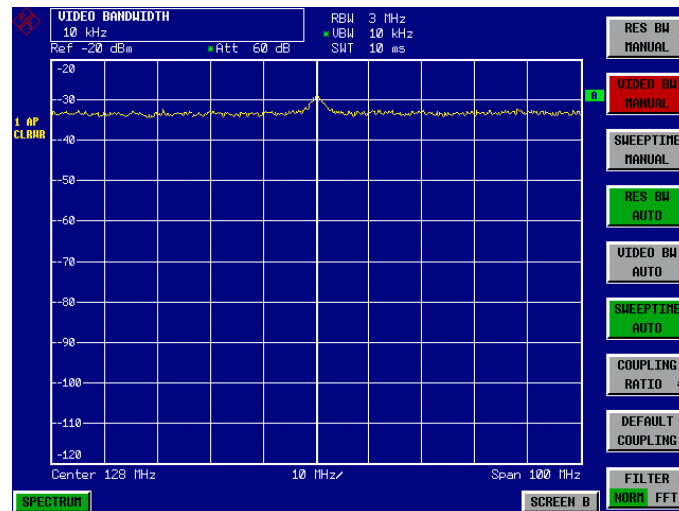

Fig. 2-23 RF sinewave signal with low S/N ratio if a smaller video bandwidth is selected.

7. *By reducing the resolution bandwidth by a factor of 10, the noise is reduced by 10 dB.*

- Press the *RES BW MANUAL* softkey and enter *300 kHz*.
The displayed noise is reduced by approx. 10 dB. The signal, therefore, emerges from noise by about 10 dB. Compared to the previous setting, the video bandwidth has remained the same, i.e. it has increased relative to the smaller resolution bandwidth. The averaging effect is, therefore, reduced by the video bandwidth. The trace will be noisier.

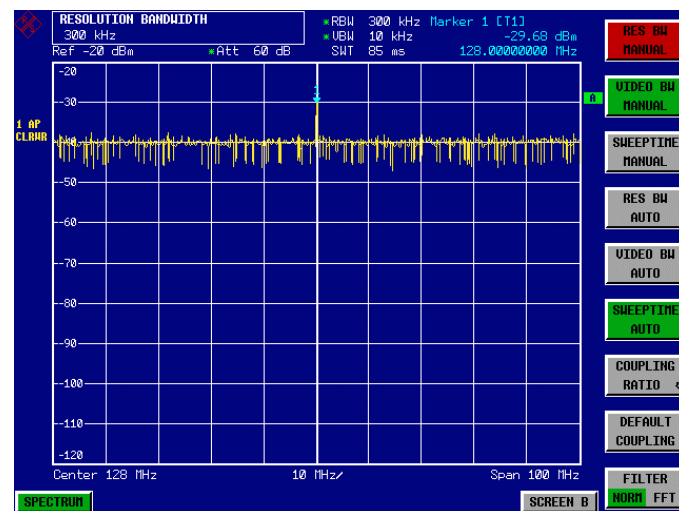

Fig. 2-24 Reference signal at a smaller resolution bandwidth

Noise Measurements

Noise measurements play an important role in spectrum analysis. Noise e.g. affects the sensitivity of radiocommunication systems and their components.

Noise power is specified either as the total power in the transmission channel or as the power referred to a bandwidth of 1 Hz. The sources of noise are, for example, amplifier noise or noise generated by oscillators used for the frequency conversion of useful signals in receivers or transmitters. The noise at the output of an amplifier is determined by its noise figure and gain.

The noise of an oscillator is determined by phase noise near the oscillator frequency and by thermal noise of the active elements far from the oscillator frequency. Phase noise can mask weak signals near the oscillator frequency and make them impossible to detect.

Measuring noise power density

To measure noise power referred to a bandwidth of 1 Hz at a certain frequency, the FSP has an easy-to-use marker function. This marker function calculates the noise power density from the measured marker level.

Measurement example – Measuring the intrinsic noise power density of the FSP at 1 GHz and calculating the FSP's noise figure.

1. Set the spectrum analyzer to its default state.

- Press the *PRESET* key.
The FSP is in its default state.

2. Set the center frequency to 1 GHz and the span to 1 MHz.

- Press the *FREQ* key and enter *1 GHz*.
- Press the *SPAN* key and enter *1 MHz*.

3. Switch on the marker and set the marker frequency to 1 GHz.

- Press the *MKR* key and enter *1 GHz*.

4. Switch on the noise marker function.

- Press the *NOISE MARKER* softkey.
The FSP displays the noise power at 1 GHz in dBm (1Hz).

Since noise is random, a sufficiently long measurement time has to be selected to obtain stable measurement results. This can be achieved by averaging the trace or by selecting a very small video bandwidth relative to the resolution bandwidth.

5. The measurement result is stabilized by averaging the trace

- Press the *TRACE* key.
- Press the *AVERAGE* softkey.
The FSP performs sliding averaging over 10 traces from consecutive sweeps. The measurement result becomes more stable.

Conversion to other reference bandwidths

The result of the noise measurement can be referred to other bandwidths by simple conversion. This is done by adding $10 \cdot \log(BW)$ to the measurement result, BW being the new reference bandwidth.

Example:

A noise power of -150 dBm (1 Hz) is to be referred to a bandwidth of 1 kHz.

$$P_{[1\text{kHz}]} = -150 + 10 \cdot \log(1000) = -150 + 30 = -120 \text{ dBm}(1 \text{ kHz})$$

Calculation method:

The following method is used to calculate the noise power:

If the noise marker is switched on, the FSP automatically activates the sample detector. The video bandwidth is set to 1/10 of the selected resolution bandwidth (RBW).

To calculate the noise, the FSP takes an average over 17 adjacent pixels (the pixel on which the marker is positioned and 8 pixels to the left, 8 pixels to the right of the marker). The measurement result is stabilized by video filtering and averaging over 17 pixels.

Since both video filtering and averaging over 17 trace points is performed in the log display mode, the result would be 2.51 dB too low (difference between logarithmic noise average and noise power). The FSP, therefore, corrects the noise figure by 2.51 dB.

To standardize the measurement result to a bandwidth of 1 Hz, the result is also corrected by $-10 \cdot \log(RBW_{\text{noise}})$, with RBW_{noise} being the power bandwidth of the selected resolution filter (RBW).

Detector selection

The noise power density is measured in the default setting with the sample detector and using averaging. Other detectors that can be used to perform a measurement giving true results are the average detector or the RMS detector. If the average detector is used, the linear video voltage is averaged and displayed as a pixel. If the RMS detector is used, the squared video voltage is averaged and displayed as a pixel. The averaging time depends on the selected sweep time ($=\text{SWT}/501$). An increase in the sweep time gives a longer averaging time per pixel and thus stabilizes the measurement result. The FSP automatically corrects the measurement result of the noise marker display depending on the selected detector (+1.05 dB for the average detector, 0 dB for the RMS detector). It is assumed that the video bandwidth is set to at least three times the resolution bandwidth. While the average or RMS detector is being switched on, the FSP sets the video bandwidth to a suitable value.

The Pos Peak, Neg Peak, Auto Peak and Quasi Peak detectors are not suitable for measuring noise power density.

Determining the noise figure:

The noise figure of amplifiers or of the FSP alone can be obtained from the noise power display. Based on the known thermal noise power of a 50 Ω resistor at room temperature (-174 dBm (1Hz)) and the measured noise power P_{noise} the noise figure (NF) is obtained as follows:

$$\text{NF} = P_{\text{noise}} + 174 - g,$$

where g = gain of DUT in dB

Example: The measured internal noise power of the FSP at an attenuation of 0 dB is found to be -153 dBm/1 Hz. The noise figure of the FSP is obtained as follows

$$\text{NF} = -153 + 174 = 19 \text{ dB}$$

Note: If noise power is measured at the output of an amplifier, for example, the sum of the internal noise power and the noise power at the output of the DUT is measured. The noise power of the DUT can be obtained by subtracting the internal noise power from the total power (subtraction of linear noise powers). By means of the following diagram, the noise level of the DUT can be estimated from the level difference between the total and the internal noise level.

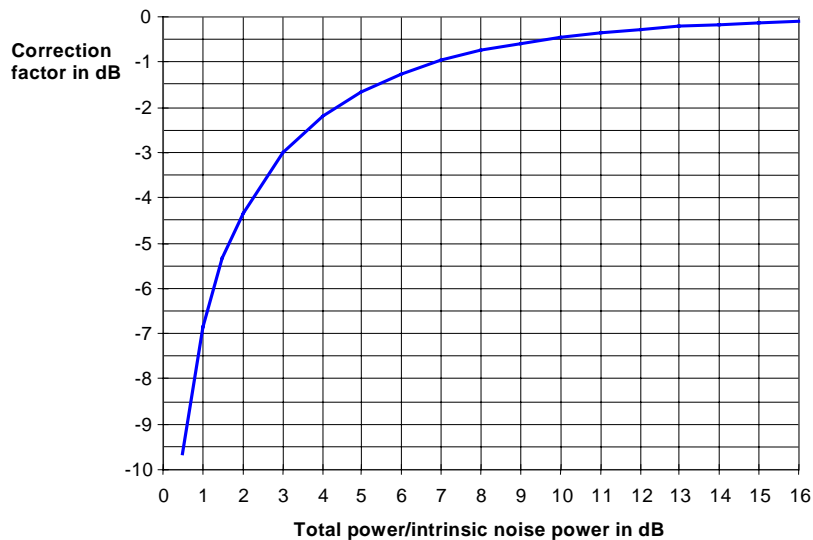

Fig. 2-25 Correction factor for measured noise power as a function of the ratio of total power to the intrinsic noise power of the spectrum analyzer.

Measurement of Noise Power within a Transmission Channel

Noise in any bandwidth can be measured with the channel power measurement functions. Thus the noise power in a communication channel can be determined, for example. If the noise spectrum within the channel bandwidth is flat, the noise marker from the previous example can be used to determine the noise power in the channel by considering the channel bandwidth. If, however, phase noise and noise that normally increases towards the carrier is dominant in the channel to be measured, or if there are discrete spurious signals in the channel, the channel power measurement method must be used to obtain correct measurement results.

Measurement Example – Measuring the intrinsic noise of the FSP at 1 GHz in a 1.23 MHz channel bandwidth with the channel power function

Test setup:

The RF input of the FSP remains open-circuited or is terminated with 50 Ω .

Measurement with the FSP:

1. Set the spectrum analyzer to its default state.

- Press the *PRESET* key.
The FSP is in its default state.

2. Set the center frequency to 1 GHz and the span to 1 MHz.

- Press the *FREQ* key and enter 1 GHz.
- Press the *SPAN* key and enter 2 MHz.

3. To obtain maximum sensitivity, set RF attenuation on the FSP to 0 dB.

- Press the *AMPT* key.
- Press the *RF ATTEN MANUAL* softkey and enter 0 dB.

4. Switch on and configure the channel power measurement.

- Press the *MEAS* key.
- Press the *CHAN POWER / ACP* softkey.
The FSP activates the channel or adjacent channel power measurement according to the currently set configuration.
- Press the *CP/ACP CONFIG* \updownarrow softkey.
The FSP enters the submenu for configuring the channel.
- Press the *CHANNEL BANDWIDTH* softkey and enter 1.23 MHz.
The FSP displays the 1.23 MHz channel as two vertical lines which are symmetrical to the center frequency.
- Press the *PREV* key.
The FSP returns to the main menu for channel and adjacent channel power measurement.
- Press the *ADJUST SETTINGS* softkey.
The settings for the frequency span, the bandwidth (RBW and VBW) and the detector are automatically set to the optimum values required for the measurement.

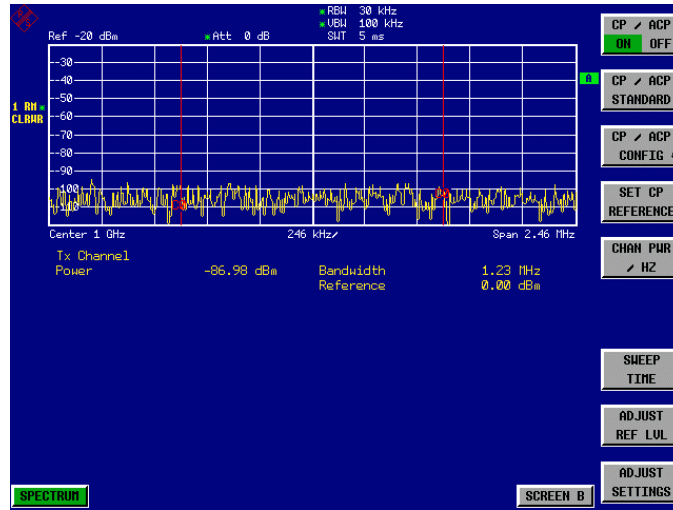

Fig. 2-26 Measurement of the FSP's intrinsic noise power in a 1.23 MHz channel bandwidth.

5. Stabilizing the measurement result by increasing the sweep time

- Press the *SWEEP TIME* softkey and enter 1 s.
By increasing the sweep time to 1 s, the trace becomes much smoother thanks to the RMS detector and the channel power measurement display is much more stable.

6. Referring the measured channel power to a bandwidth of 1 Hz

- Press the *CHAN PWR / Hz* softkey.
The channel power is referred to a bandwidth of 1 Hz. The measurement is corrected by $-10 * \log(\text{ChanBW})$, with ChanBW being the channel bandwidth that was selected.

Method of calculating the channel power

When measuring the channel power, the FSP integrates the linear power which corresponds to the levels of the pixels within the selected channel. The analyzer uses a resolution bandwidth which is far smaller than the channel bandwidth. When sweeping over the channel, the channel filter is formed by the passband characteristics of the resolution bandwidth (see Fig. 2-27).

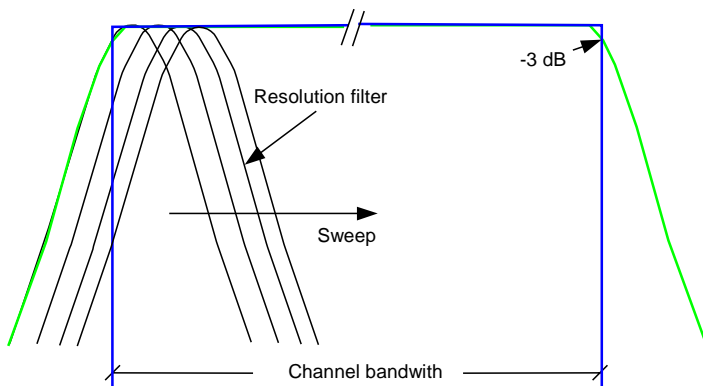

Fig. 2-27 Approximating the channel filter by sweeping with a small resolution bandwidth

The following steps are performed:

- The linear power of all the trace pixels within the channel is calculated.

$$P_i = 10^{(L_i/10)}$$

where P_i = power of the trace pixel i

L_i = displayed level of trace point i

- The powers of all trace pixels within the channel are summed up and the sum is divided by the number of trace pixels in the channel.
- The result is multiplied by the quotient of the selected channel bandwidth and the noise bandwidth of the resolution filter (RBW).

Since the power calculation is performed by integrating the trace within the channel bandwidth, this method is also called the IBW method (Integration Bandwidth method).

Bandwidth selection (RBW)

For channel power measurements, the resolution bandwidth (RBW) must be small compared to the channel bandwidth, so that the channel bandwidth can be defined precisely. If the resolution bandwidth which has been selected is too wide, this may have a negative effect on the selectivity of the simulated channel filter and result in the power in the adjacent channel being added to the power in the transmit channel. A resolution bandwidth equal to 1% to 3% of the channel bandwidth should, therefore, be selected. If the resolution bandwidth is too small, the required sweep time becomes too long and the measurement time increases considerably.

Detector selection

Since the power of the trace is measured within the channel bandwidth, only the sample detector and RMS detector can be used. These detectors provide measured values that make it possible to calculate the real power. The peak detectors (Pos Peak, Neg Peak and Auto Peak) are not suitable for noise power measurements as no correlation can be established between the peak value of the video voltage and power.

With the **sample detector**, a value (sample) of the IF envelope voltage is displayed at each trace pixel. Since the frequency spans are very large compared with the resolution bandwidth ($\text{span}/\text{RBW} > 501$), sinewave signals present in the noise might be lost, i.e. they are not displayed. This is not important for pure noise signals, however, since a single sample in itself is not important - it is the probability distribution of all measured values that counts. The number of samples for power calculation is limited to the number of trace pixels (501 for the FSP).

Note: To increase the repeatability of measurements, averaging is often carried out over several traces (**AVERAGE** softkey in the **TRACE** menu). This gives spurious results for channel power measurements (max. -2.51 dB for ideal averaging). Trace averaging should, therefore, be avoided.

With the **RMS detector**, the whole IF envelope is used to calculate the power for each trace pixel. The IF envelope is digitized using a sampling frequency which is at least five times the resolution bandwidth which has been selected. Based on the sample values, the power is calculated for each trace pixel using the following formula:

$$P_{\text{RMS}} = \sqrt{\frac{1}{N} \cdot \sum_{i=1}^N s_i^2}$$

s_i = linear digitized video voltage at the output of the A/D converter

N = number of A/D converter values per pixel of the trace

P_{RMS} = power represented by a trace pixel

When the power has been calculated, the power units are converted into decibels and the value is displayed as a trace pixel.

The number of A/D converter values, N , used to calculate the power, is defined by the sweep time. The time per trace pixel for power measurements is directly proportional to the selected sweep time. The RMS detector uses far more samples for power measurement than the sample detector, especially if the sweep time is increased. The measurement uncertainty can be reduced considerably. In the default setting, the FSP therefore uses the RMS detector to measure the channel power.

For both detectors (sample and RMS), the video bandwidth (VBW) must at least be three times the resolution bandwidth, so that the peak values of the video voltage are not cut off by the video filter. At smaller video bandwidths, the video signal is averaged and the power readout will be too small.

Sweep time selection

If the sample detector is used, it is best to select the smallest sweep time possible for a given span and resolution bandwidth. The minimum time is obtained if the setting is coupled. This means that the time per measurement is minimal. Extending the measurement time does not have any advantages as the number of samples for calculating the power is defined by the number of trace pixels in the channel.

When using the RMS detector, the repeatability of the measurement results can be influenced by the selection of sweep times. Repeatability is increased at longer sweep times. Repeatability can be estimated from the following diagram:

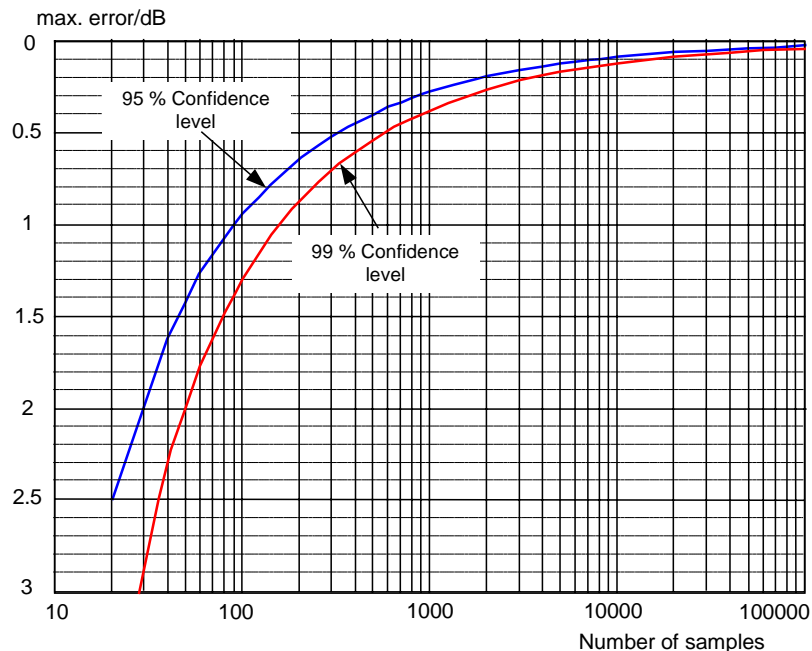

Fig. 2-28 Repeatability of channel power measurements as a function of the number of samples used for power calculation

The curves in Fig. 2-28 indicates the repeatability obtained with a probability of 95% and 99% depending on the number of samples used.

The repeatability with 600 samples is ± 0.5 dB. This means that – if the sample detector and a channel bandwidth over the whole diagram (channel bandwidth = span) is used - the measured value lies within ± 0.5 dB of the true value with a probability of 99%.

If the RMS detector is used, the number of samples can be estimated as follows:

Since only uncorrelated samples contribute to the RMS value, the number of samples can be calculated from the sweep time and the resolution bandwidth.

Samples can be assumed to be uncorrelated if sampling is performed at intervals of $1/\text{RBW}$. The number of uncorrelated samples (N_{decorr}) is calculated as follows:

$$N_{\text{decorr}} = \text{SWT} \cdot \text{RBW}$$

The number of uncorrelated samples per trace pixel is obtained by dividing N_{decorr} by 501 (= pixels per trace).

Example:

At a resolution bandwidth of 30 kHz and a sweep time of 100 ms, 3000 uncorrelated samples are obtained. If the channel bandwidth is equal to the frequency display range, i.e. all trace pixels are used for the channel power measurement, a repeatability of 0.2 dB with a confidence level of 99% is the estimate that can be derived from Fig. 2-28.

Measuring Phase Noise

The FSP has an easy-to-use marker function for phase noise measurements. This marker function indicates the phase noise of an RF oscillator at any carrier in dBc in a bandwidth of 1 Hz.

Measurement Example - Measuring the phase noise of a signal generator at a carrier offset of 10 kHz.

Test setup:

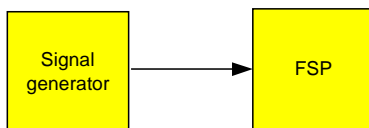

Settings on the signal generator (e.g. R&S SMIQ):

Frequency: 100 MHz
Level: 0 dBm

Measurement using FSP:

1. **Set the spectrum analyzer to its default state**
 - Press the *PRESET* key.
FSP is in its default state.
2. **Set the center frequency to 100 MHz and the span to 50 kHz**
 - Press the *FREQ* key and enter 100 MHz.
 - Press the *SPAN* key and enter 50 kHz.
3. **Set the FSP's reference level to 0 dBm (=signal generator level)**
 - Press the *AMPT* key and enter 0 dBm.

4. Enable phase noise measurement

- Press the *MKR FCTN* key.
- Press the *PHASE NOISE* ∇ softkey.
The FSP activates phase noise measurement. Marker 1 (=main marker) and marker 2 (= delta marker) are positioned on the signal maximum. The position of the marker is the reference (level and frequency) for the phase noise measurement. A horizontal line represents the level of the reference point and a vertical line the frequency of the reference point. Data entry for the delta marker is activated so that the frequency offset at which the phase noise is to be measured can be entered directly.

5. 10 kHz frequency offset for determining phase noise.

- Enter 10 kHz.
The FSP displays the phase noise at a frequency offset of 10 kHz. The magnitude of the phase noise in dBc/Hz is displayed in the delta marker output field at the top right of the screen (delta 2 [T1 PHN]).

6. Stabilize the measurement result by activating trace averaging.

- Press the *TRACE* key.
- Press the *AVERAGE* softkey.

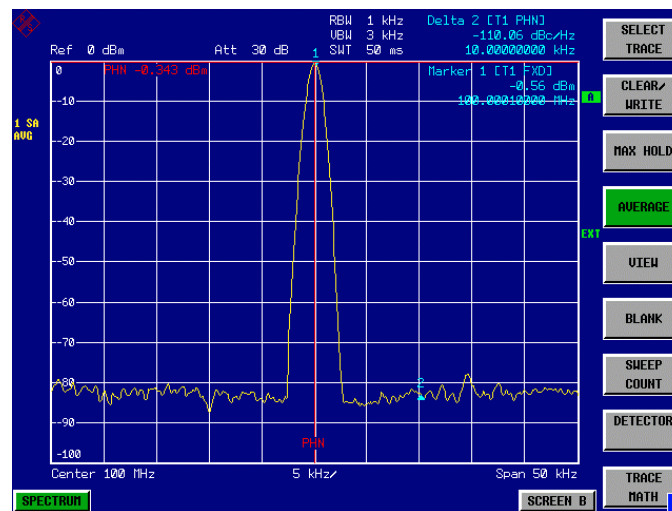

Fig. 2-29 Measuring phase noise with the phase-noise marker function

The frequency offset can be varied by moving the marker with the spinwheel or by entering a new frequency offset as a number.

Measurements on Modulated Signals

If RF signals are used to transmit information, an RF carrier is modulated. Analog modulation methods such as amplitude modulation, frequency modulation and phase modulation have a long history and digital modulation methods are now used for modern systems. Measuring the power and the spectrum of modulated signals is an important task to assure transmission quality and to ensure the integrity of other radio services. This task can be performed easily with a spectrum analyzer. Modern spectrum analyzers also provide the test routines that are essential to simplify complex measurements.

Measurements on AM signals

The spectrum analyzer detects the RF input signal and displays the magnitudes of its components as a spectrum. AM modulated signals are also demodulated by this process. The AF voltage can be displayed in the time domain if the modulation sidebands are within the resolution bandwidth. In the frequency domain, the AM sidebands can be resolved with a small bandwidth and can be measured separately. This means that the modulation depth of a carrier modulated with a sinewave signal can be measured. Since the dynamic range of a spectrum analyzer is very wide, even extremely small modulation depths can be measured accurately. The FSP has a test routine which measures the modulation depth in %.

Measurement Example 1 – Displaying the AF of an AM signal in the time domain.

Test setup:

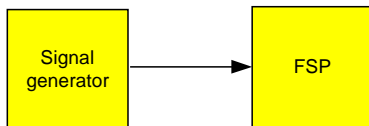

Settings on the signal generator (e.g. R&S SMIQ):

Frequency: 100 MHz
Level: 0 dBm
Modulation: 50 % AM, 1 kHz AF

Measurement with the FSP:

- 1. Set the spectrum analyzer to its default state**
 - Press the *PRESET* key.
The FSP is in its default state.
- 2. Set the center frequency to 100 MHz and the span to 0 kHz**
 - Press the *FREQ* key and enter *100 MHz*.
 - Press the *SPAN* key and enter *0 Hz*.
- 3. Set the reference level to +6 dBm and the display range to linear**
 - Press the *AMPT* key and enter *6 dBm*.
 - Press the *RANGE LINEAR* softkey.

4. Use the video trigger to trigger on the AF signal in order to obtain a stationary display

- Press the *TRIG* key.
- Press the *VIDEO* softkey.
The video trigger level is set to 50% if the instrument is switched on for the first time. The trigger level is displayed as a horizontal line across the graph. The FSP displays the 1 kHz AF signal stably in the time domain.

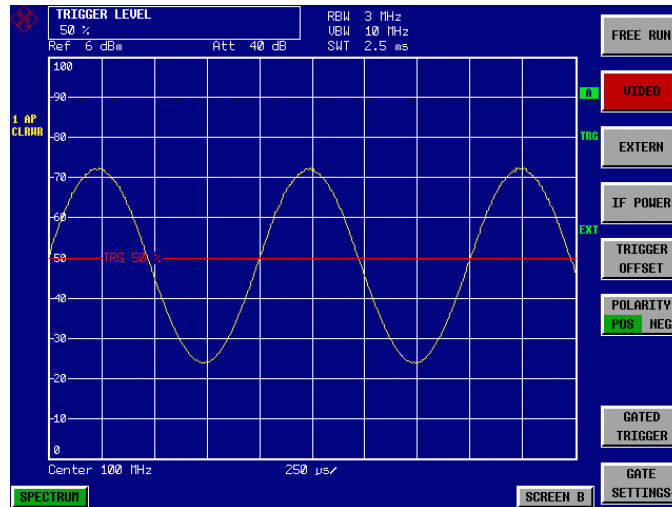

Fig. 2-30 Measuring the AF signal from a 1 kHz AM carrier

If the FSP is equipped with the AM/FM Demodulator option (FSP-B3), the AF can be monitored on the built-in loudspeaker.

5. Switch on the internal AM demodulator

- Press the *MKR FCTN* key.
- Press the *MKR DEMOD* softkey.
The FSP switches the AM demodulator on automatically.
- Turn up volume control.
A 1 kHz tone is output by the built-in loudspeaker.

Measurement Example 2 - Measuring the modulation depth of an AM carrier in the frequency domain.

Test setup:

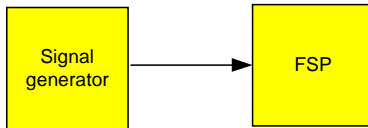

Settings on the signal generator (e.g. R&S SMIQ):

Frequency: 100 MHz
 Level: -30 dBm
 Modulation: 50 % AM, 1 kHz AF

Measurement with the FSP:

1. Set the spectrum analyzer to its default state

- Press the PRESET key.
The FSP is in its default state.

2. Set the center frequency to 100 MHz and the span to 0 kHz

- Press the *FREQ* key and enter 100 MHz.
- Press the *SPAN* key and enter 5 kHz.

3. Activate the marker function for AM depth measurement

- Press the *MKR FCTN* key.
- Press the *MODULATION DEPTH* softkey.
The FSP automatically positions a marker on the carrier signal in the middle of the graph and one delta marker on each of the lower and upper AM sidebands. The FSP calculates the AM modulation depth from the ratios of the delta marker levels to the main marker level and outputs the numerical value in the marker info field

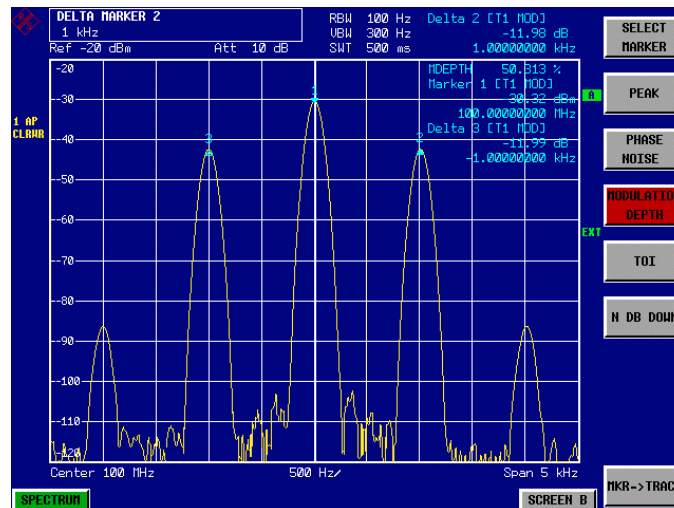

Fig. 2-31 Measurement of AM modulation depth. The modulation depth is indicated by MDEPTH. The frequency of the AF signal is indicated by the delta markers

Measurements on FM Signals

Since spectrum analyzers only display the magnitude of signals by means of the envelope detector, the modulation of FM signals cannot be directly measured as is the case with AM signals. With FM signals, the voltage at the output of the envelope detector is constant as long as the frequency deviation of the signal is within the flat part of the passband characteristic of the resolution filter which has been selected. Amplitude variations can only occur if the current frequency lies on the falling edge of the filter characteristic. This effect can be used to demodulate FM signals. The center frequency of the analyzer is set in a way that the nominal frequency of the test signal is on the filter edge (below or above the center frequency). The resolution bandwidth and the frequency offset are selected in a way that the current frequency is on the linear part of the filter slope. The frequency variation of the FM signal is then transformed into an amplitude variation which can be displayed in the time domain.

The FSP's analog 4th order filters with frequencies from 300 kHz to 3 MHz have a good filter-slope linearity, if the frequency of the FSP is set to 1.2 times the filter bandwidth below or above the frequency of the transmit signal. The useful range for FM demodulation is then almost equal to the resolution bandwidth.

Measurement Example - Displaying the AF of an FM carrier

Test setup:

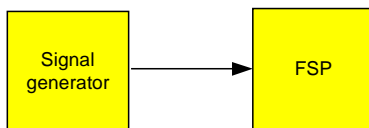

Settings on the signal generator (e.g. R&S SMIQ):

Frequency: 100 MHz

Level: -30 dBm

Modulation: FM 0 kHz deviation (i.e., FM = off), 1 kHz AF

Measurement with the FSP:

1. Set the spectrum analyzer to its default state

- Press the *PRESET* key.
The FSP is in its default state.

2. Set the center frequency to 99.64 MHz and the span to 300 kHz.

- Press the *FREQ* key and enter 99.64 MHz.
- Press the *SPAN* key and enter 300 kHz.

3. Set a resolution bandwidth of 300 kHz.

- Press the *BW* key.
- Press the *RES BW MANUAL* softkey and enter 300 kHz.

4. Set a display range of 20 dB and shift the filter characteristics to the middle of the display.

- Press the *AMPT* key.
- Press the *RANGE LOG MANUAL* softkey and enter 20 dB.
- Press the *NEXT* key.
- Set the *GRID* softkey to *REL*.

- Press the *PREV* softkey.
- Using the spinwheel, shift the reference level so that the filter edge intersects the -10 dB level line at the center frequency.

The slope of the 300 kHz filter is displayed. This corresponds to the demodulator characteristics for FM signals with a slope of approx. 5 dB/100 kHz.

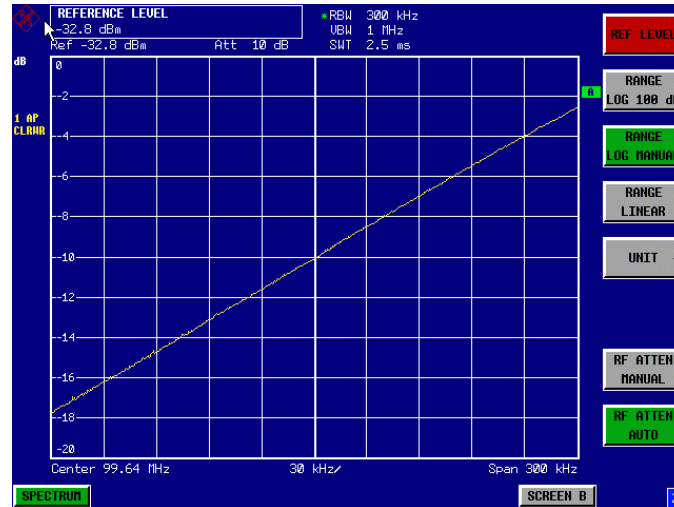

Fig. 2-32 Filter edge of a 300 kHz filter used as an FM-discriminator characteristic

5. Set an FM deviation of 100 kHz and an AF of 1 kHz on the signal generator

6. Set a frequency deviation of 0 Hz on the FSP

- Press the SPAN key.
- Press the ZERO SPAN.
The demodulated FM signal is displayed. The signal moves across the screen.

7. Creating a stable display by video triggering

- Press the TRIG key.
- Press the VIDEO softkey.
A stationary display is obtained for the FM AF signal

Result (-10 ± 5) dB; this means that a deviation of 100 kHz is obtained if the demodulator characteristic slope is 5 dB/100 kHz

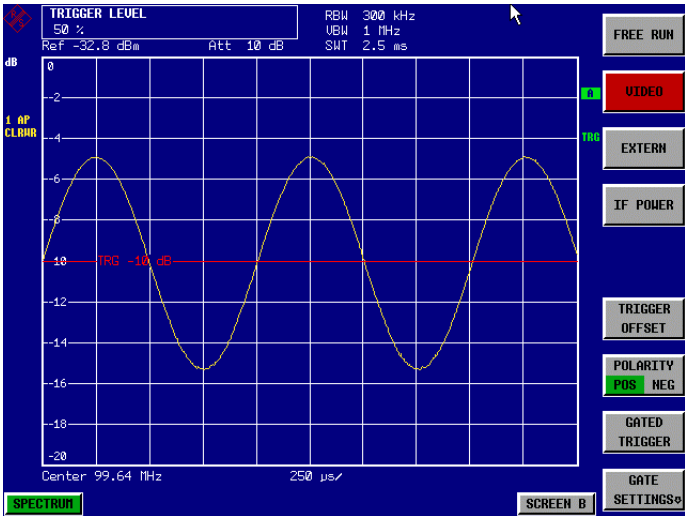

Fig. 2-33 Demodulated FM signal

Measuring Channel Power and Adjacent Channel Power

Measuring channel power and adjacent channel power is one of the most important tasks in the field of digital transmission for a spectrum analyzer with the necessary test routines. While, theoretically, channel power could be measured at highest accuracy with a power meter, its low selectivity means that it is not suitable for measuring adjacent channel power as an absolute value or relative to the transmit channel power. The power in the adjacent channels can only be measured with a selective power meter.

A spectrum analyzer cannot be classified as a true power meter, because it displays the IF envelope voltage. However, it is calibrated such as to correctly display the power of a pure sinewave signal irrespective of the selected detector. This calibration is not valid for non-sinusoidal signals. Assuming that the digitally modulated signal has a Gaussian amplitude distribution, the signal power within the selected resolution bandwidth can be obtained using correction factors. These correction factors are normally used by the spectrum analyzer's internal power measurement routines in order to determine the signal power from IF envelope measurements. These factors are valid if and only if the assumption of a Gaussian amplitude distribution is correct.

Apart from this common method, the FSP also has a true power detector, i.e. an RMS detector. It correctly displays the power of the test signal within the selected resolution bandwidth irrespective of the amplitude distribution, without additional correction factors being required. With an absolute measurement uncertainty of < 0.5 dB and a relative measurement uncertainty of < 0.2 dB (each with a confidence level of 95%), the FSP comes close to being a true power meter.

There are two possible methods for measuring channel and adjacent channel power with a spectrum analyzer:

The IBW method (**I**ntegration **B**andwidth **M**ethod) in which the spectrum analyzer measures with a resolution bandwidth that is less than the channel bandwidth and integrates the level values of the trace versus the channel bandwidth. This method is described in the section on noise measurements.

Measurement using a channel filter.

In this case, the spectrum analyzer makes measurements in the time domain using an IF filter that corresponds to the channel bandwidth. The power is measured at the output of the IF filter. Until now, this method has not been used for spectrum analyzers, because channel filters were not available and the resolution bandwidths, optimized for the sweep, did not have a sufficient selectivity. The method was reserved for special receivers optimized for a particular transmission method.

The FSP has test routines for simple channel and adjacent channel power measurements. These routines give quick results without any complex or tedious setting procedures.

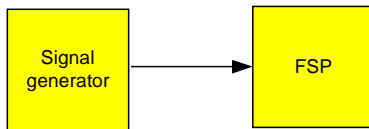
Measurement Example 1 - ACPR measurement on an IS95 CDMA Signal**Test setup:**

Settings on the signal generator (e.g. R&S SMIQ):

Frequency: 850 MHz
Level: 0 dBm
Modulation: CDMA IS 95

Measurement with the FSP:**1. Set the spectrum analyzer to its default state.**

- Press the *PRESET* key.
The FSP is in its default state.

2. Set the center frequency to 850 MHz and frequency deviation to 4 MHz.

- Press the *FREQ* key and enter *850 MHz*.

3. Set the reference level to +10 dBm.

- Press the *AMPT* key and enter *10 dBm*.

4. Configuring the adjacent channel power for the CDMA IS95 reverse link.

- Press the *MEAS* key.
- Press the *CHAN PWR ACP* ↕ softkey.
- Press the *CP/ACP STANDARD* softkey.

From the list of standards, select *CDMA IS95A REV* using the spinwheel or the cursor down key below the spinwheel and press *ENTER*.

The FSP sets the channel configuration according to the IS95 standard for mobile stations with 2 adjacent channels above and below the transmit channel. The spectrum is displayed in the upper part of the screen, the numeric values of the results and the channel configuration in the lower part of the screen. The various channels are represented by vertical lines on the graph.

The frequency span, resolution bandwidth, video bandwidth and detector are selected automatically to give correct results. To obtain stable results - especially in the adjacent channels (30 kHz bandwidth) which are narrow in comparison with the transmission channel bandwidth (1.23 MHz) - the RMS detector is used.

5. Set the optimal reference level and RF attenuation for the applied signal level.

- Press the *ADJUST REF LVL* softkey.

The FSP sets the optimal RF attenuation and the reference level based on the transmission channel power to obtain the maximum dynamic range. The following figure shows the result of the measurement.



Fig. 2-34 Adjacent channel power measurement on a CDMA IS95 signal

The repeatability of the results, especially in the narrow adjacent channels, strongly depends on the measurement time since the dwell time within the 30 kHz channels is only a fraction of the complete sweep time. A longer sweep time may increase the probability that the measured value converges to the true value of the adjacent channel power, but this increases measurement time.

To avoid long measurement times, the FSP measures the adjacent channel power in the time domain (FAST ACP). In the FAST ACP mode, the FSP measures the power of each channel at the defined channel bandwidth, while being tuned to the center frequency of the channel in question. The digital implementation of the resolution bandwidths makes it possible to select a filter characteristics that is precisely tailored to the signal. In case of CDMA IS95, the power in the useful channel is measured with a bandwidth of 1.23 MHz and that of the adjacent channels with a bandwidth of 30 kHz. Therefore the FSP jumps from one channel to the other and measures the power at a bandwidth of 1.23 MHz or 30 kHz using the RMS detector. The measurement time per channel is set with the sweep time. It is equal to the selected measurement time divided by the selected number of channels. The five channels from the above example and the sweep time of 100 ms give a measurement time per channel of 20 ms.

Compared to the measurement time per channel given by the span ($= 5$ MHz) and sweep time ($= 100$ ms, equal to 1.66 ms per 30 kHz channel) used in the example, this is a far longer dwell time on the adjacent channels (factor of 12). In terms of the number of uncorrelated samples this means $20000/33 \mu\text{s} = 606$ samples per channel measurement compared to $1667/33 \mu\text{s} = 50.5$ samples per channel measurement.

Repeatability with a confidence level of 95% is increased from ± 1.4 dB to ± 0.38 dB as shown in Fig. 2-28. For the same repeatability, the sweep time would have to be set to 1.2 s with the integration method. The following figure shows the standard deviation of the results as a function of the sweep time.

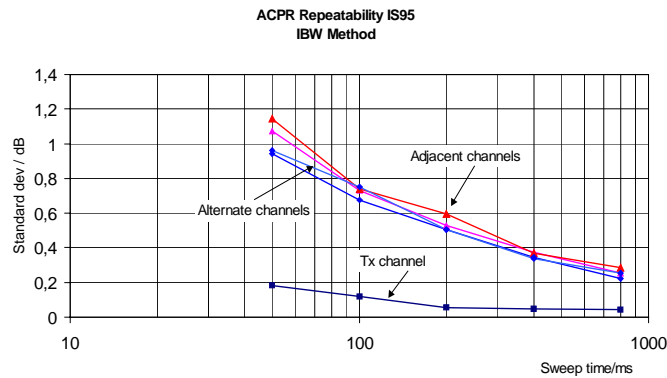

Fig. 2-35 Repeatability of adjacent channel power measurement on IS95-standard signals if the integration bandwidth method is used

6. Switch to Fast ACP to increase the repeatability of results.

➤ Press the *CP/ACP CONFIG* ↵ softkey.

➤ Set the *FAST ACP* softkey to *ON*.

The FSP measures the power of each channel in the time domain. The trace represents power as a function of time for each channel (see Fig. 2-36). The numerical results over consecutive measurements become much more stable.

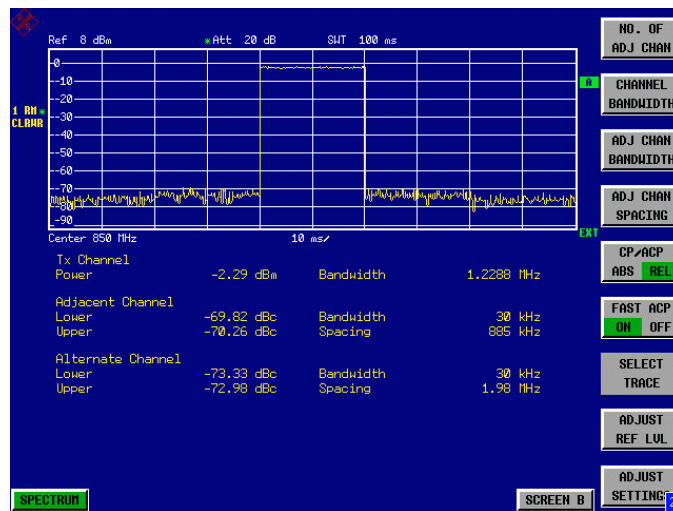

Fig. 2-36 Measuring the channel power and adjacent channel power ratio for IS95 signals in the time domain (Fast ACP)

The following figure shows the repeatability of power measurements in the transmit channel and of relative power measurements in the adjacent channels as a function of sweep time. The standard deviation of measurement results is calculated from 100 consecutive measurements as shown in Fig. 2-35. Take scaling into account if comparing power values.

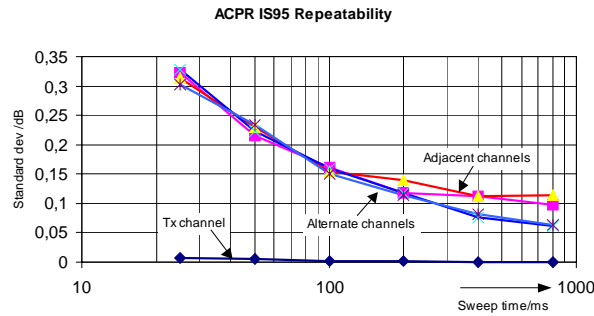

Fig. 2-37 Repeatability of adjacent channel power measurements on IS95 signals in the Fast ACP mode

Note on adjacent channel power measurements on IS95 base-station signals:

When measuring the adjacent channel power of IS95 base-station signals, the frequency spacing of the adjacent channel to the nominal transmit channel is specified as ± 750 kHz. The adjacent channels are, therefore, so close to the transmit channel that the power of the transmit signal leaks across and is also measured in the adjacent channel if the usual method using the 30 kHz resolution bandwidth is applied. The reason is the low selectivity of the 30 kHz resolution filter. The resolution bandwidth, therefore, must be reduced considerably, e.g. to 3 kHz to avoid this. This causes very long measurement times (factor of 100 between a 30 kHz and 3 kHz resolution bandwidth).

This effect is avoided with the time domain method which uses steep IF filters. The 30 kHz channel filter implemented in the FSP has a very high selectivity so that even with a ± 750 kHz spacing to the transmit channel the power of the useful modulation spectrum is not measured.

The following figure shows the passband characteristics of the 30 kHz channel filter in the FSP.

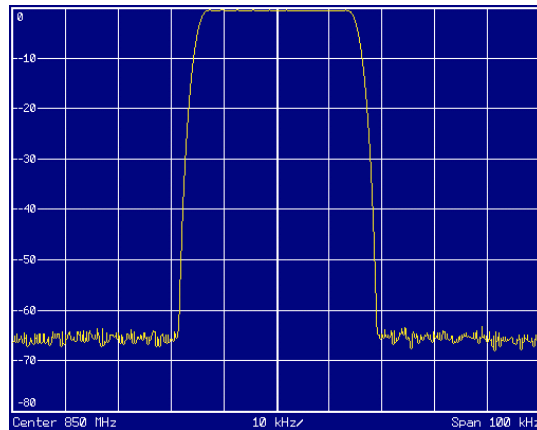
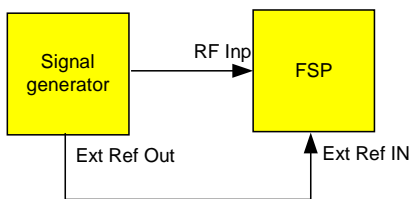

Fig. 2-38 Frequency response of the 30 kHz channel filter for measuring the power in the IS 95 adjacent channel

Measurement Example 2 – Measuring the adjacent channel power of an IS136 TDMA signal

Test setup:



Note: As the modulation spectrum of the IS136 signal leaks into the adjacent channel, it makes a contribution to the power in the adjacent channel. Exact tuning of the spectrum analyzer to the transmit frequency is therefore critical. If tuning is not precise, the adjacent channel power ratios in the lower and upper adjacent channels become asymmetrical. The FSP's frequency and the generator frequency are therefore synchronized.

Settings on the signal generator (e.g. R&S SMIQ):

Frequency: 850 MHz

Level: -20 dBm

Modulation: IS136/NADC

Measurement with the FSP

1. Set the spectrum analyzer to its default state.

- Press the *PRESET* key.
The FSP is in its default state.

2. Set up the FSP for synchronization to an external reference frequency.

- Press the *SETUP* key.
- Set the *REFERENCE* softkey to *EXT*.

3. Set the center frequency to 850 MHz-

Press the *FREQ* key and enter 850 MHz.

4. Configure adjacent channel power measurement for IS136 signals.

- Press the *MEAS* key.
- Press the *CHAN PWR ACP* ↕ softkey.
- Press the *CP/ACP STANDARD* softkey.
- Select *NADC IS136* from the list of standards and press *ENTER*.
The FSP performs the power measurement in 5 channels (in the useful channel and in the two upper and two lower adjacent channels).

5. Setting the optimum reference level and RF attenuation for the measurement

- Press the *ADJUST REF LEVEL* softkey.
The FSP sets the optimum RF attenuation and the optimum reference level on the basis of the measured channel power.

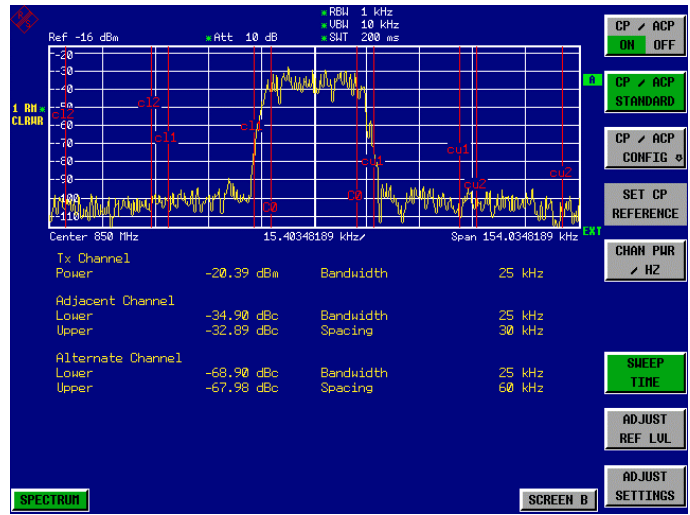

Fig. 2-39 Measuring the relative adjacent channel power of an NADC signal in each of the two adjacent channels below and above the transmit channel.

To increase repeatability - especially in the adjacent channels - the FSP's Fast ACP routine is recommended.

6. Switching on the Fast ACP routine.

- Press the *CP/ACP CONFIG* ↕ softkey
- Set the *FAST ACP* softkey to *ON*.
The FSP makes consecutive measurements on the 5 channels in the Zero Span mode using the receive filter specified in IS 136 to define the resolution bandwidth. The power in each channel is displayed on the graph as a function of time

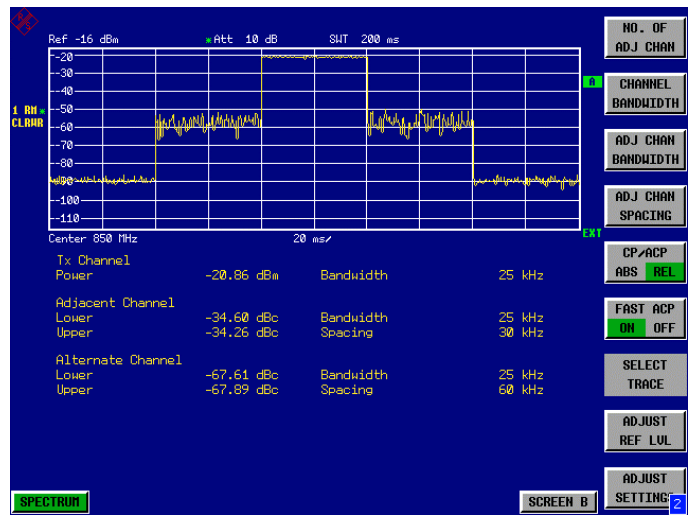

Fig. 2-40 Measuring adjacent channel power in time domain (Fast ACP)

As the resolution bandwidth is much wider than the one used for the integration method, the results are much more stable when compared at the same sweep time.

Repeatability can be influenced by the selected sweep time. The results become much more stable if long sweep times are selected. Since the amplitude distribution is different in different channels (part of the modulation spectrum falls within the first adjacent channel), the repeatability depends on the spacing of the measured channel from the transmit channel.

Fig. 2-41 below shows the standard deviation of results in the different channels as a function of the selected sweep time. The standard deviation for the various sweep times was recorded using a signal generator as a source. With real DUTs the amplitude distributions in adjacent channels may be different so that the standard deviation could differ from that shown in Fig. 2-41. To evaluate the correct measuring time for time-critical measurements at a given standard deviation, the standard deviation of the ACP values at the output of the real DUT must be determined.

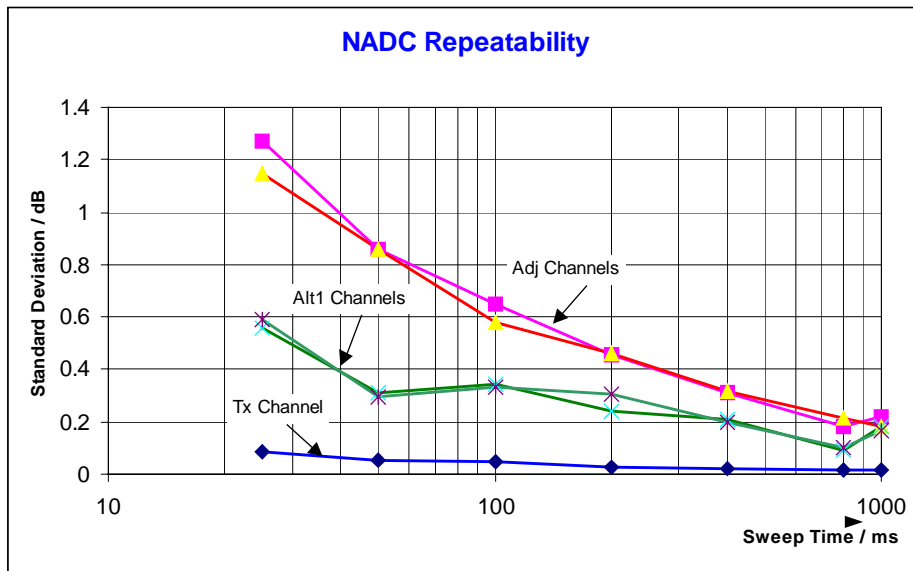

Fig. 2-41 Standard deviation of the results of Fast ACP measurement as a function of selected sweep time evaluated from 100 measurements per sweep time

Measurement Example 3 - Measuring the Modulation Spectrum in Burst Mode with the Gated Sweep Function

Since transmission systems compliant to IS136 use a TDMA method, the adjacent channel power must also be measured in burst mode. An IS136 TDMA frame is divided into 6 time slots. Two of these slots are assigned to a subscriber. This means that the ratio of transmit time to off-time for IS136 mobile phones is only 1:3 (e.g. time slots 1 and 4)

The FSP supports the measurement of the adjacent channel power in the TDMA mode with the Gated Sweep function.

Test setup with the R&S Signal Generator SMIQ:

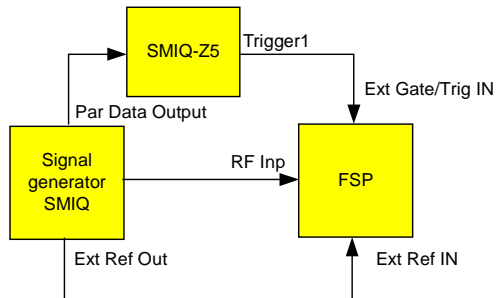

The SMIQ has to be equipped with options SMIQ-B10 or SMIQ-B20 (modulation coder) and SMIQ-B11 (data generator).

Option SMIQ-Z5 is required to trigger the FSP. This option is connected to the SMIQ's parallel output port. The BNC output Trigger 1 of the SMIQ-Z5 provides a TTL trigger signal on the rising edge of the IS136 burst, which is used to start the FSP sweep in the Gated Sweep mode.

Note: The FSP's IF power trigger is not suitable for IS136. It triggers on every level edge of the input signal. Since the modulation of the IS136 signal causes level dips even during the transmit burst, there is no way of ensuring that the FSP is only triggered on the burst edge.

Settings on signal generator SMIQ:

Switch the signal generator to the IS136 burst mode (time slots 1 and 4 are switched on, the other time slots are switched off).

The SMIQ is set as follows to generate the signal :

- Press the *PRESET* key.
- Press the *FREQ* key and enter 850 MHz.
- Press the *LEVEL* key and enter -20 dBm.
- Press the *RETURN* key.
- Select *DIGITAL STANDARD* using the spinwheel and press the *SELECT* key.
- Select *NADC* using the spinwheel and press the *SELECT* key.
- Press the *SELECT* key.
- Select *ON* using the spinwheel and press the *SELECT* key.
- Press the *RETURN* key.
- Keep turning the spinwheel until *SAVE/RECALL FRAME* appears in the list and select the menu item *SAVE/RECALL FRAME* using the *SELECT* key.
- The cursor is set to *GET PREDEFINED FRAME*.
- Press the *SELECT* key.

- Select *UP1TCH* using the spinwheel and press the *SELECT* key.

In the following operating sequence for the FSP, it is assumed that steps 1 to 6 of the previous example (example no. 2) have already been performed.

1. Configuring the Gated Sweep function on the FSP.

- Press the *TRIG* key.
- Press the *GATED TRIGGER* softkey.
- Press the *EXTERN* softkey.
- Press the *GATE SETTINGS* ∇ softkey.
The FSP switches to time domain measurement so that the setting of the Gated Sweep parameters can be checked visually.
- Press the *ZOOM X-AXIS* softkey and enter *10 ms*.
Exactly one TDMA burst will be displayed.
- Press the *GATE DELAY* softkey and enter *2 ms* or set the Gate Delay using the spinwheel so that the burst is reliably detected.
- Press the *GATE LENGTH* softkey and enter *5 ms* or set the vertical line for the gate length using the spinwheel so that the burst is reliably detected.

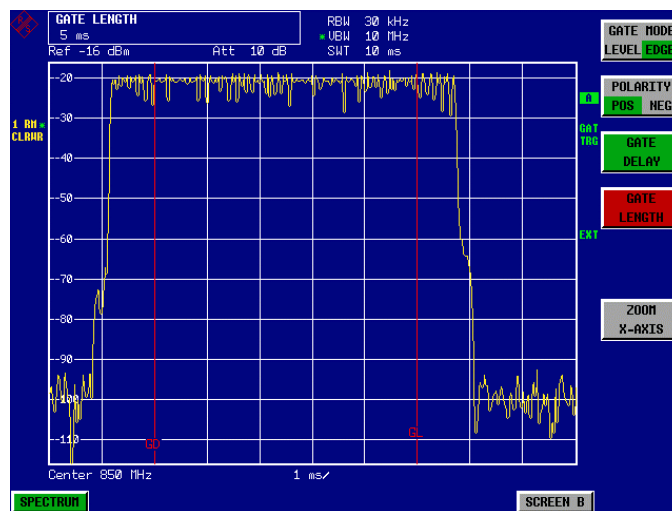

Fig. 2-42 Setting the parameters Gate Delay and Gate Length in time domain. The time interval required to measure the spectrum is indicated by two vertical lines.

- Press the *PREV* key.
The FSP now performs the ACP measurement only during the switch-on phase of the TDMA burst. The measurement is stopped during the switch-off phase.

Note: *The selected sweep time is the net sweep time, i.e. the time during which the FSP is actually measuring. The complete frame of an IS136 signal takes 40 ms. In the above example, measurement only takes place for 2x5 ms within a frame. The FSP is therefore only measuring for 25 % of the frame duration. The total measuring time is therefore four times that for the CW mode.*

Measurement Example 4 - Measuring the Transient Spectrum in Burst Mode with the Fast ACP function

In addition to the modulation spectrum or adjacent channel power from the modulation of the RF carrier, the spectrum or adjacent channel power generated by burst edges is also to be measured in TDMA systems. The spectrum is a pulse spectrum and must be measured with the peak detector. With the usual IBW method, only the power of the continuously modulated signal can be measured properly. Even if the modulation spectrum is transmitted in the TDMA mode, the measurement of the modulation spectrum will work because the burst edges are blanked out for the measurement by means of the Gated Sweep function. The spectrum analyzer performs measurements only if the modulation spectrum is continuous when the burst is on.

However, the IBW method fails for the spectrum created by the burst edges. As the measurement is carried out with resolution bandwidths that are very small compared to the signal bandwidth, a spurious amplitude distribution is obtained in the defined measurement channel because of the resolution bandwidth. The small resolution bandwidth cannot settle to the peak amplitudes of the test signal. This problem is avoided in the FSP by performing time domain measurements with the root raised cosine filter specified in the IS136 standard.

If the peak detector is used instead of the default RMS detector (which is selected when the standard is selected), the true adjacent channel power generated by the burst edges can also be measured.

Test setup: The test setup for this example and the settings for SMIQ are identical to those in the previous example.

Measurement with the FSP:

1. Set the spectrum analyzer to its default state.

- Press the *PRESET* key.
The FSP is in its default state.

2. Synchronize the FSP to an external reference frequency.

- Press the *SETUP* key.
- Set the *REFERENCE* softkey to *EXT*.

3. Set the center frequency to 850 MHz

- Press the *FREQ* key and enter 850 MHz.

4. Configure the adjacent channel power measurement for IS136 signals in Fast ACP mode.

- Press the *MEAS* key.
- Press the *CHAN PWR ACP* ↕ softkey.
- Press the *CP/ACP STANDARD* softkey.
- Select *NADC IS136* from the list of standards and press *ENTER*.
- Press the *CP/ACP CONFIG* ↕ softkey.
- Set the *FAST ACP* softkey to *ON*.
The FSP performs the power measurement in 5 channels (in the useful channel and in the two upper and lower adjacent channels).

5. Set the optimum reference level and RF attenuation for the measurement.

- Press the *ADJUST REF LEVEL* softkey.
The FSP sets the optimum RF attenuation and the optimum reference level on the basis of the measured channel power.

6. Select the peak detector and increase the sweep time to 10 s.

- Press the *TRACE* key.
- Press the *DETECTOR* softkey.
- Press the *PEAK* softkey.
- Press the *SWEEP* key.
- Press the *SWEEP TIME* softkey and enter 10 s.
The FSP measures the adjacent channel power generated by the burst edges and the modulation.

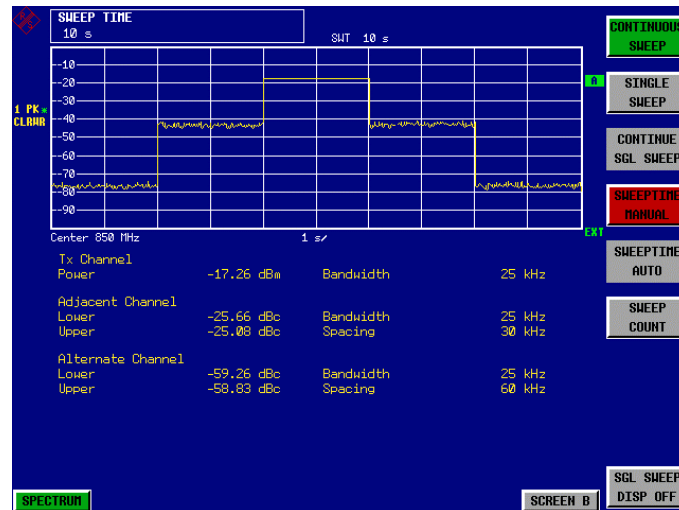
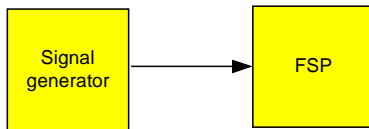

Fig. 2-43 Adjacent channel power due to modulation spectrum and transient spectrum

Note: The peak power display depends on the selected sweep time. The longer the sweep time, the higher the probability of measuring the highest peak amplitude of the signal. With shorter sweep times, level dips can be seen in the time domain traces. These level dips come from the burst characteristics of the signal. The numerical results, however, indicate the peak amplitudes during the measurement in the corresponding channel.

Measurement Example 5 - Measuring adjacent channel power of a W-CDMA uplink signal

Test setup:



Settings on the signal generator (e.g. R&S SMIQ):

Frequency: 1950 MHz
 Level: 4 dBm
 Modulation: 3 GPP W-CDMA Reverse Link

Measurement with the FSP:

1. Set the spectrum analyzer to its default state.

- Press the *PRESET* key.
The FSP is in its default state.

2. Set the center frequency to 1950 MHz.

- Press the *FREQ* key and enter *1950 MHz*.

3. Switch on the ACP measurement for W-CDMA.

- Press the *MEAS* key.
- Press the *CHAN PWR ACP* ↵ softkey.
- Press the *CP/ACP STANDARD* softkey.
- From the list of standards, select *W-CDMA 3GPP REV* using the spinwheel or the cursor down key below the spinwheel and press *ENTER*.
The FSP sets the channel configuration to the 3GPP W-CDMA standard for mobiles with two adjacent channels above and below the transmit channel. The frequency span, the resolution and video bandwidth and the detector are automatically set to the correct values. The spectrum is displayed in the upper part of the screen and the channel power, the level ratios of the adjacent channel powers and the channel configuration in the lower part of the screen. The individual channels are displayed as vertical lines on the graph.

4. Set the optimum reference level and the RF attenuation for the applied signal level.

- Press the *ADJUST REF LEVEL* softkey.
The FSP sets the optimum RF attenuation and the reference level for the power in the transmission channel to obtain the maximum dynamic range. The following figure shows the result of the measurement:

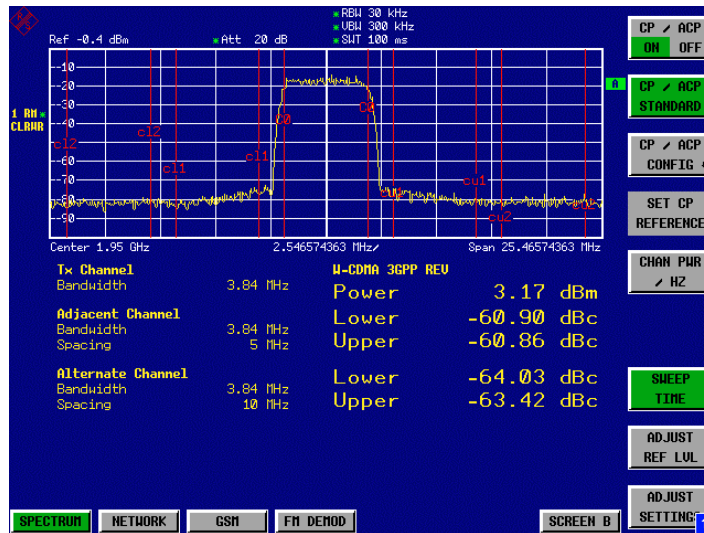

Fig. 2-44 Measuring the relative adjacent channel power on a W-CDMA uplink signal

5. Measuring adjacent channel power with the Fast ACP method.

- Press the CP/ACP CONFIG ↕ softkey.
- Set FAST ACP softkey to ON.
- Press the ADJUST REF LVL softkey.
The FSP measures the power of the individual channels in the time domain. A root raised cosine filter with the parameters $\alpha = 0.22$ and chip rate 3.84 Mcps (= receive filter for 3GPP W-CDMA) is used as the channel filter.

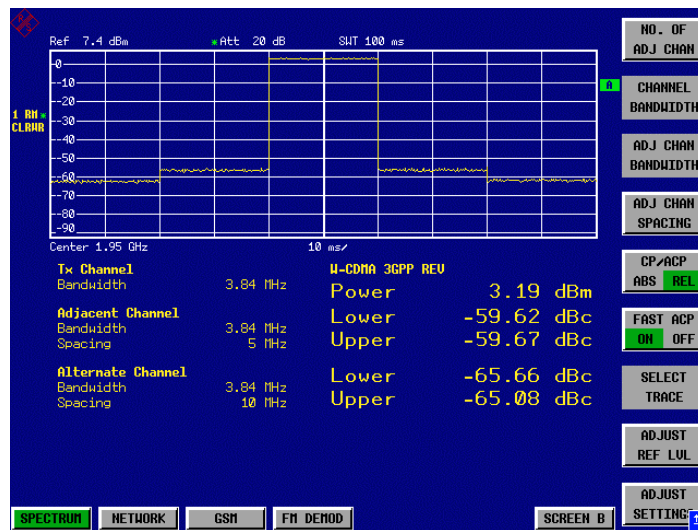

Fig. 2-45 Measuring the adjacent channel power of a W-CDMA signal with the Fast ACP method

Note: With W-CDMA, the FSP's dynamic range for adjacent channel measurements is limited by the 12-bit A/D converter. The greatest dynamic range is, therefore, obtained with the IBW method.

Optimum Level Setting for ACP Measurements on W-CDMA Signals

The dynamic range for ACPR measurements is limited by the thermal noise floor, the phase noise and the intermodulation (spectral regrowth) of the spectrum analyzer. The power values produced by the FSP due to these factors accumulate linearly. They depend on the applied level at the input mixer. The three factors are shown in the figure below for the adjacent channel (5 MHz carrier offset)

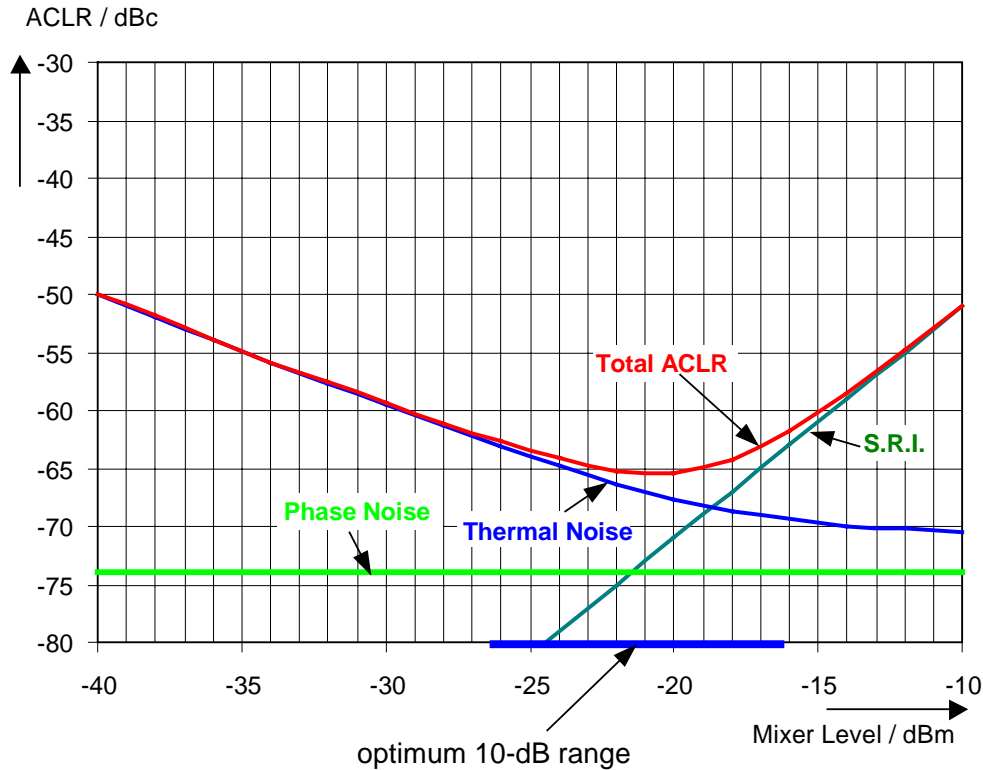

Fig. 2-46 The FSP's dynamic range for adjacent channel power measurements on W-CDMA uplink signals is a function of the mixer level.

The level of the W-CDMA signal at the input mixer is shown on the horizontal axis, i.e. the measured signal level minus the selected RF attenuation. The individual components which contribute to the power in the adjacent channel and the resulting relative level (total ACPR) in the adjacent channel are displayed on the vertical axis. The optimum mixer level is -21 dBm. The relative adjacent channel power (ACPR) at an optimum mixer level is -65 dBc. Since, at a given signal level, the mixer level is set in 10 dB steps with the 10 dB RF attenuator, the optimum 10 dB range is shown in the figure: it spreads from -16 dBm to -26 dBm. The obtainable dynamic range in this range is 62 dB.

To set the attenuation parameter manually, the following method is recommended:

- Set the RF attenuation so that the mixer level (= measured channel power – RF attenuation) is between -11 dBm and -21 dBm.
- Set the reference level to the largest possible value where no overload (IFOVLD) is indicated.

This method is automated with the FSP's ADJUST REF LEVEL function. Especially in remote control mode, e.g. in production environments, it is best to correctly set the attenuation parameters prior to the measurement, as the time required for automatic setting can be saved.

Note: To measure the FSP's intrinsic dynamic range for W-CDMA adjacent channel power measurements, a filter which suppresses the adjacent channel power is required at the output of the transmitter. A SAW filter with a bandwidth of 4 MHz, for example, can be used.

Amplitude distribution measurements

If modulation types that do not have a constant envelope in the time domain are used, the transmitter has to handle peak amplitudes that are greater than the average power. This includes all modulation types that involve amplitude modulation -QPSK for example. CDMA transmission modes in particular may have power peaks that are large compared to the average power.

For signals of this kind, the transmitter must provide large reserves for the peak power to prevent signal compression and thus an increase of the bit error rate at the receiver.

The peak power, or the crest factor of a signal is therefore an important transmitter design criterion. The crest factor is defined as the peak power / mean power ratio or, logarithmically, as the peak level minus the average level of the signal.

To reduce power consumption and cut costs, transmitters are not designed for the largest power that could ever occur, but for a power that has a specified probability of being exceeded (e.g. 0.01%).

To measure the amplitude distribution, the FSP has simple measurement functions to determine both the APD¹ = Amplitude Probability Distribution and CCDF = Complementary Cumulative Distribution Function.

In the APD display mode, the probability of occurrence of a certain level is plotted against the level. In the CCDF display mode, the probability that the mean signal power will be exceeded is shown in percent.

Measurement Example – Measuring the APD and CCDF of white noise generated by the FSP

1. Set the spectrum analyzer to its default state.

- Press the *PRESET* key.
The FSP is in its default state.

2. Configure the FSP for APD measurement

- Press the *AMPT* key and enter *-60 dBm*.
The FSP's intrinsic noise is displayed at the top of the screen.
- Press the *MEAS* key.
- Press the *SIGNAL STATISTIC* ↵ softkey.
- Set the *APD* softkey to *ON*.
The FSP sets the frequency span to 0 Hz and measures the amplitude probability distribution (APD). The number of uncorrelated level measurements used for the measurement is 100000. The mean power and the peak power are displayed in dBm. The crest factor (peak power – mean power) is output as well (see Fig. 2-47).

¹ In the literature, APD is also used for the probability of amplitude violation. This is the complimentary function to the APD function of FSP. The term PDF (=Probability Density Function) which is frequently used in the literature corresponds to the APD function of FSP.

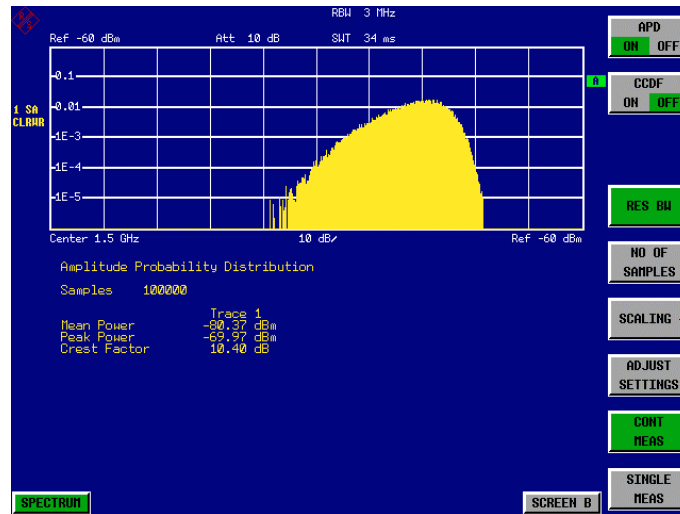

Fig. 2-47 Amplitude probability distribution of white noise

3. Switch to the CCDF display mode.

- Set the CCDF softkey to ON
The APD measurement is switched off and the CCDF display mode is switched on.

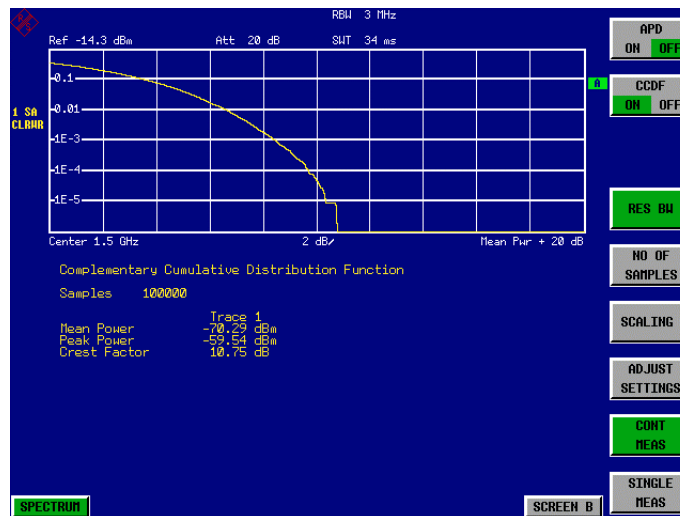

Fig. 2-48 The CCDF of white noise

The CCDF trace indicates the probability that a level will exceed the mean power. The level above the mean power is plotted along the X axis of the graph. The origin of the axis corresponds to the mean power level. The probability that a level will be exceeded is plotted along the Y axis.

4. Bandwidth selection

If the amplitude distribution is measured, the resolution bandwidth must be set in a way that the complete spectrum of the signal to be measured falls within the bandwidth. This is the only way of ensuring that all the amplitudes will pass through the IF filter without being distorted. If the selected resolution bandwidth is too small for a digitally modulated signal, the amplitude distribution at the output of the IF filter becomes a Gaussian distribution according to the central limit theorem and so corresponds to a white noise signal. The true amplitude distribution of the signal therefore cannot be determined.

A video bandwidth which is large in comparison to the resolution bandwidth ($\geq 3 \times \text{RBW}$) must be selected. This ensures that the amplitude peaks of the signal are not smoothed by the lowpass effect of the video filter. The video bandwidth is set automatically during statistics measurements.

Since the video bandwidth of the FSP is limited to 10 MHz, lowpass filtering occurs during measurements with a resolution bandwidth of 10 MHz. Additional band-limiting occurs at a resolution bandwidth of 10 MHz due to the lowpass filtering at the output of the log amplifier. The latter limits the video signal to a bandwidth of 8 MHz in order to obtain sufficient suppression of the 20.4 MHz IF. The level range of the signal amplitudes, e.g. during APD white-noise measurements, is smaller. For broadband-modulated signals such as W-CDMA signals, the effect depends on the bandwidth occupied by the signal. At a signal bandwidth of 4 MHz, the amplitude distribution can be measured correctly with the effective video bandwidth.

5. Selecting the number of samples

For statistics measurements with the FSP, the number of samples N_{Samples} is entered for statistical evaluation instead of the sweep time. Since only statistically independent samples contribute to statistics, the measurement or sweep time is calculated automatically. It is indicated on the FSP display. The samples are statistically independent if the time difference is at least $1/\text{RBW}$. The sweep time SWT is, therefore, expressed as follows:

$$\text{SWT} = N_{\text{Samples}} / \text{RBW}$$

Time Domain Measurements

With TDMA radiocommunication systems (e.g. GSM or IS136), the transmission quality is determined not only by the spectral characteristics, but also by the time domain characteristics. Since several users share the same frequency, a time slot is assigned to the each user. Unimpaired operation can only be ensured if each user adheres to his assigned time slot.

In this case, both the power during the transmit phase and the time characteristics such as duration of the TDMA burst as well as rise and fall time of the burst are relevant.

Power measurements

The FSP has easy-to-operate functions for measuring power during a given time interval.

Measurement Example – Measuring the power of a GSM burst during the switch-on phase

Test setup:

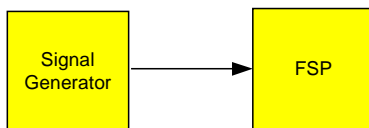

Settings on the signal generator (e.g. R&S SMIQ):

Frequency: 100 MHz
Level: 0 dBm
Modulation: GSM, one time slot is switched on

Measurement using the FSP:

- 1. Set the spectrum analyzer to its default state.**
 - Press the *PRESET* key.
The FSP is in its default state.
- 2. Set the center frequency to 100 MHz, the span to 0 Hz and the resolution bandwidth to 1 MHz.**
 - Press the *FREQ* key and enter *100 MHz*.
 - Press the *SPAN* key and enter *0 Hz* or press the *ZEROSPAN* softkey.
- 3. Set the FSP reference level to 10 dBm (= signal generator level +10 dB).**
 - Press the *AMPT* key and enter *10 dBm*.
- 4. Set the sweep time to 1 ms**
 - Press the *SWEEP* key and enter *1 ms*.
The FSP shows the GSM burst running across the display.

5. Trigger on the rising edge of the burst using the video trigger.

- Press the *TRIG* key.
- Press the *VIDEO* softkey and enter 70%.
The FSP displays a stable curve with the GSM burst at the beginning of the trace. The trigger level is shown as a horizontal line labeled with the absolute level for the trigger threshold.

6. Configure the power measurement in the time domain.

- Press the *MEAS* key.
- Press the *TIME DOM POWER* ↓ softkey.
- Set the *LIMITS* softkey to *ON*.
- Press the *START LIMIT* softkey.
- Place the vertical line on the start of the burst by turning the spinwheel clockwise.
- Press the *STOP LIMIT* softkey.
- Place the second vertical line on the end of the burst by turning the spinwheel counterclockwise.
The FSP displays the mean power during the switch-on phase of the burst (see Fig. 2-49).

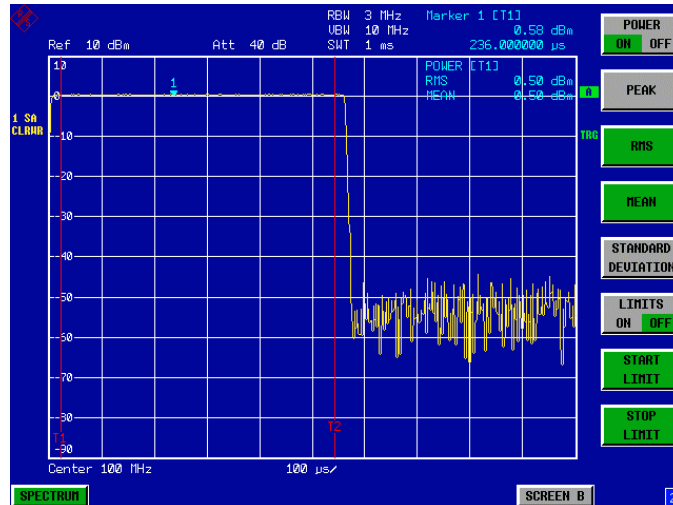

Fig. 2-49 Measuring mean power during the switch-on phase of a GSM burst

Power Ramping Measurement for Burst Signals

Since the FSP has a high time resolution at 0 Hz span, the edges of the TDMA burst can be measured accurately. The use of the trigger offset makes it possible to shift the edges onto the screen.

Measurement Example – Measurements on GSM burst edges using a high time resolution

Test setup:

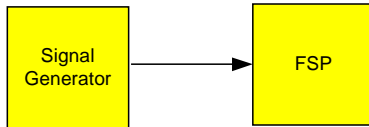

Settings on the signal generator (e.g. R&S SMIQ):

Frequency: 100 MHz

Level: 0 dBm

Modulation: GSM, one time slot is switched on

Measurement using the FSP

The settings of the example above are used to measure GSM burst power during the switch-on phase.

1. Switch off power measurement.

- Press the *MEAS* key.
- Press the *TIME DOM POWER* ↕ softkey.
- In the submenu, set the *POWER* softkey to *OFF*.

2. Increase the time resolution to 100 μs.

- Press the *SWEEP* key and enter 100 μs.

3. Shift the rising edge of the GSM burst to the middle of the screen using the trigger offset.

- Press the *TRIG* key.
- Press the *TRIGGER OFFSET* softkey.
- Set the trigger offset by turning the spinwheel (counterclockwise) until the burst edge is in the middle of the screen or enter -50 μs.
The FSP displays the rising edge of the GSM burst (see Fig. 2-50)

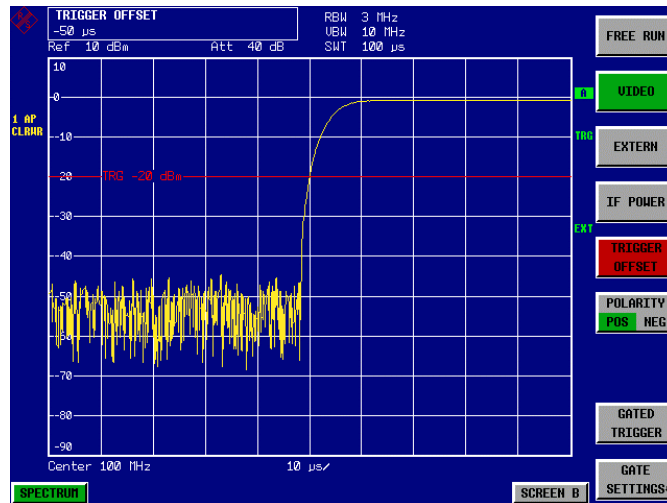

Fig. 2-50 Rising edge of GSM burst at high time-resolution.

4. **Shift the falling edge of burst to the middle of the screen using the trigger offset.**

- Set the *POLARITY* softkey to *NEG*.
The FSP displays the falling edge of the GSM burst (see Fig. 2-51)

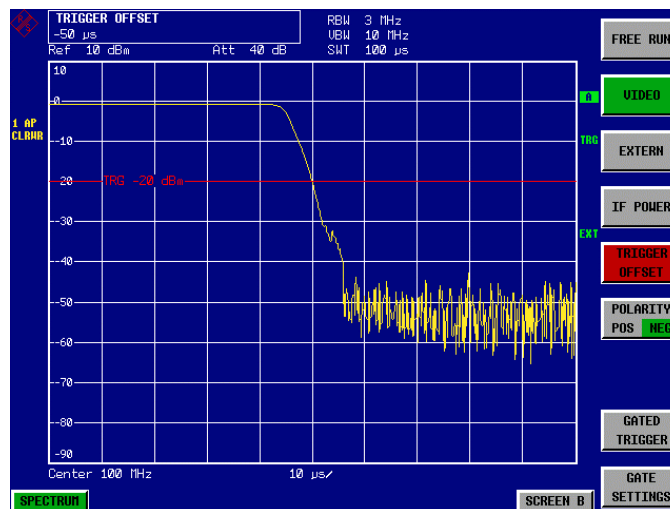

Fig. 2-51 Falling edge of GSM burst at high time resolution

Measuring the S/N Ratio of Burst Signals

For TDMA transmission methods, the S/N ratio or the switch-off range can be measured by comparing the powers during the switch-on and switch-off phase of the transmission burst. The FSP, therefore, has a function to perform absolute and relative power measurements in the time domain. The measurement is carried out as follows, using a GSM burst as an example.

Measurement Example - S/N ratio of a GSM signal

Test setup:

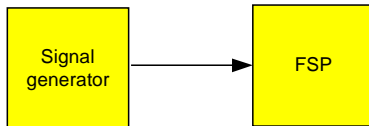

Settings on the signal generator (e.g. R&S SMIQ):

Frequency: 100 MHz

Level: 0 dBm

Modulation: GSM, one time slot is switched on

Measurement using the FSP

1. Set the spectrum analyzer to its default state.

- Press the *PRESET* key.
The FSP is in its default state.

2. Set the center frequency to 100 MHz, the span to 0 Hz and the resolution bandwidth to 1 MHz.

- Press the *FREQ* key and enter *100 MHz*.
- Press the *SPAN* key and enter *0 Hz*
or
- press the *ZEROSPAN* softkey.
- Press the *BW* key and enter *1 MHz*.

3. Set the reference level of the FSP to 0 dBm (= signal generator level) and the RF attenuation to 10 dB for maximum sensitivity.

- Press the *AMPT* key and enter *0 dBm*.
- Press the *RF ATTEN MANUAL* softkey and enter *10 dB*.

4. Set the sweep time to 2 ms.

- Press the *SWEEP* key and enter *2 ms*.
The FSP displays the GSM burst running across the display.

5. Trigger on the rising edge of the burst using the video trigger and shift beginning of burst to the middle of the screen.

- Press the TRIG key.
- Press the VIDEO softkey and enter 70%.
The FSP displays a stable image with the GSM burst at the start of the trace.
- Press the TRIGGER OFFSET softkey and enter -1 ms.
The FSP displays the GSM burst in the right half of the graph.

6. Configure the power measurement in the time domain.

- Press the MEAS key.
- Press the TIME DOM POWER \downarrow softkey.
- Set the LIMITS softkey to ON.
- Press the START LIMIT softkey.
- Place the vertical line on the start of the burst using the spinwheel.
- Press the STOP LIMIT softkey.
- Place the second vertical line on the end of the burst using the spinwheel. .
The FSP displays the power during the switch-on phase of the burst.

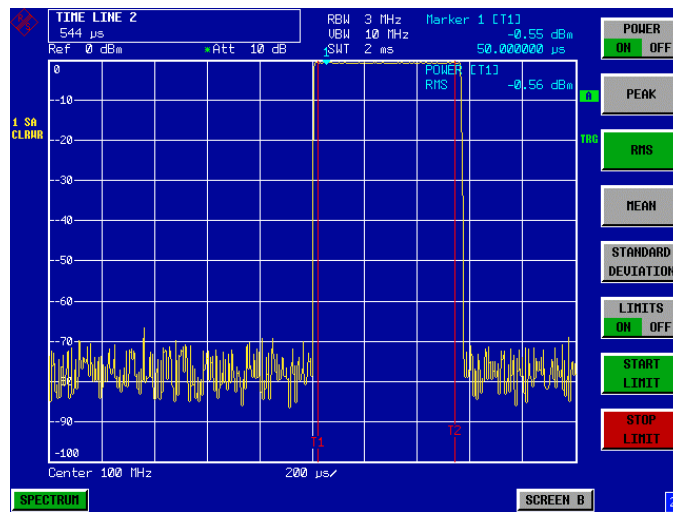

Fig. 2-52 Measuring power during the switch-on phase of the burst

7. Define the measured power as the reference and switch on relative power measurement.

- Press the NEXT key.
The side menu for setting the power measurement is opened.
- Set the POWER ABS/REL softkey to REL.
- The power relative to the power during the switch-on phase of the burst is displayed.
- Press the SET REFERENCE softkey.
The measured power of the GSM burst is defined as the reference.

8. Measure the power during the switch-off phase of the burst.

- Press the *TRIG* key.
- Set the *POLARITY POS/NEG* softkey to *NEG*.
The FSP triggers on the falling edge of the burst. The burst is then shifted to the left half of the screen. The power is measured in the switch-off phase. The start of the burst is shifted to the middle of the screen and the power is measured during the switch-off phase relative to the reference power (= burst power).

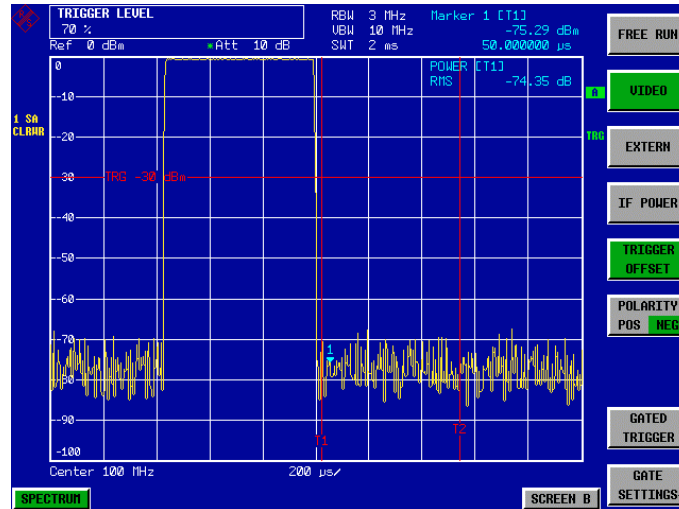

Fig. 2-53 Measuring the S/N ratio of the GSM burst signal in the time domain

Contents - Chapter 3 "Manual Operation"

3 Manual Operation	3.1
The Screen.....	3.1
Diagram Area	3.2
Indications in the Diagram Area	3.3
Full Screen	3.8
Split Screen	3.8
Softkey Area	3.9
Hotkey Area	3.10
Calling and Changing the Menus	3.10
Setting Parameters	3.11
Numeric Keypad	3.11
Spinwheel and Cursor Keys	3.12
Selection and Setting of Parameters via Keys or Softkeys.....	3.13
Editing of Numeric Parameters.....	3.16
Entry of Alphanumeric Parameter	3.19
Editing with External Keyboard.....	3.19
Editing with Help Line Editor.....	3.20
Selection and Setting of Parameters via Tables.....	3.23
Menu Overview	3.25
FREQUENCY Key	3.25
SPAN Key.....	3.26
AMPT Key.....	3.27
MKR Key.....	3.28
MKR-> Key	3.29
MKR FCTN Key	3.30
MEAS Key.....	3.31
BW Key.....	3.32
SWEEP Key.....	3.33
TRIG Key.....	3.34
TRACE Key	3.35
LINES Key	3.36
DISP Key	3.37
FILE Key	3.38
CAL Key.....	3.39
SETUP Key.....	3.40
HCOPY Key.....	3.41
Hotkey Menu.....	3.42
LOCAL Menu.....	3.42
Menu Overview Network Mode.....	3.43
Menu Overview Option Ext. Generator Control.....	3.44

3 Manual Operation

Chapter 3 provides an overview of the operating concept and the basic steps of manual operation of the FSP. This includes a description of the screen, of the control of menus and of the setting of parameters. An overview of the menus will be listed at the end of this chapter.

The functions of the menus are described in detail in Chapter 4. Chapter 2 contains a short introduction on step-by-step simple measurements. The remote control of the instrument is described in Chapters 5, 6 and 7

The operation of the spectrum analyzer is menu-controlled via keys, hotkeys and softkeys. The setting of the instrument and test parameters in the menu is made either directly via softkeys or by entry of values in entry fields and by selection in tables. The operating mode and the screen mode is selected via the hotkeys.

If required, data entry windows and tables are superimposed on the screen.

The Screen

The screen informs continuously on the results and parameters of the selected measuring functions. It shows the assignment of the softkeys and menus, which are required for setting the measuring parameters. The display of test results, the softkey labeling and the type of menu depend on the selected measuring function.

The screen is subdivided into three areas:

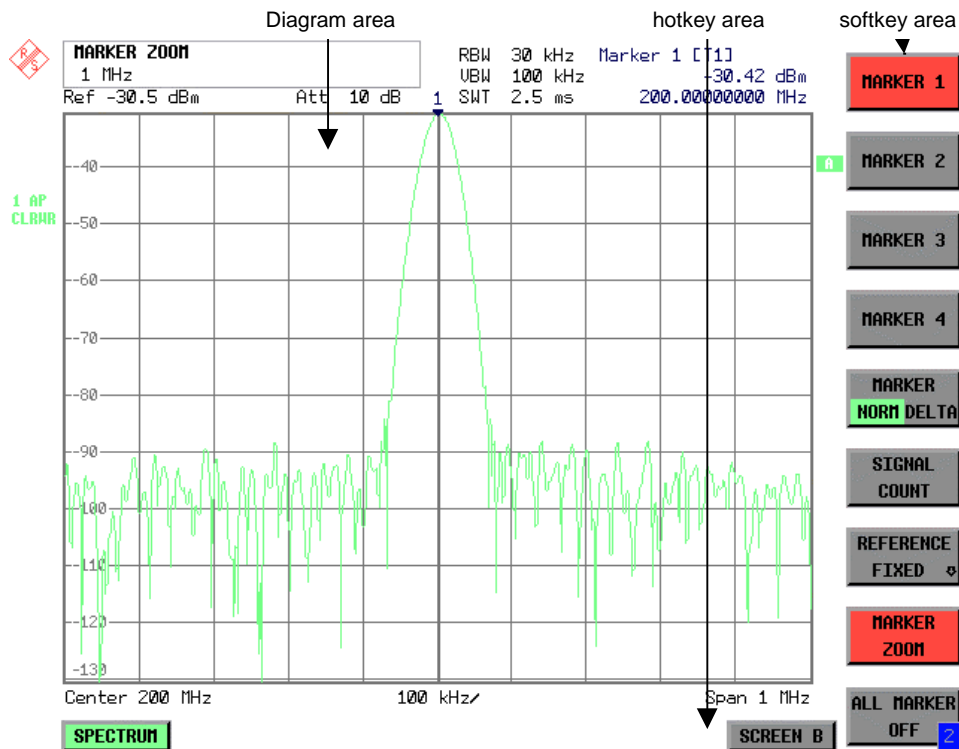

Fig. 3-1 Subdivision of screen

Diagram area This area contains the measuring diagrams and other measured-value information as well as the parameters and status information which are important for analysis of the results. In addition, message fields, entry windows and tables may be shown in this area.

Softkey area This area contains the instrument functions which can be selected via the softkeys. The softkey area is not superimposed by other graphics.

Hotkey area This area contains the available operating modes and screen modes. The hotkey area is not superimposed by other graphics.

Diagram Area

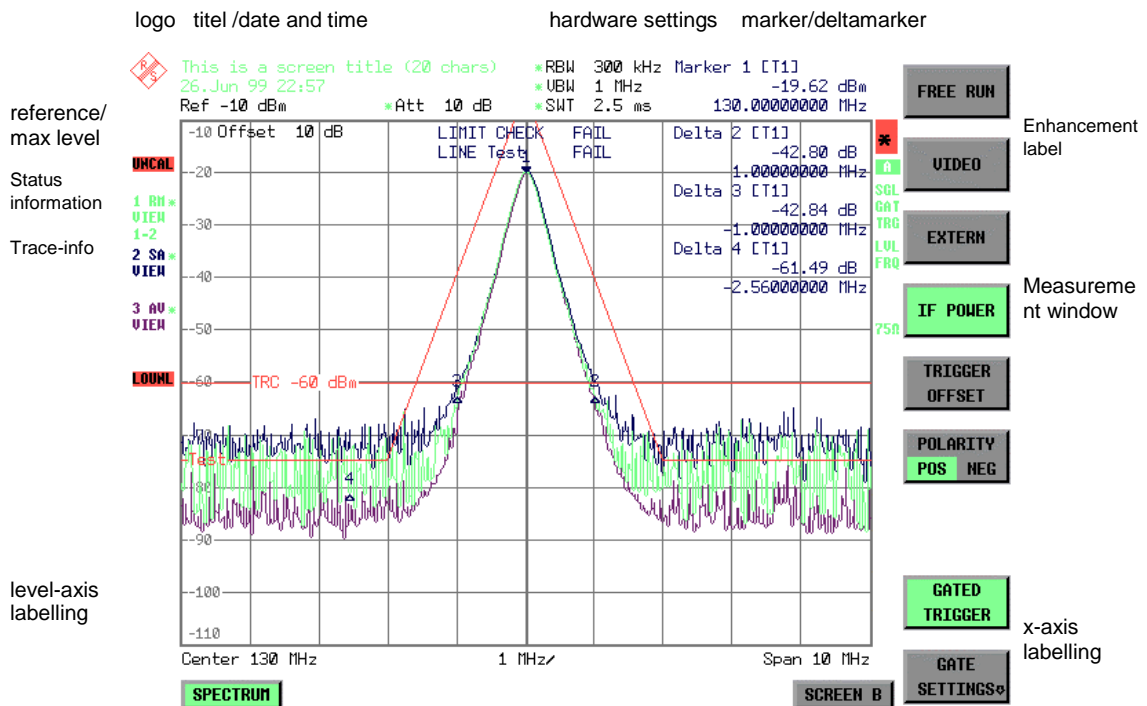

Fig. 3-2 Subdivision of the FSP screen in analyzer mode (without measuring diagram)

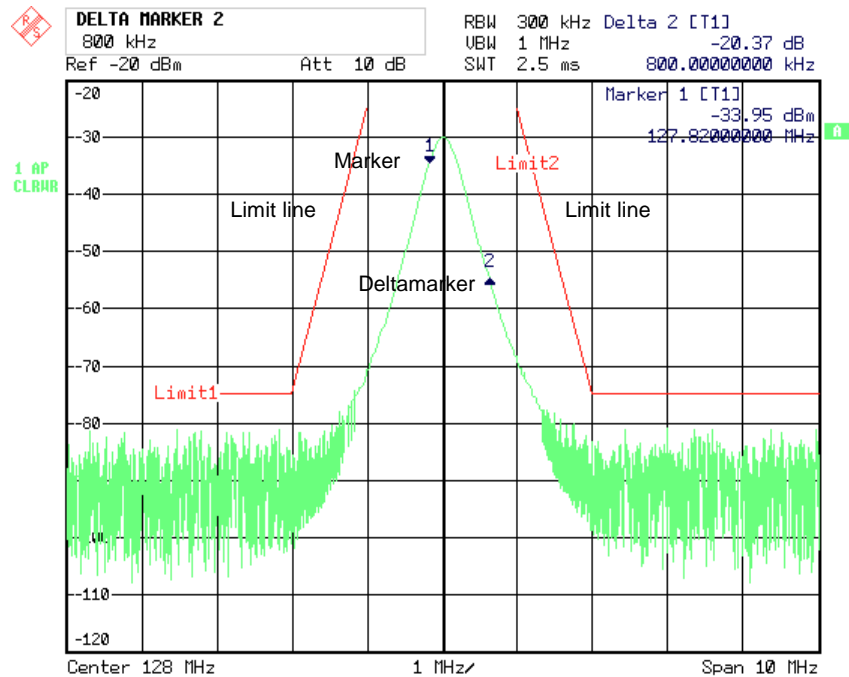

Fig. 3-3 Measuring diagram

Indications in the Diagram Area

The following graphic elements are displayed in the diagram area:

General indications	Indication of the logo
Logo	
Screen title	Indication of selected screen title
Date / time	Indication of date and time
Hardware settings	
Ref	Indication of the reference level
Offset	Indication of the offset of reference level.
Att	Indication of the set RF attenuation.
RBW	Indication of the set resolution bandwidth. If the bandwidth does not correspond to the value of the automatic coupling, a green asterisk "*" is prefixed to the field.
VBW	Indication of the set video bandwidth. If the bandwidth does not correspond to the value of the automatic coupling, a green asterisk "*" is prefixed to the field.
SWT	Indication of the set sweep time. If the sweep time does not correspond to the value of the automatic coupling an asterisk "*" is prefixed to the field. The colour of the asterisk turns red as soon as the sweep time falls below the value of the automatic coupling.

Marker/deltamarker This label displays the position of the last selected marker or deltamarker in the x and y-directions and the marker/deltamarker index. The square brackets contain the curve which the marker is assigned to and the active measuring function of the marker indicated. The measuring function of the markers in the second field is indicated by the following abbreviations:

FXD reference fixed active
 PHN phase noise measurement active
 CNT frequency counter active
 TRK signal track active
 NOI noise measurement active
 MOD measurement of AM modulation depth active
 TOI TOI measurement active (3rd order intercept)

Limit check Indication of the result of the limit check.

X-axis labelling Display of the x-scaling.

10 MHz/DIV

The distance between two grid lines is displayed in this label.

Center 1.2345678901234 GHz

The set center frequency or start frequency is displayed in this label depending on whether the keys FREQ/SPAN or the softkeys START/STOP were last pressed.

Start 1.2345678901234 GHz

If span = 0 Hz, the center frequency is always displayed.

Span 1.2345678901234 GHz

The set frequency range (SPAN) or the stop frequency is displayed, depending on whether the keys FREQ/SPAN or the softkeys START/STOP were last pressed.

Stop 1.2345678901234 GHz

If span = 0 Hz, the trigger moment (PRETRIGGER) is displayed.

Trigger 1.234 ms

Status information The status information on the left side of the diagram hint at irregularity (e.g. UNCAL)

#SMPL ⇒ reduce span or increase RBW

- UNCAL** "UNCAL" is indicated under the following circumstances:
- correction data are switched off (menu CAL, CAL CORR OFF).
 ⇒ switch on CAL CORR ON or PRESET
 - no valid correction data. This may occur after a cold start of the instrument following a firmware update.
 ⇒ record correction data
 - Sweep time too short for current instrument settings (span, resolution bandwidth, video bandwidth).
 ⇒ increase sweep time

OVLD / IFOVL	OVLD is indicated when the input mixer is overloaded. ⇒ Increase input attenuation IFOVL is indicated when overload occurs in the IF signal path after the input mixer. ⇒ Increase reference level
LOUNL / EXREF	LOUNL is indicated when an error occurs in the frequency processing of the instrument. EXREF is indicated when the analyzer is configured for use of an external reference signal, but no reference signal is detected at the corresponding input.
OVEN	OVEN is indicated when the crystal oscillator (option FSP-B4) has not yet reached its operating temperature. This indication vanishes after a few minutes after switch on.

Trace info:

Every active measurement curve (trace ≠ BLANK) is allocated trace information of two or three lines at the left of the diagram. The trace information has the same colour as the measurement curve. The information on the currently selected trace is displayed in inverse video (see *TRACE - SELECT TRACE softkey*).

**<n> <detector> <*>
<mode>
<trace math>**

n = trace number (1 ... 3)

detector = selected detector
AP: AUTOPEAK detector
PK: MAX PEAK detector
MI: MIN PEAK detector
SA: SAMPLE detector
AV: AVERAGE detector
RM: RMS detector
QP: QUASISPEAK detector

* = indicates that the selected detector does not correspond to that of the automatic coupling.

mode = indication of sweep mode
CLRWR: CLEAR/WRITE
MAXH: MAX HOLD
MINH: MIN HOLD
AVG: AVERAGE
VIEW: VIEW

Trace math = trace math active
1 - 2 trace 1 - trace 2
1 - 3: trace 1 - trace 3

Example:

1 PK *
CLRWR
1-2

Instrument settings
(Enhancement Labels)

Indication of user instrument settings which influence the measuring result and which are not immediately obvious when viewing the measured values.

- * The current instrument setting does not correspond to the one which applied when one of the displayed curves had been stored. This occurs under the following circumstances:
 - The instrument setting is modified while a measurement is being performed.
 - The instrument setting is modified in SINGLE SWEEP mode subsequent to the end of the sweep and no new sweep is started.
 - The instrument setting is modified after setting the trace to VIEW.

The display is retained until the cause is eliminated by the user. I.e., either a new sweep is started (SINGLE SWEEP mode), or the trace of interest is switched to BLANK.

A / B	Identification for screen A / B. When screen A / B is activated for the entry of test parameters, this label is highlighted.
SGL	The sweep is set to SINGLE SWEEP.
GAT	The frequency sweep is controlled via the <i>EXT TRIG/GATE</i> input of the instrument.
TRG	The instrument is not triggered in <i>FREE RUN</i> mode.
LVL	A level offset $\neq 0$ dB has been set.
FRQ	A frequency offset $\neq 0$ Hz has been set.
PRN	A printer output is active.
75 Ω	The input impedance of the instrument is set to 75 Ω .
EXT	The instrument is configured for operation with external reference
PA	The RF preamplification is switched on (option FSP-B25)

Entry fields:**Entry window**

The data entry window is superimposed in the left upper corner of the diagram area, if required. It covers the display of the title and the time. The field is used to enter numeric or alphanumeric device parameters.

Tables

The tables are superimposed in the diagram area, if required. They are used for displaying and configuring device parameters.

Message windows:**Message field**

Message fields provide notes on measurements, e.g. results of the limit check (PASS/FAIL). These notes are no error messages, which are indicated as system messages.

They can be masked out by pressing the *ESC* key.

System messages

System messages indicate warnings and error messages.

Message without action field:

These system messages contain only arbitrary information. They hint at events which are of interest for the user but do not affect the measurement or functioning of the instrument.

They are deleted either automatically after a predefined time has passed (3 seconds) or upon any keystroke or mouse click.

Message with action field:

These system messages require a decision to be taken by the user. They are not deleted until any action has been selected. Deletion of the message initiates the action selected and appropriate measures to be taken. The action field consists of one (OK), two (OK/CANCEL) or three (arbitrary) buttons.

The user may select one of the buttons using the cursor keys and initiate the associated action by means of the unit keys. The *ESC* key is used to acknowledge the message without releasing any action.

Traces:**1 to 3**

Up to 3 traces in each measurement diagram can be displayed simultaneously.

Limit lines

Limit lines are used to mark level curves or spectral distributions which must not be exceeded or dropped below.

The FSP provides two display modes:

- Full Screen: 1 window, the measurement is performed in the active diagram.
- Split Screen: 2 windows, the measurements are performed in both diagrams.

Full Screen

In the full-screen mode, the settings and measurements are performed in the active visible window. All indications on the screen refer to this window. The designation (SCREEN A or SCREEN B) is inserted as enhancement label A or B on the right diagram margin.

Switching between the windows is by means of *SCREEN A/B* hotkey. The current measurement is terminated when its window is blanked out.

Switching from split-screen to full-screen mode is performed in menu *DISP*.

Split Screen

In Split Screen mode, the screen is divided into two halves.

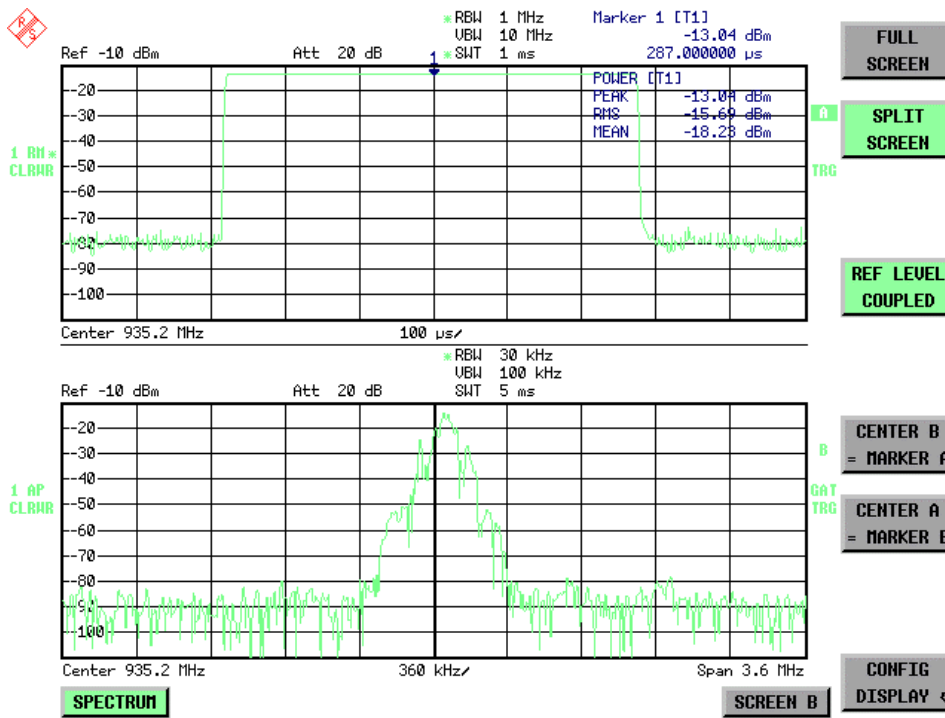

Fig.3-4 Subdivision of the screen in Split Screen mode

The upper half is assigned Screen A, the lower one Screen B. The settings for measurement can be selected independently for both screens. E.g., a spectrum may be displayed in Screen A and a time amplitude in the time range is displayed in Screen B.

The indications which are valid only for one window appear in the margin of the associated diagram. Indications which are valid for the two windows are displayed between the diagrams.

The window for entry of the measuring parameters or the marker operation is selected using the *SCREEN A/B* hotkey. The measurements are simultaneously performed in the two windows irrespective of the currently active one.

Switching from full-screen to split-screen mode is performed in menu *DISP*.

Softkey Area

The softkeys are assigned to the nine keys on the right side of the display. The setup of the softkey area is independent of the operating mode. It consists of the following graphic elements:

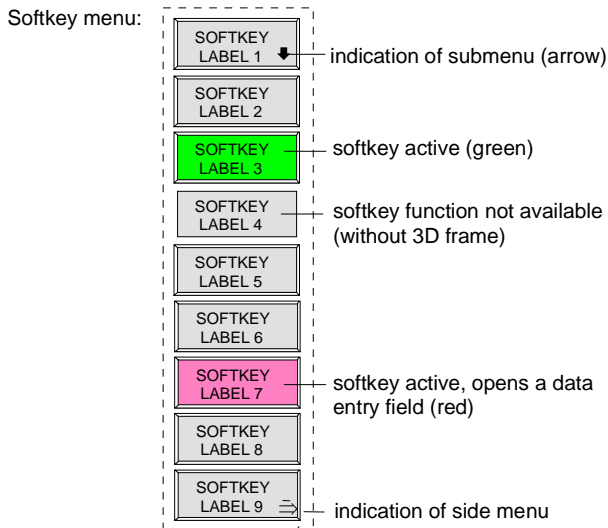

Fig.3-5 Setup of the softkey area

The softkeys have different functions depending on the instrument state. Therefore, their labeling can be varied. The labeling of all softkeys which call a submenu includes a ↓ arrow. The function and current state of the softkeys is indicated in the label by different texts and colors. The color assignment is factory-set as follows:

Table 3-1 Factory-set color assignment of soft keys

Softkey color	Meaning
gray	Softkey switched off
green	Softkey switched on
red	Softkey switched on and data entry active

These colors can be changed by the user as desired in the *DISP - CONFIG DISPLAY* menu.

A softkey is switched on or off by pressing the respective hardkey (see following section "Setting the Parameters").

Softkeys are masked out, too, if the functionality which they represent is not available. A distinction has to be made between two cases:

- If an instrument function depends on an option, and if this option is not fitted, the associated softkey is masked out,.
- If the instrument function is not available temporarily due to specific settings, the softkey is displayed without the 3D frame.

The label  on the right lower corner of the softkey area indicates that a side menu is available. The side menu is called by pressing the *NEXT* key.

Hotkey Area

Hotkeys are allocated to the eight keys on the bottom margin of the screen. They change between modes and the active diagrams.

The menu only shows the hotkeys which are actually used:

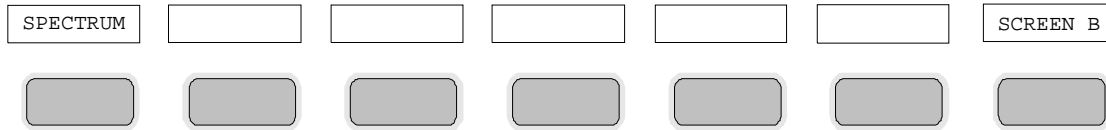

A keystroke activates the associated hotkey. An activated hotkey changes its frame:

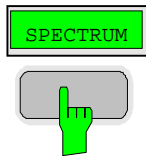

Calling and Changing the Menus

The operation of the spectrum analyzer is menu-controlled via keys and softkeys. Various softkey menus are displayed depending on the instrument status. The individual menus constitute the so-called menu tree. The top menu (the root of the menu tree) is always called by means of a keystroke. Arrows at the lower edge of the softkey area indicate whether a supplementary menu can be entered or not.

Softkeys with an arrow allow for branching into further menus (so-called submenus): The field "→" at the lower right side of the softkey area indicates that this menu has a side menu.

The menu change keys on the front panel below the softkey area allow for switching between the main menu and the side menus and submenus.

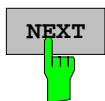

The *NEXT* key calls the side menu.



The *PREVIOUS* key returns to the next higher menu.

Several menus provide for automatic change, i.e., return to the next higher menu is caused automatically after pressing a softkey.

Selection of a submenu is always effected via a softkey.

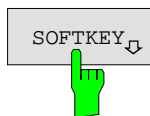

The labeling of all softkeys which call a submenu includes a ↓ arrow.

Setting Parameters

Parameters are set either by simple selection (selection parameters) or by (alpha)numeric entries in data entry windows or tables.

The numeric keypad on the front panel, an external keyboard (optional), a spinwheel and the cursor keys are provided for the entry of instrument parameters in an entry window or in a table.

The external keyboard is optional. If it is not fitted, the help line editor is called automatically for entry of alphanumeric parameters. The help line editor provides for selection of individual letters and a number of special characters which are copied into the actual entry window.

Numeric Keypad



The numeric keypad is provided for entry of numeric parameters. It contains the following keys:

- Number keys 0 to 9
- Decimal point
Inserts a decimal point "." at the cursor position.
- Sign key
Changes the sign of the mantissa or exponent of a numeric parameter.
A "-" is inserted at the cursor position in case of an alphanumeric parameter.
- Unit keys (*GHz/-dBm*, *MHz/dBm*, *kHz/dB* and *Hz/dB*)
 - Provide the numeric value entered with the selected unit and terminate the entry.
The unit keys are all assigned the value "1" for dimensionless quantities or for level entries (e.g., in dB). The unit keys thus assume the function of an *ENTER* key. The same applies for an alphanumeric entry.
 - Open and close the selection windows of tables.
- *BACK* key
 - Deletes the character left to the cursor with numeric entry.
 - Allows for toggling between the current and the previous values subsequent or prior to entry (*UNDO* function).
- *ESC/CANCEL* key
 - Aborts the entry before it has been terminated. The previous value is restored.
 - Closes the entry field after termination of input.
 - Closes system messages.
- *ENTER* key
 - Terminates the input of dimensionless quantities. The new value is set.

Note: The *ENTER* keys assumes the function of the *Hz* key for frequency input, and the function of the μ s(*kHz*) key for time input.

Spinwheel and Cursor Keys

The spinwheel and the cursor keys are arranged besides the numeric keypad.



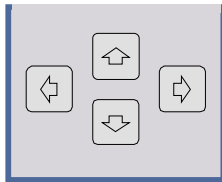

The spinwheel has various functions:

- With numeric entry, the instrument parameter is incremented (turning clockwise) or decremented (turning counterclockwise) at a defined step size.
- In tables, the spinwheel can be used to shift the cursor horizontally or vertically when no entry window is open. The direction (horizontal/ vertical) is switched over using the cursor keys.
- The spinwheel is used with the help-line editor to select the individual letters.
- It can be used to shift markers, display lines, limit lines etc.
- Pressing the spinwheel terminates the input of parameters.



In tables, the cursor keys are used to shift the cursor between the lines and columns of the table.

The keys  and  are used to shift the cursor inside the entry window to reach a particular position in the string.

The keys  and 

- increase or decrease the value of a parameter for numeric input .
- switch between editing line and help line editor for alphanumeric input.

Selection and Setting of Parameters via Keys or Softkeys

The selection of parameters and their settings is effected by means of a key, a softkey or in a table depending on the hierarchical level of the menu they are assigned to. Selection and setting of parameters in tables is described in section "Selection and Setting of Parameters in Tables".

Selection via key

Most keys of the network analyzer are used to enter menus where the selection and the settings are made. Few settings can be made directly by means of a keystroke, only.

Example: Call up of preset settings

- Press *PRESET* key

The spectrum analyzer is brought into a predefined initial state.



Selection via softkey

In most cases the selection is made by pressing the respective softkey. There are various alternatives of making the selection:

1. The softkey is active or inactive.

Example: Switching on/off the frequency counter

- Press *MKR* key.
- Press *SIGNAL COUNT* softkey.

Each time the softkey is pressed, the marker info list is switched on or off. If the softkey is active (= marker info list on), it is illuminated.

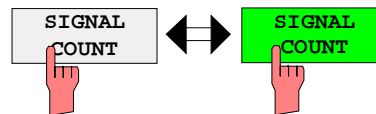

2. The softkey acts like a toggle switch, each pressing changes the active selection.

Example: Selection of the reference (internal or external)

- Press *SETUP* key.
- Press *GENERAL SETUP* softkey, the *GENERAL SETUP* submenu is opened.
- Press *REFERENCE INT/EXT* softkey.

With each pressing, the checkmark on the softkey changes from INT (internal reference) to EXT (external reference) and vice versa. When in the active setting the softkey menu item is illuminated.

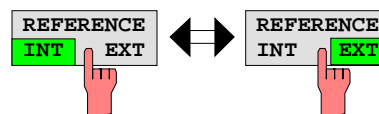

- 3. Various softkeys act like selection switches. Only one softkey may be active at a time.

Example: sweep setting

- Press *SWEEP* key.
- Press *CONTINUOUS SWEEP* softkey.

The continuous sweep is thus set. The *CONTINUOUS SWEEP* softkey is colored (factory-set: green). The second alternative, a series of n sweeps according to the trigger definition, can be selected via the *SINGLE SWEEP* softkey in the same menu. Only one of the two softkeys can be active at a time, the softkeys thus act like selection switches.

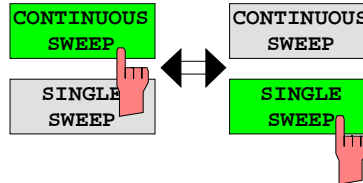

- 4. The softkey is used to select the parameter, the setting is made in an alphanumeric data entry window.

Example: SWEEP COUNT parameter

- Press *SWEEP* key
- Press *SWEEP COUNT* softkey.

The window for entering the number of sweeps for the *SINGLE SWEEP* mode is opened. The softkey is colored (factory-set: red). (Data entry is described in the next section).

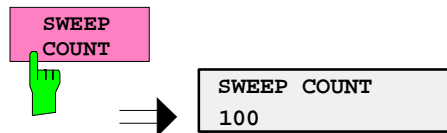

4. The softkey is used to select the parameter, the setting is made in an (alpha)numeric data entry window. The softkey function is switched on. To switch off the function, the softkey has to be pressed again.

Example: parameter MARKER

- Press *MRK* key.
- Press *MARKER 1* softkey.

The window for entering the marker frequency is opened. The softkey is colored (factory set: red). Marker 1 is switched on and the peak search is started.

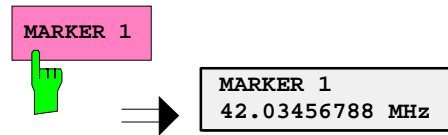

- Press *MARKER 2* softkey.

The entry window for the marker frequency of marker 2 is opened. The softkey is colored (red), marker 2 is switched on, and the *MARKER 1* softkey turns green.

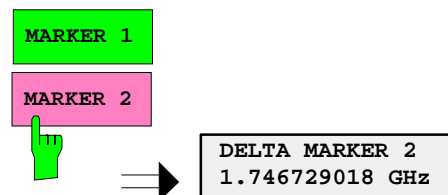

- Press *MARKER 1* softkey again.

Marker 1 is switched off.

5. The softkey selects the parameter, the setting is made in a selection table.

Example: Selection of the sorting criteria of a file list

- Press *FILE* key.
- Press *FILE MANAGER* softkey.
- Press *SORT MODE* softkey.

A selection table is displayed. The softkey is colored (factory-set: red). (operation see below).

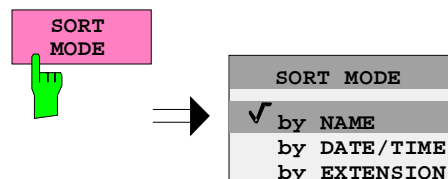

Editing of Numeric Parameters

The entry of numeric values is always made in a data entry window, which is displayed automatically after selection of the parameter.

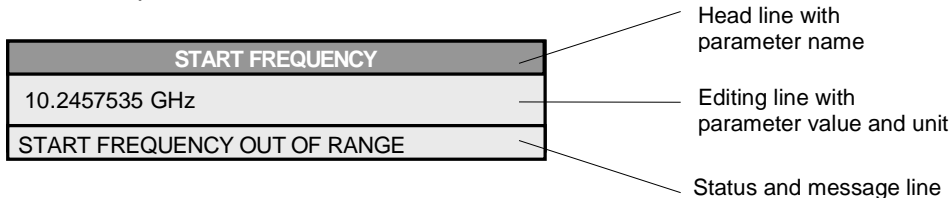

The headline indicates the name of the instrument parameter, which has been selected. The entry is made in the editing line. Subsequent to calling the entry window, the current parameter value including the unit is displayed left-justified in the editing line. Status and error messages which refer to the current entry are displayed in the third and (optionally) fourth line.

Note: Entry windows may be represented transparent (cf. DISPLAY - CONFIG DISPLAY menu)

Entry of a numeric value

- Call data entry window (cf. selection of parameters)
The editing line indicates the current value

Example: center frequency (frequency-sweep mode)

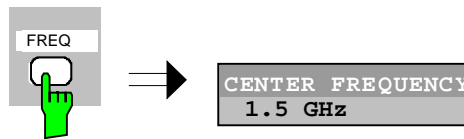

Entry via number keys

- Enter required value via number keys.

Example:

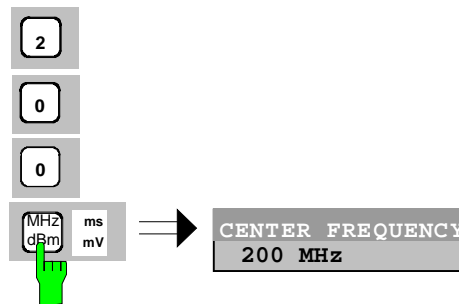

Entry via cursor keys

- Cursor or until obtaining the required value.

Example:

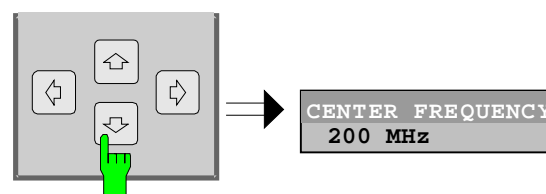

- Entry via spinwheel
- Rotate the spinwheel until reaching the required value.
The variation step size increases with increasing rotational speed.
 - Turning the spinwheel clockwise increases the value, turning it counterclockwise decreases the value.

Example:

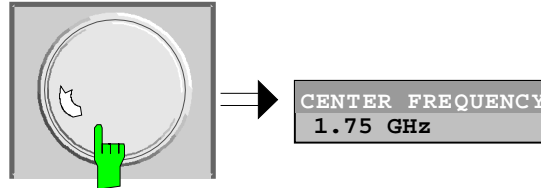

Note: When the value is modified by means of the spinwheel or the cursor keys the new value is immediately set.

Terminating the entry

- Press one of the unit keys
The unit is entered in the entry window and the new setting is accepted by the instrument.

For dimensionless quantities:

- Press the ENTER key or the spinwheel
The new setting is accepted by the instrument.

A few data entry windows close automatically whereas others like the entry window for the start frequency remain open even after termination of the entry. They can be closed by pressing the *ESC* key.

If an error occurs, a corresponding error message is displayed in the status line of the entry window, e.g., "Out of range", "Value adjusted", etc. In this case, the new value is not accepted for the instrument setting.

Example:

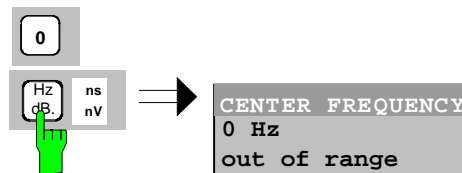

Correcting the entry

Deleting an entry

- Position the cursor beside the digit which is to be deleted using the cursor keys \leftarrow or \rightarrow .
- Press the *BACK* key. The entry left to the cursor is deleted.
- Enter new numbers. The number is inserted to the left of the cursor, the other numbers are shifted right.

Restoring the original value

- Press the *BACK* key

For numerous parameters, the data administration of the instrument stores the previously valid parameter value in addition to the current value. The *BACK* key can be used to toggle between these two values. This applies for terminated entries as long as the data entry window is displayed.

Aborting the entry

- Press *ESC* key

The original parameter value is restored. The new entry is deleted.

- Press *ESC* key again

The entry window is closed, the original value remains active.

or

- Press any key or any softkey (even the softkey which has opened the entry window).

The entry is aborted and the entry window is closed. The original value remains active.

Entry of Alphanumeric Parameter

A help-line editor or an external keyboard (optional) are provided for the entry of alphanumeric instrument parameters.

The spinwheel and the exponent key have no function with alphanumeric entry. All unit keys assume the function of an ENTER key.

The entry is always made in a data entry window which is displayed automatically upon selection of the parameter. The editing line comprises 60 characters. Up to 256 characters may be entered. If a text exceeds 60 characters the contents is shifted automatically 20 characters left or right when the left or right margin of the editing line is touched by the cursor.

Editing with External Keyboard

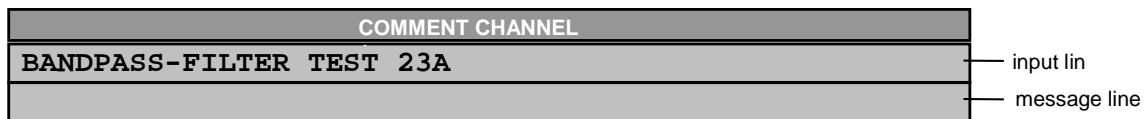

Entry of text

- Select parameter.
The data entry is active automatically upon calling the data entry window. The cursor is positioned at the beginning of the previous entry.
- Press the required character on the keyboard.
The character is inserted prior to the cursor.
- Enter further characters

Correcting the entry

- Delete the entry using the *DELETE* key or *BACKSPACE* key.

Terminating the entry

- Press the *ENTER* key of the external keyboard
The data entry window is closed and the new value is accepted for the instrument.

Aborting the entry

- Press the **ESC** key on the front panel
- or
- any softkey.
- The data entry window is closed, the original value is retained.

Editing with Help Line Editor

If the external keyboard is not fitted, the help line editor is called automatically with entry of alphanumeric parameters. The help line editor is an extension of the alphanumeric entry window. It contains the complete alphabet with uppercase and lowercase letters as well as special characters in two lines of 52 characters, each. Individual letters and a series of special characters can be selected in the help line editor and copied into the entry line.

The help line editor comes in two versions:

Version 1:

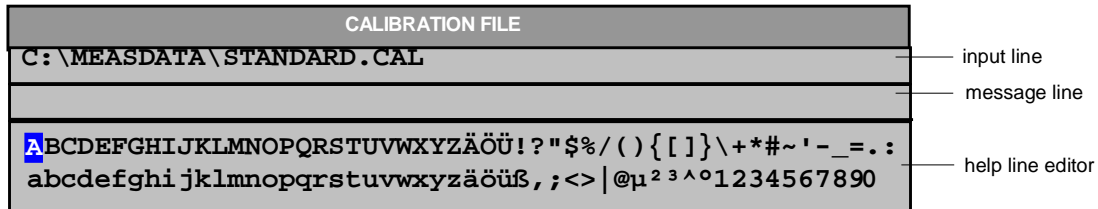

The cursor keys or toggle between entry in the editing line and selection in the help line editor.

Entry of text

- Select parameter.
The data entry is active automatically upon calling the data entry window. The cursor is positioned on the left in the editing line.
- Position the cursor in the help line editor using the cursor key.
The cursor marks the first letter of the editor.
- Locate the cursor on the character which is to be entered into the editing line using the cursor keys or or the spinwheel.
- Press the *ENTER* key or the spinwheel.
The character is entered in the editing line.

Correcting the entry

- Locate the cursor in the editing line using the cursor key .
- Position the cursor after the character which is to be deleted using the cursor keys and .
- Press the *BACK* key.
The entry left to the cursor is deleted.

Terminating the entry

- Locate the cursor in the editing line using the cursor key .
- Press any unit key or the spinwheel.
The data entry window is closed, the new entry is accepted by the instrument.

Aborting the entry



- Press the *CLR* key.
The data entry window is closed, the previous entry is retained.

Version 2:





													1	2	3	4	5	6	7	8	9	0
A	B	C	D	E	F	G	H	I	J	K	L	M	:	\	.	/	^	+	-	=	,	
H	O	P	Q	R	S	T	U	V	W	X	Y	Z	<	>	()	{	}	[]	#	~
a	b	c	d	e	f	g	h	i	j	k	l	m	'	@	;		?	!	"	€	\$	%
n	o	p	q	r	s	t	u	v	w	x	y	z	«	»	BACK	EXIT						
SPACE																						

The entry area consists of two parts:

- the editing line
- the character selection field





The cursor keys  or  are used to toggle between entry in the editing line and the character selection field .

Entry of text

- Select parameter.
The data entry is active automatically upon calling the data entry window. In tables, the help line editor is accessed by the cursor key  .
In the editing line, the cursor is positioned at the beginning of the current entry.
- Position the cursor to the character selection field using the cursor key  .
The cursor highlights the first letter of the editor.
- Position the cursor to the character to be entered in the editing line by means of the cursor keys  or  or the spinwheel.
- Press the *ENTER* key or the spinwheel.
The character will be entered in the editing line.

**Correcting the entry
(Version 1)**

- Move to the character << in the character selection field using the spinwheel.
- Position the cursor behind the character to be deleted by moving and pressing the spinwheel on << and >>.
- Move to the *BACK* field using the spinwheel and press the spinwheel.
The entry to the left of the cursor in the editing line will be deleted.

- Correcting (Version 2)** **the entry** ➤ Position the cursor to the editing line by means of the cursor key  .
- Position the cursor after the character to be deleted by means of the cursor keys  and  or with the spinwheel.
 - Press the *BACK* key.
The entry to the left of the cursor will be deleted.
- Terminating (Version 1)** **the entry**
- Select the EXIT field using the spinwheel and press the spinwheel.
The data entry window will be closed; the new entry will be accepted by the instrument.
- Terminating (Version2)** **the entry** ➤ Move the cursor to the editing line using the cursor key  .
- Press one of the unit keys or the spinwheel.
The data entry window will be closed; the new entry will be accepted by the instrument.
- Interrupting the entry**
- Press the *ESC* key.
The data entry window will be closed; the previous entry will be retained.

Selection and Setting of Parameters via Tables

The spectrum analyzer uses numerous tables for display and configuration of instrument parameters.

The tables differ considerably in the number of lines, columns and inscriptions. The basic steps of operation for the selection and setting of parameters are, however, the same for all tables. Shown below is the typical entry of parameters into a table.

Note:

Most of the tables are coupled to a softkey menu which provides further functions for editing table entries such as deletion of tables, copying of lines or columns, marking of table elements, restoring default states.

The definition of individual tables and the operation of particular editing functions can be looked up in the description of the corresponding softkey menu.

1. Activating the table

- If the menu has only one table, the latter is activated automatically subsequent to calling this menu in most cases and the marking cursor is positioned to the top field of the left column.
- If the menu contains various tables, the table of interest must be selected using the softkey which is labeled with the title of the table.

2. Selection of the parameter

LIMIT LINES				
NAME	COMPATIBLE	LIMIT CHECK	TRACE	MARGIN
GSM22UP	✓	off	1	0 dB
✓ LP1GHz		on	2	0 dB
✓ LP1GHz	✓	off	1	0 dB
MIL461A		off	2	-10 dB

marking cursor

Selection of the parameter (or the setting) is made using the marking cursor.

- Press the cursor keys to move to the wanted field.

or

- Rotate the spinwheel until the wanted field is marked. The cursor keys are used to specify the direction of the spinwheel movement (horizontal or vertical)

When shifting the cursor, elements may be skipped which can not be edited. Table elements, which can not be selected are indicated by a different color.

- Press the *ENTER* key or the spinwheel.
The parameter/the setting has been selected.

The selected parameter can be edited the way described below:

3. Editing the marked parameter

LIMIT LINES				
NAME	COMPATIBLE	LIMIT CHECK	TRACE	MARGIN
GSM22UP	✓	off	1	0 dB
✓ LP1GHz		on	2	0 dB
✓ LP1GHz	✓	off	1	0 dB
▲ MIL461A		off	2	-10 dB

checkmark

TRACE
1
✓ 2
3

MARGIN
-10 dB

a) Toggling between two states

If an element of a table can be switched on and off only, the unit keys are used to toggle between these two states.

- Press one of the unit keys.
The table element is switched on and provided with a checkmark. (✓).
- Press one of the unit keys once more.
The table element is switched off.

or

- Press one of the unit keys.
The table element is switched on, "on" is displayed.
- Press one of the unit keys once more.
The table element is switched off, "off" is displayed

b) Opening a data entry window

If a table entry consists of an (alpha-) numeric value, the corresponding entry window will be opened after selecting the numeric value by pressing the *ENTER* key or the spinwheel.

Note 1: For numeric instrument parameters, the editing operation may be started by entering any number or letter on the front panel or on the external keyboard. In this case, the data entry window is opened automatically.

Note 2: For alphanumeric table fields for which the help line editor version 2 is required, the help line editor will be opened by pressing the *CURSOR DOWN* key after *ENTER*.

c) Opening a selection table

If a table entry may have various states (e.g., colors from a color pallet, fixed filter bandwidths, etc.), a table indicating all possible states is displayed with selection. The current state is and marked by a checkmark and by the cursor.

- Set the cursor to the desired setting.
- Press one of the unit keys.
The setting is switched on and marked (√). The selection table closes and the value is transferred to the original table. The cursor is positioned automatically on the next table element.

Abortion of entry

- Press the *ESC* key.

The current entry/selection is aborted and the original setting is restored.

Scrolling

Some tables contain more entries than can be displayed on one screen page. In this case, a **scrollbar** is displayed at the right margin of the table, whose slider shows the current position in the text.

- Actuate the *PAGE UP* or *PAGE DOWN* softkeys.

The table is paged forward or back by one page.

- Press cursor key  or .

The table is scrolled up or down by one line.

Menu Overview

The following section gives a graphical overview of the FSP menus. Side menus are marked by an arrow directed to the left/right, submenus by an arrow showing upwards.

The menus appear in the order corresponding to the arrangement of keys on the front panel. The available hotkeys and the LOCAL menu appearing during the remote control of the instrument are also displayed.

The functions of menus are described in detail in Chapter 4. The IEC/IEEE-bus command associated with each softkey is indicated. In addition, the softkey list at the of Chapter 6 gives the assignment of IEC/IEEE-bus commands to softkeys.

FREQUENCY Key

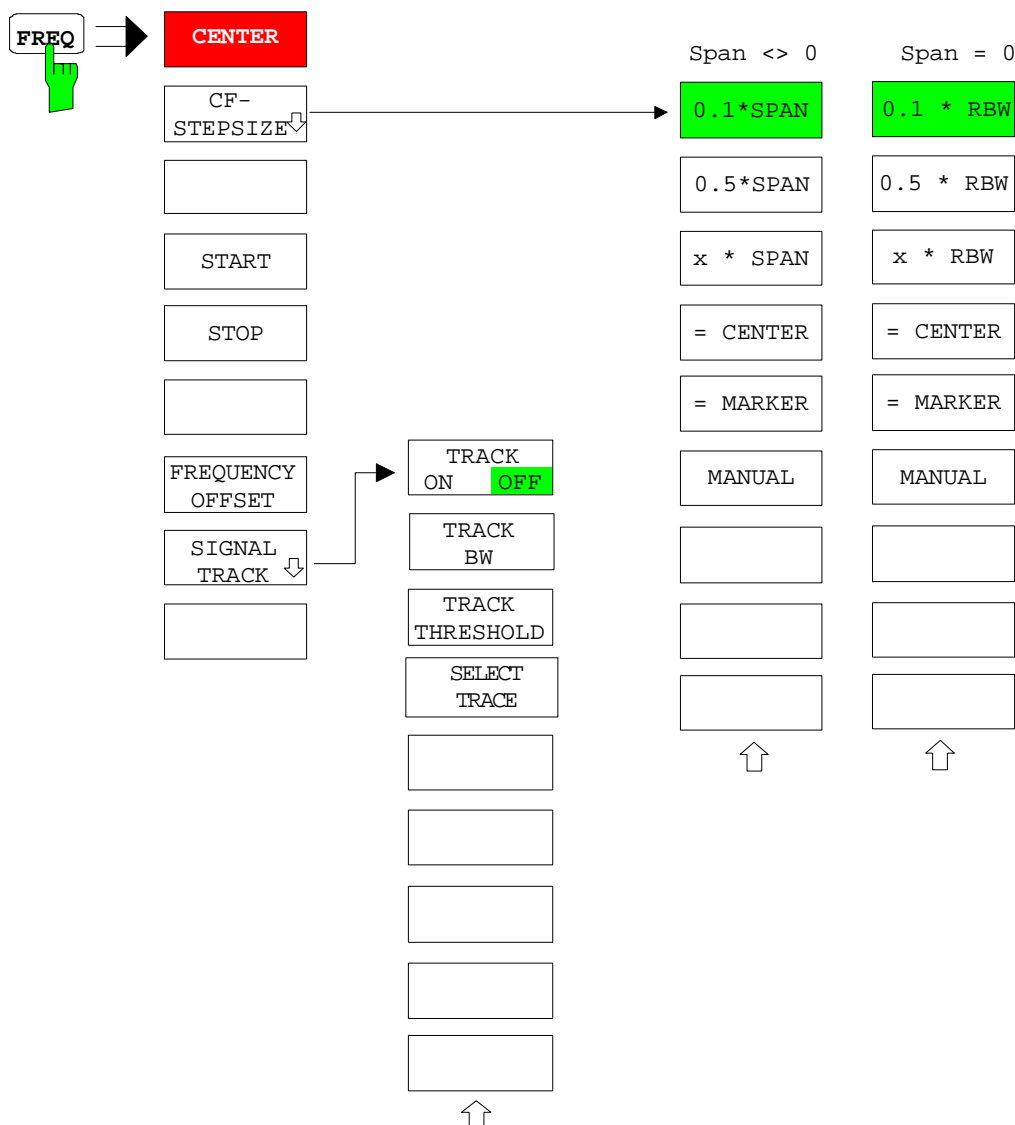

SPAN Key

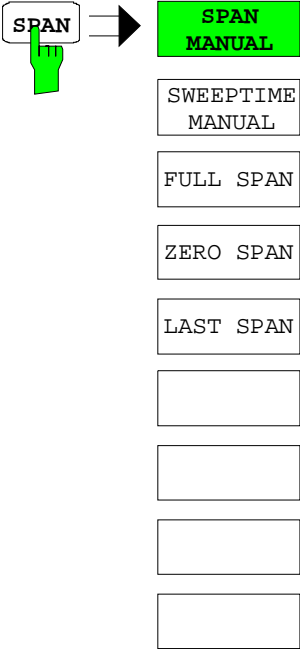

AMPT Key

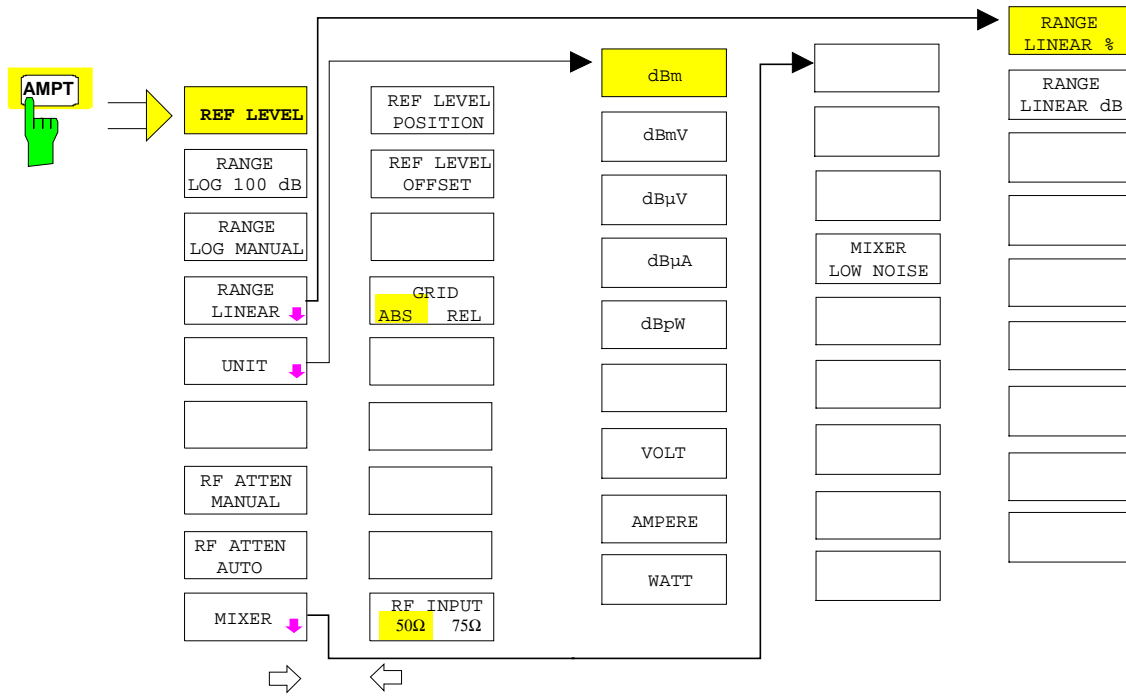

MKR Key

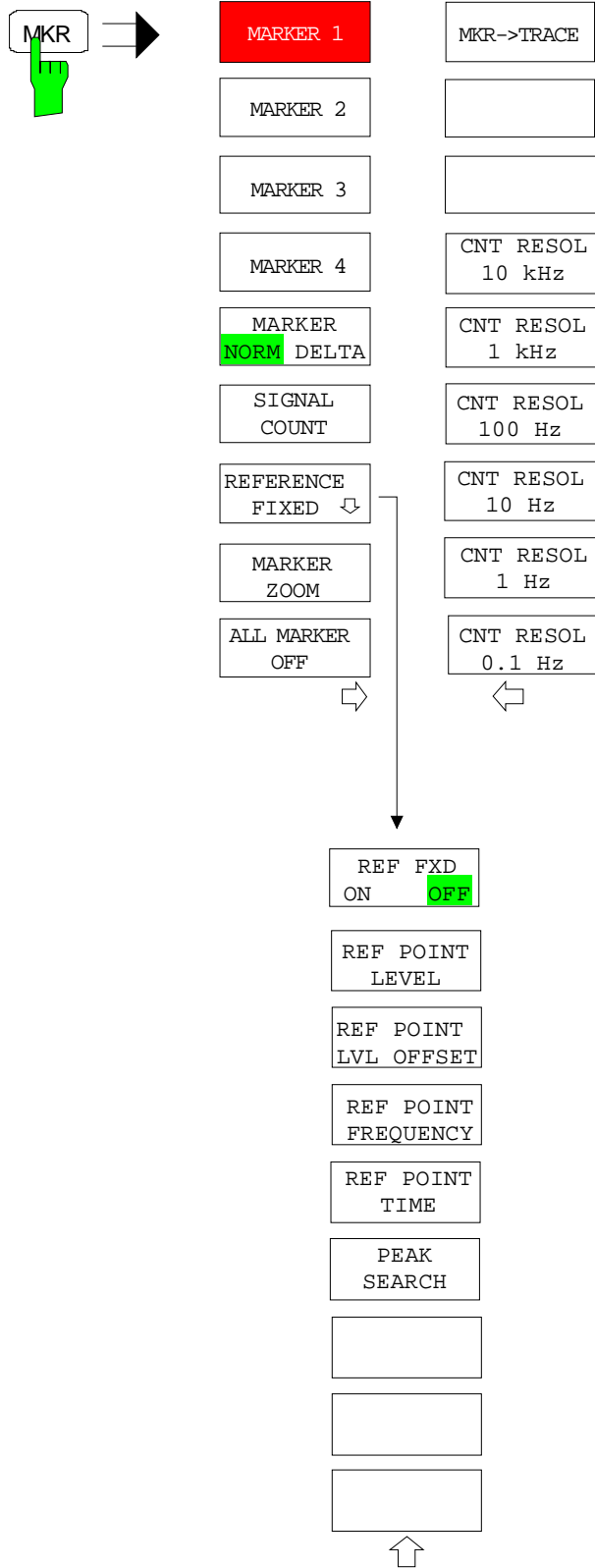

MKR-> Key

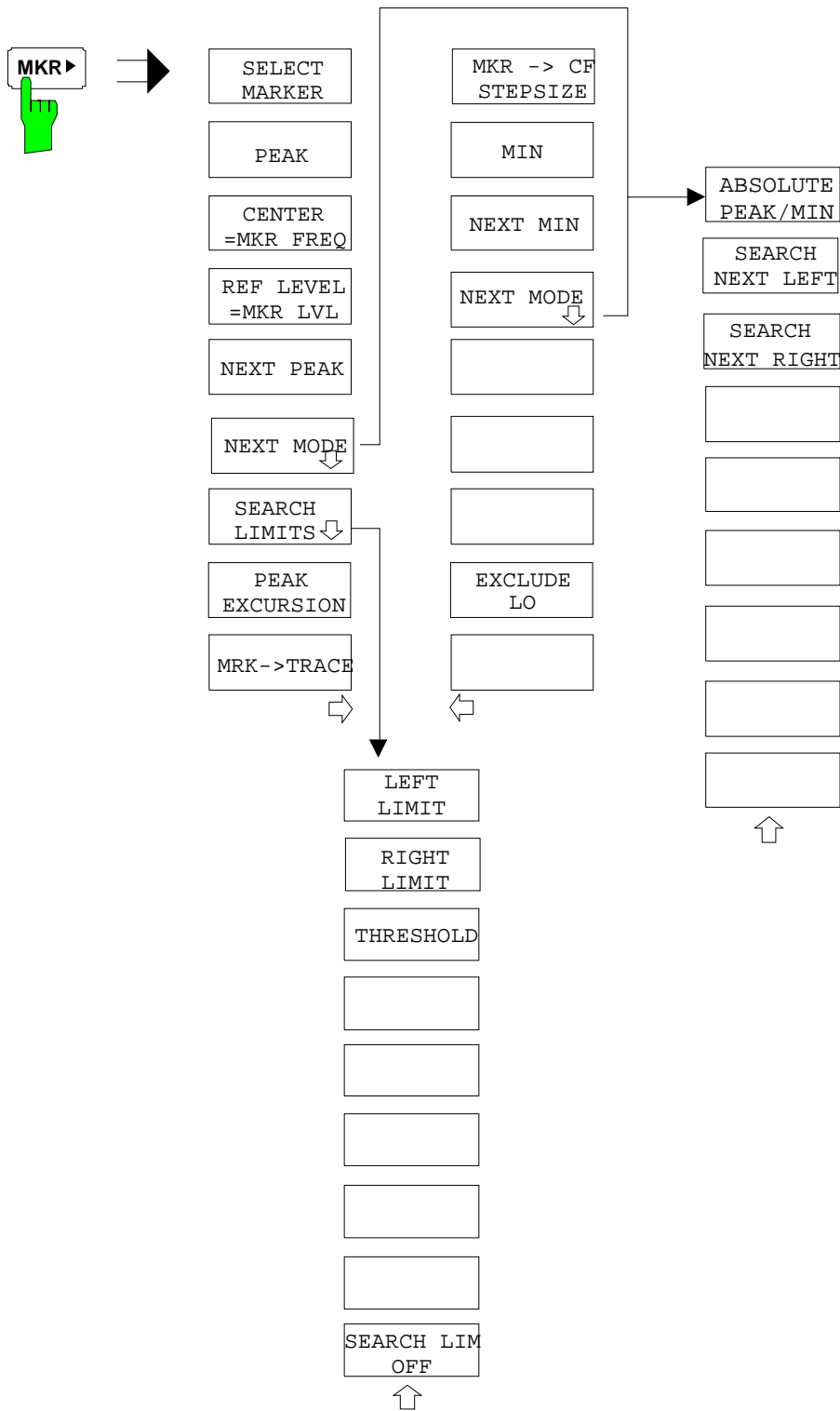

MKR FCTN Key

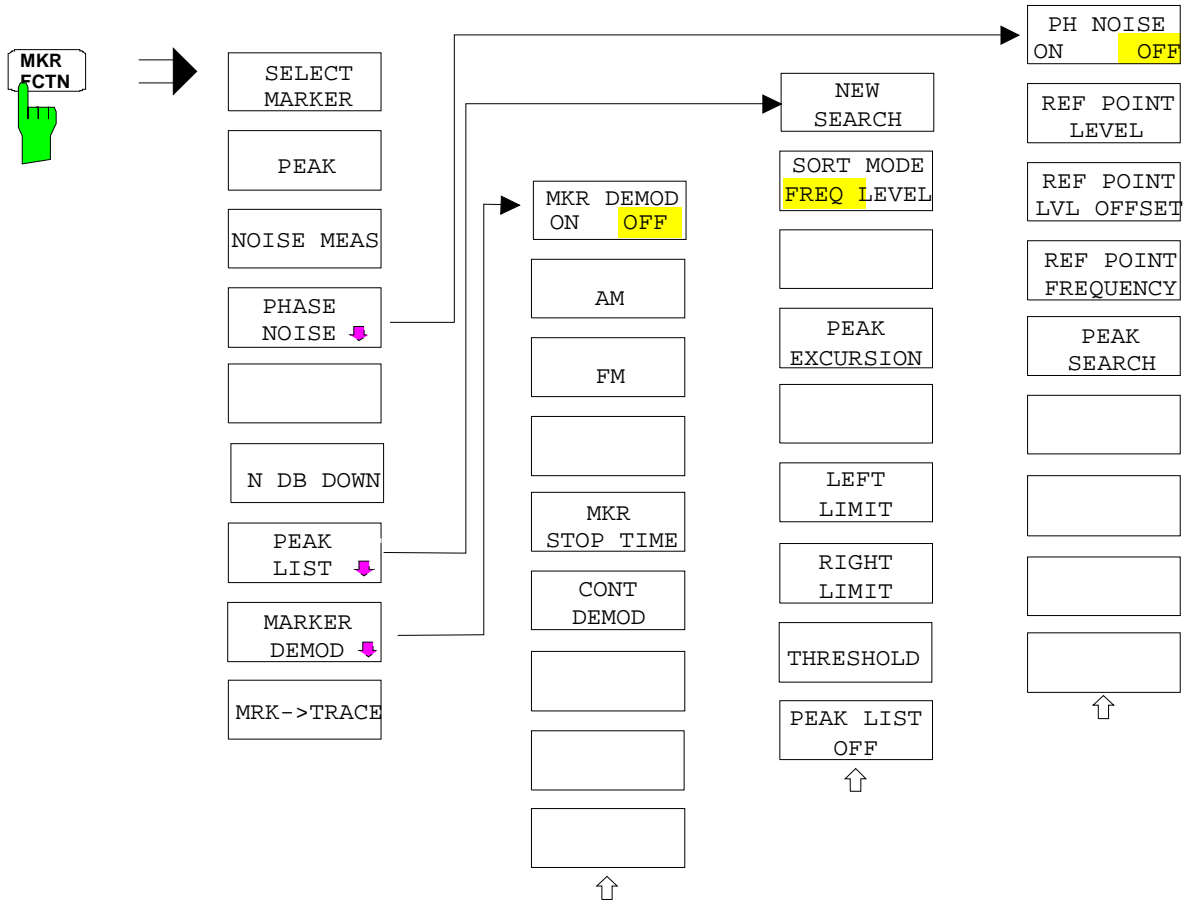

MEAS Key

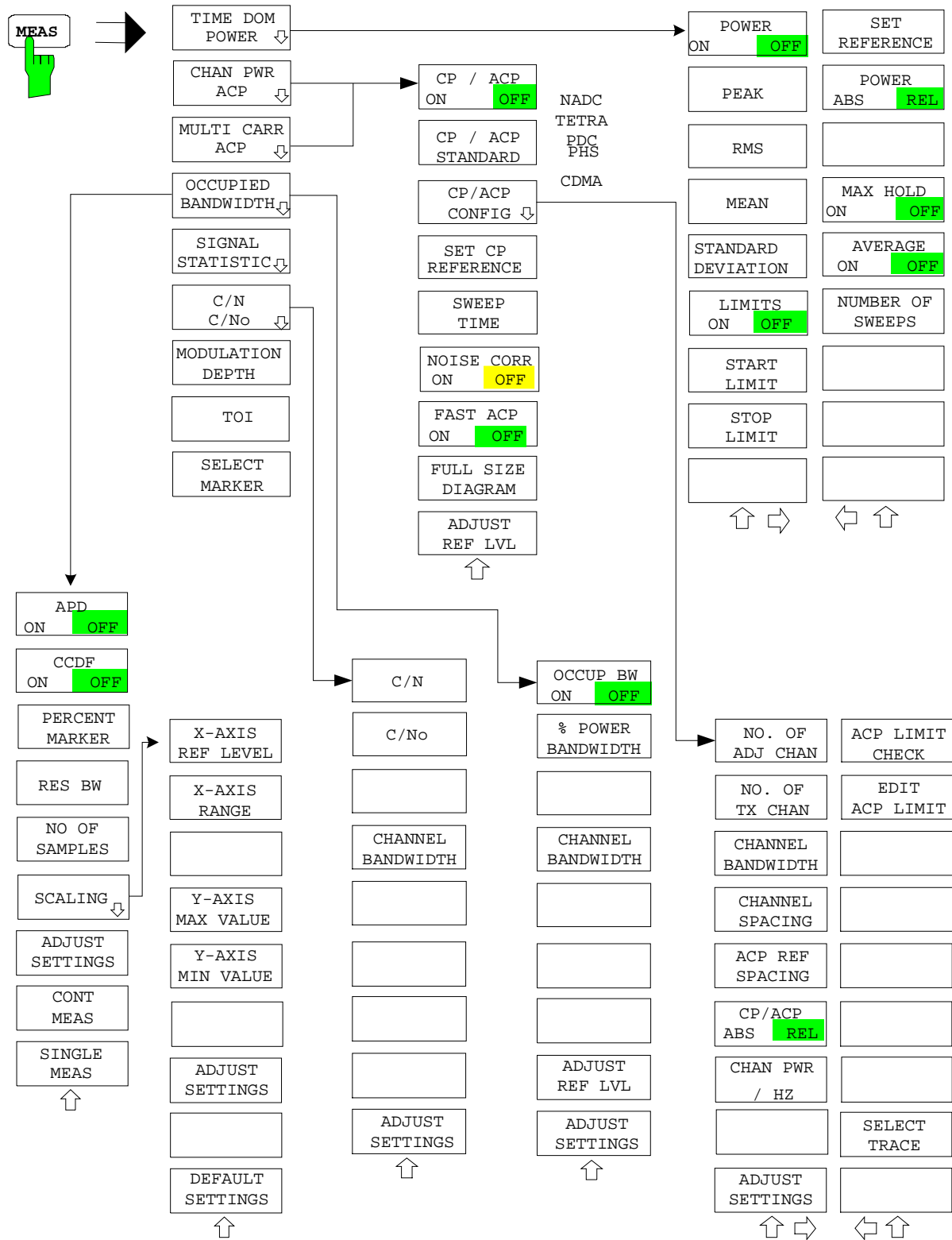

BW Key

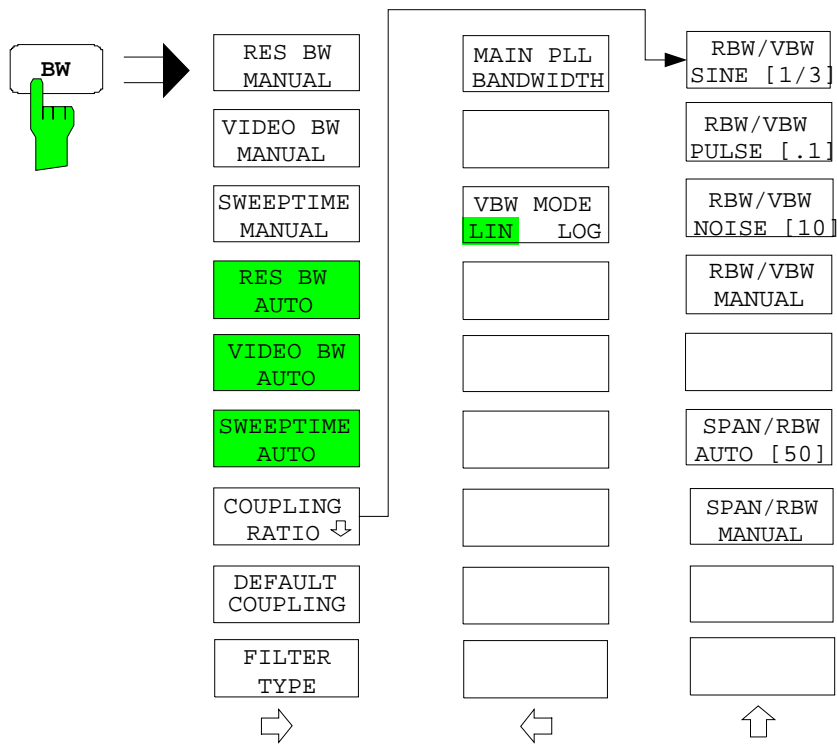

SWEEP Key

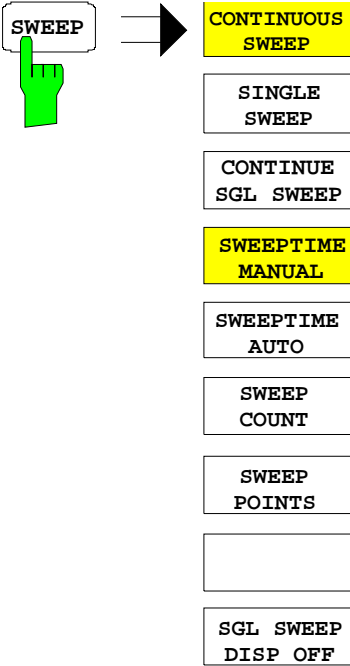

TRIG Key

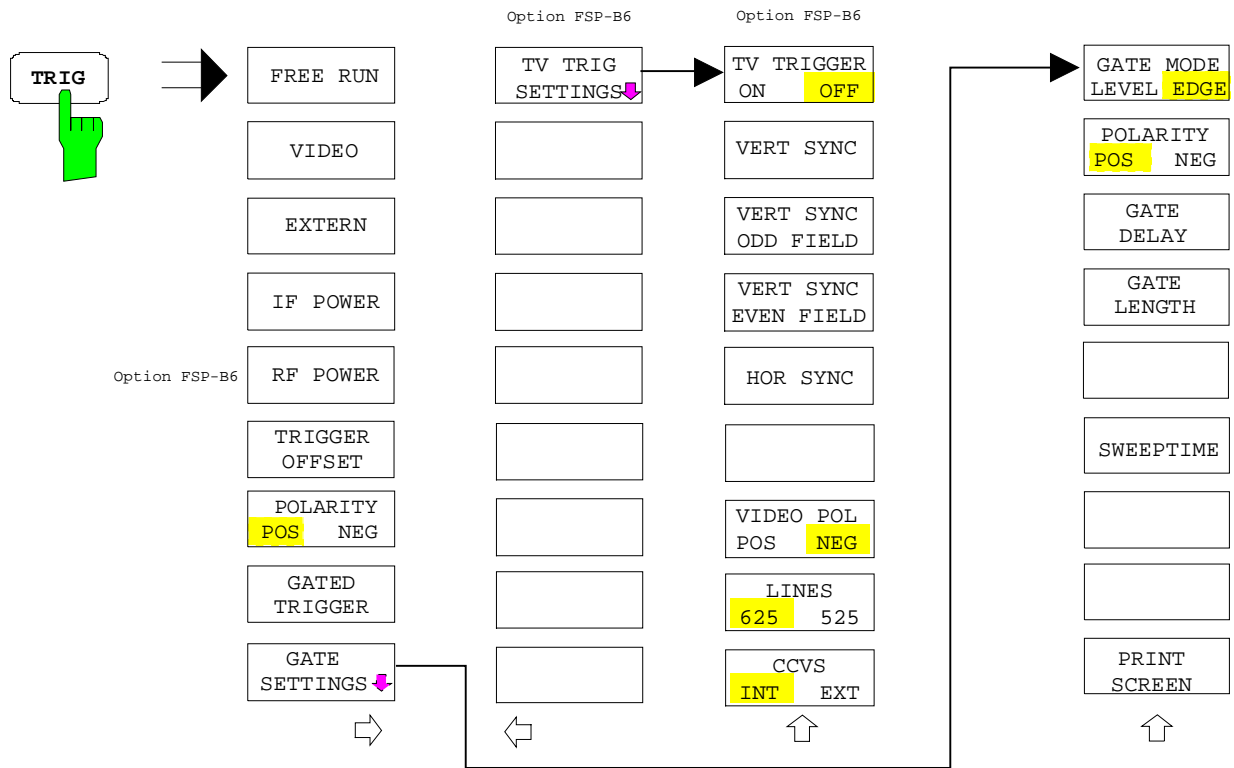

TRACE Key

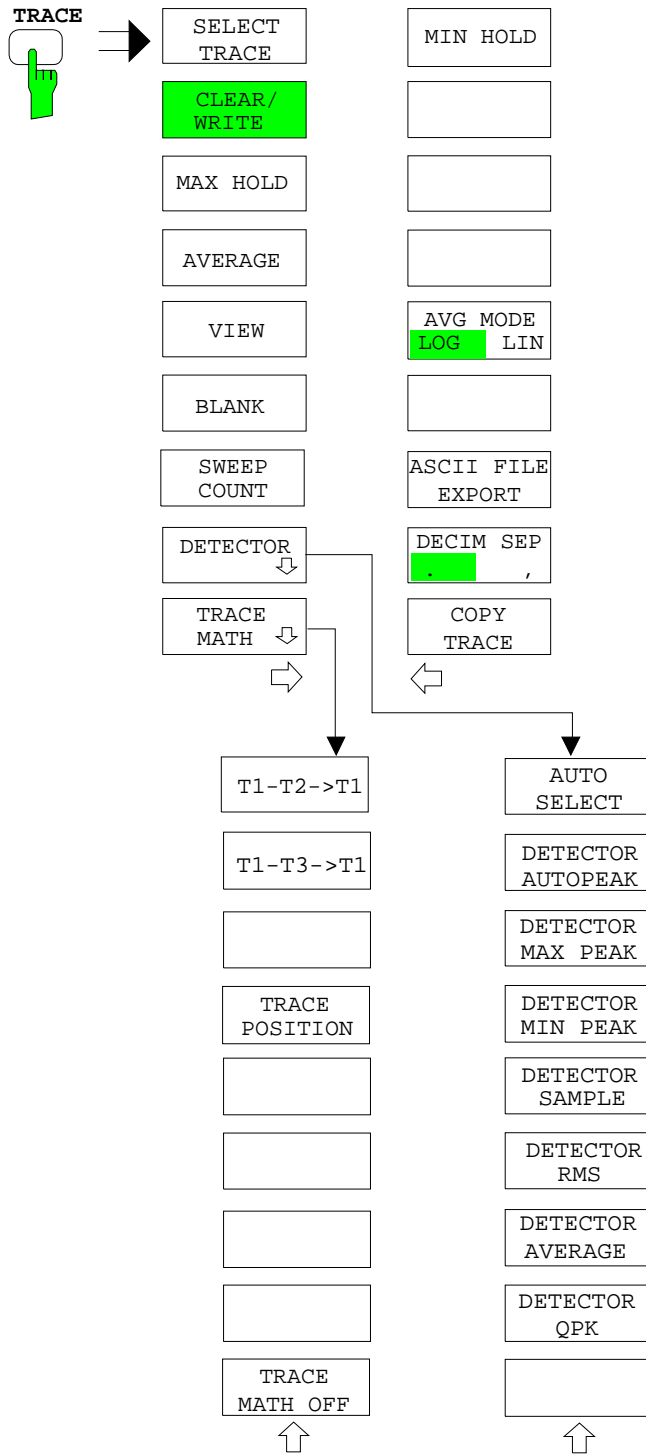

LINES Key

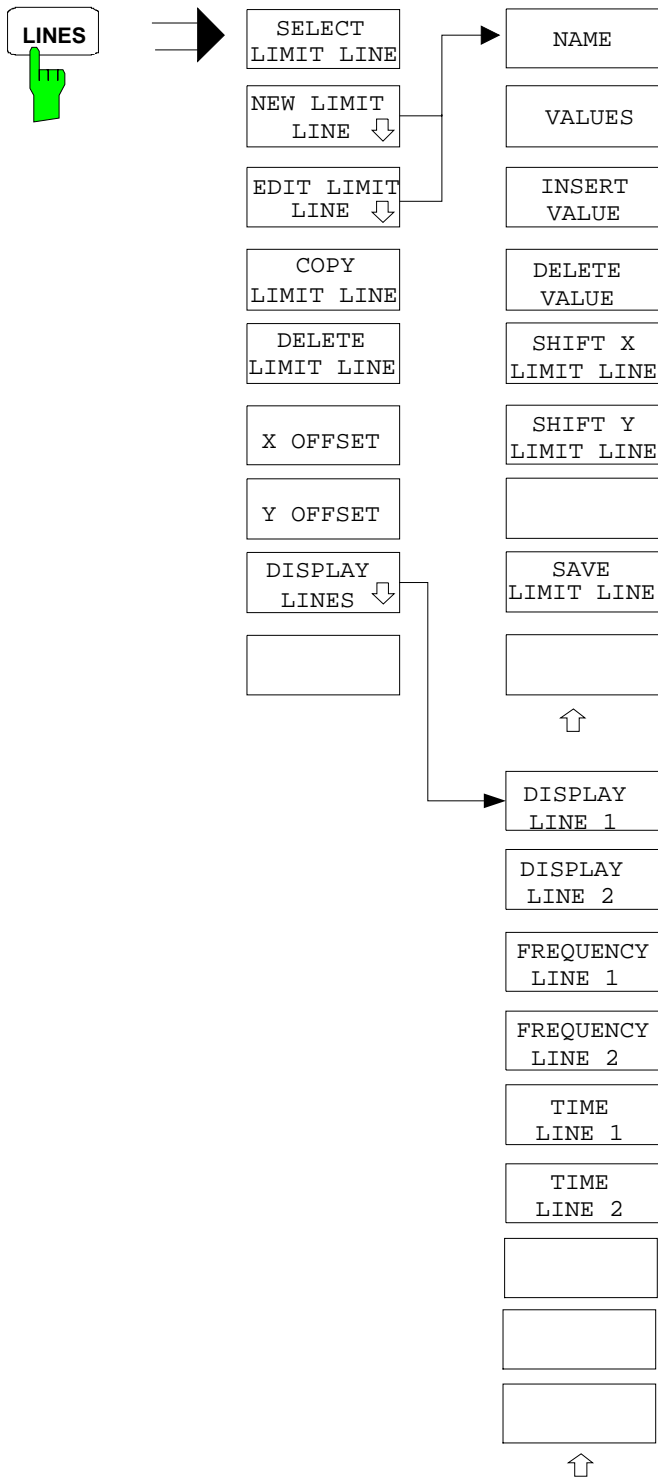

DISP Key

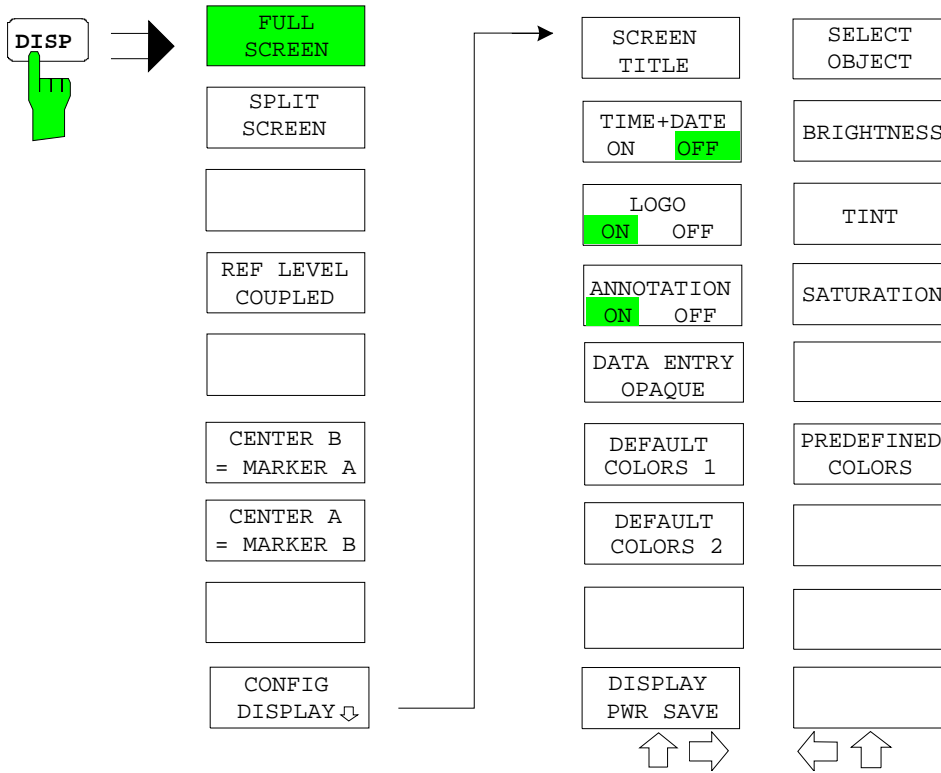

FILE Key

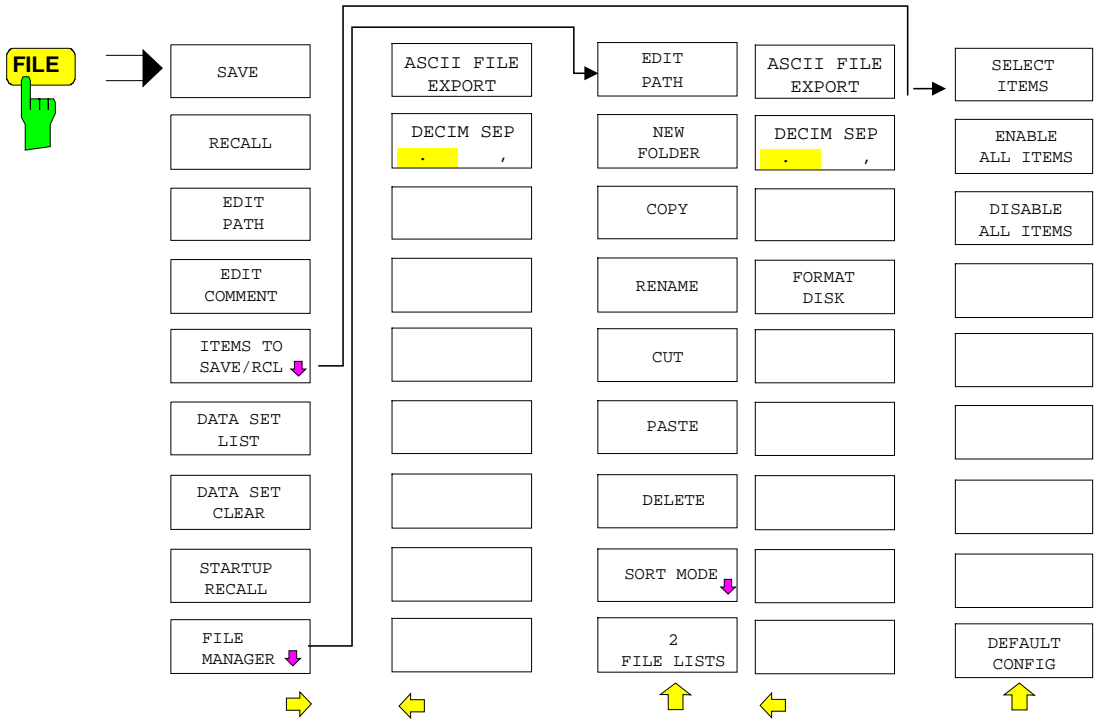

CAL Key

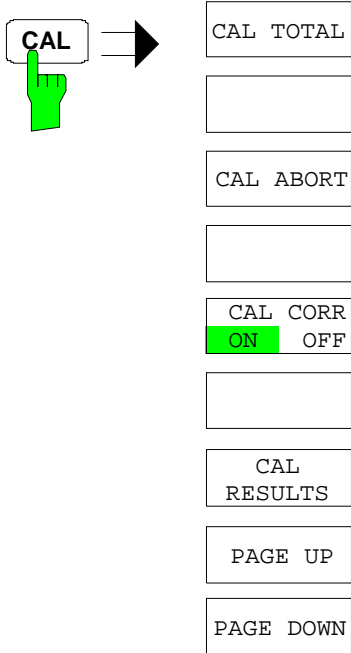

SETUP Key

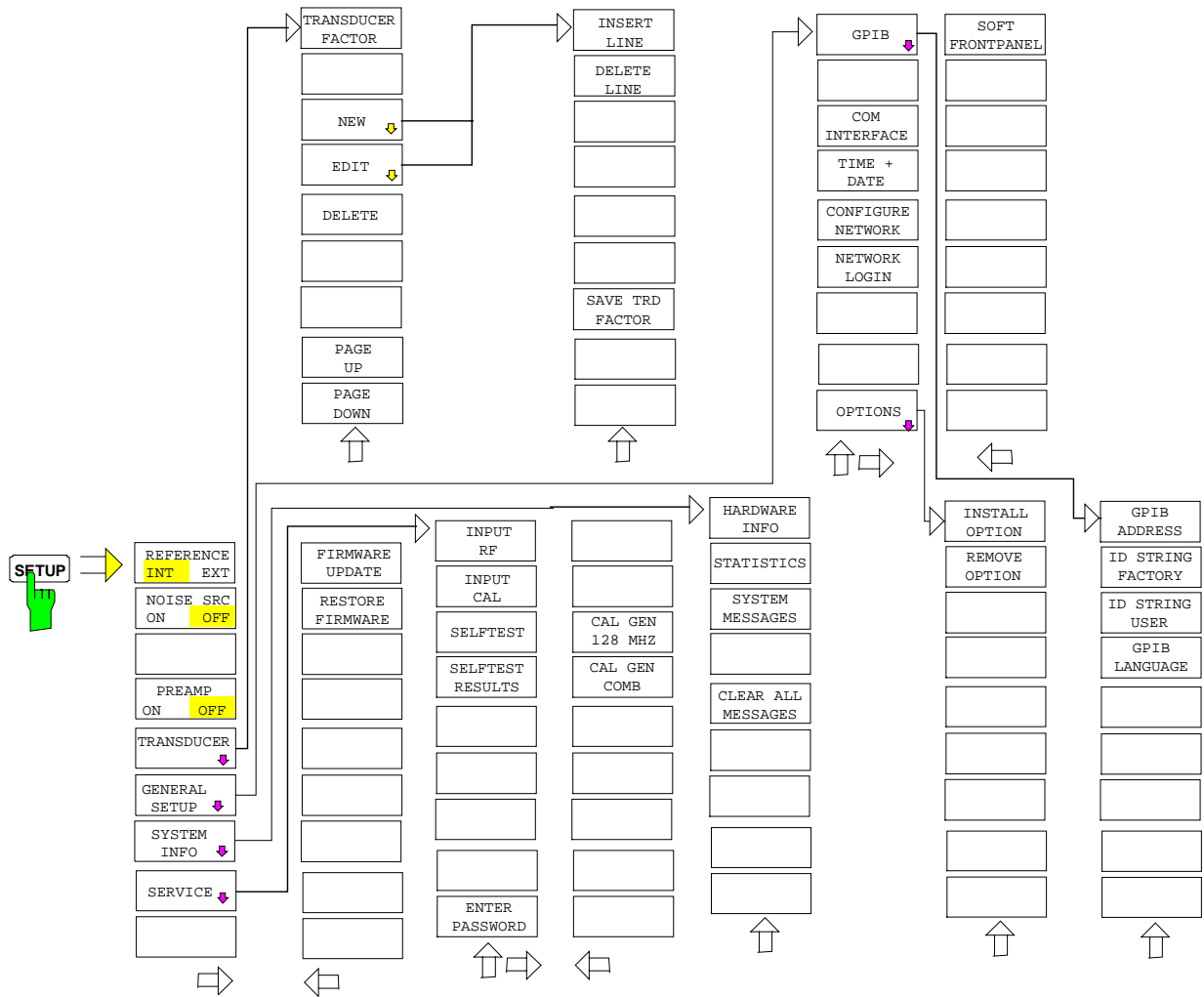

HCOPY Key

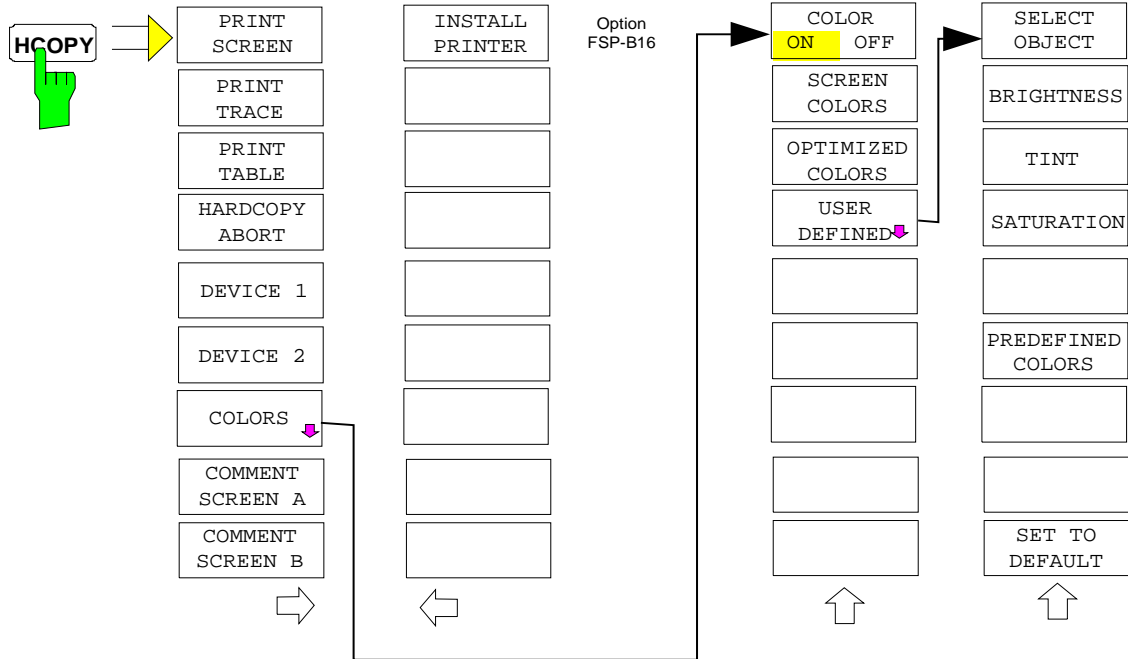

Hotkey Menu

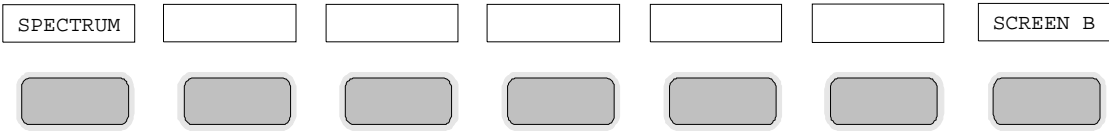

LOCAL Menu



Menu Overview Network Mode

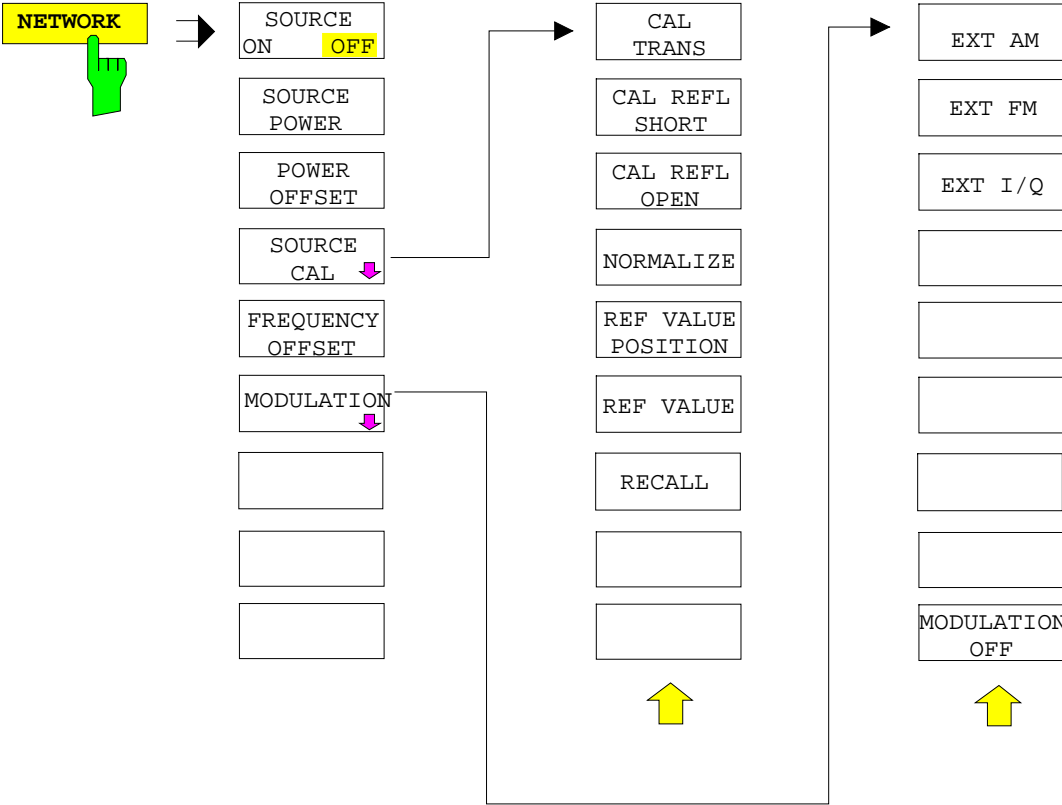

Menu Overview Option Ext. Generator Control

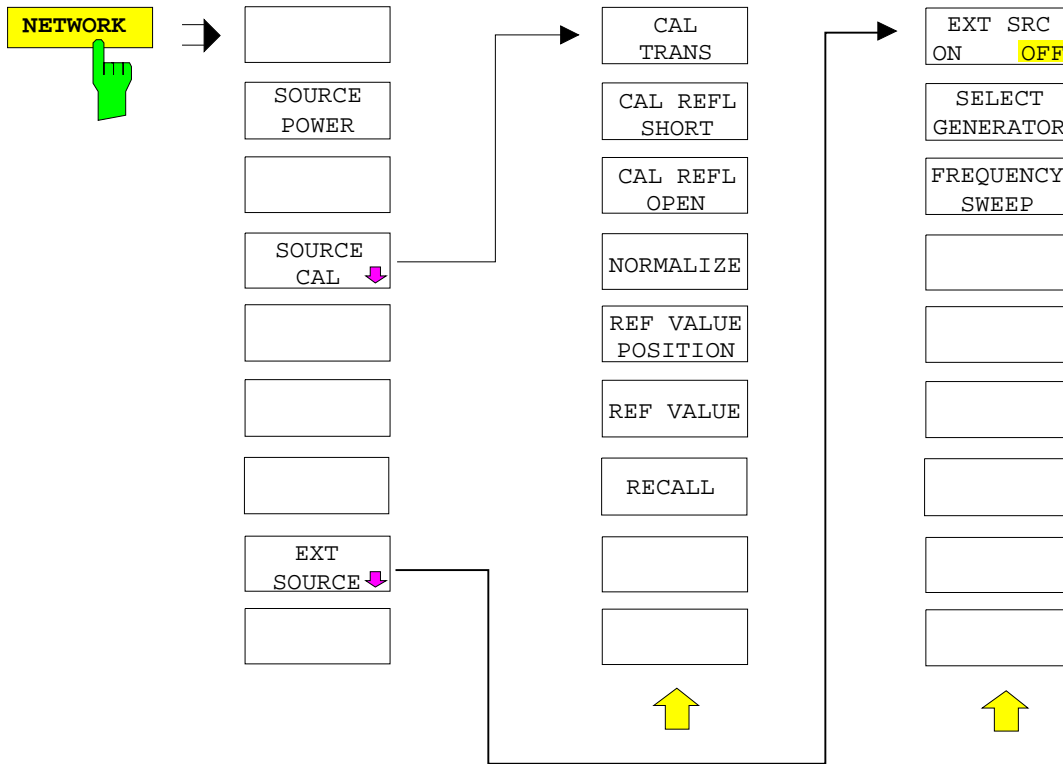

Contents - Chapter 4 "Instrument Functions"

4 Instrument Functions	4.1
FSP Initial Configuration – PRESET Key	4.2
Mode Selection – HOTKEY Bar	4.2-1
Return to manual control – LOCAL Menu	4.3-1
Spectrum Analyzer Mode	4.4.1
Frequency and Span Selection – <i>FREQ</i> Key.....	4.4.1
Setting the Frequency Span – SPAN Key	4.5-1
Level Display Setting and RF Input Configuration – AMPT Key	4.6-1
Electronic Attenuator	4.6-5
Setting the Bandwidths and Sweep Time – BW Key	4.7-1
List of available channel filters	4.7-9
Sweep Settings – SWEEP Key	4.8-1
Triggering the Sweep – TRIG Key	4.9-1
Option FSP-B6 – TV and RF Trigger	4.9-8
Selection and Setting of Traces – TRACE Key	4.10-1
Selection of Trace Function.....	4.10-1
Selection of Detector	4.10-9
Mathematical Functions for Traces	4.10-14
Recording the Correction Data of FSP – CAL Key	4.11-1
Markers and Delta Markers – MKR Key	4.12-1
Frequency Measurement with the Frequency Counter.....	4.12-3
Marker Functions – MKR FCTN Key	4.13-1
Activating the Markers	4.13-2
Measurement of Noise Density	4.13-2
Phase Noise Measurement	4.13-4
Measurement of the Filter or Signal Bandwidth.....	4.13-6
Measurement of a Peak List.....	4.13-7
AF Demodulation.....	4.13-9
Selecting the Trace.....	4.13-10
Change of Settings via Markers – MKR ⇒ Key	4.14-1
Power Measurements – Hardkey MEAS	4.15-1
Power Measurement in Time Domain.....	4.15-2
Channel and Adjacent-Channel Power Measurements	4.15-7
Setting the Channel Configuration.....	4.15-14
Measurement of Signal Amplitude Statistics	4.15-26
Measurement of Carrier/Noise Ratio C/N and C/N ₀	4.15-32
Measurement of the AM Modulation Depth.....	4.15-34
Measurement of the Third Order Intercept (TOI)	4.15-35

Setup of Limit Lines and Display Lines – LINES Key	4.16-1
Selection of Limit Lines.....	4.16-2
Entry and Editing of Limit Lines	4.16-6
Display Lines	4.16-11
Configuration of Screen Display – DISP Key	4.17-1
Instrument Setup and Interface Configuration – SETUP Key	4.18-1
External Reference.....	4.18-2
External Noise Source	4.18-2
RF Preamplifier.....	4.18-3
Transducer	4.18-3
Activating Transducer Factors.....	4.18-3
Entry and Editing of Transducer Factors.....	4.18-6
Programming the Interface Configuration and Time Setup	4.18-10
Selecting the IEC/IEEE-Bus Address.....	4.18-10
Serial Interface Configuration.....	4.18-12
Setting Date and Time.....	4.18-15
Configuration of Network Settings (with Option FSP-B16 only)	4.18-16
Enabling Firmware Options	4.18-18
Emulation of the Instrument Front Panel.....	4.18-19
System Information.....	4.18-20
Display of Module Data	4.18-21
Display of Device Statistics	4.18-22
Display of System Messages	4.18-23
Service Menu.....	4.18-24
General Service Functions	4.18-25
Selftest	4.18-26
Hardware Adjustment.....	4.18-27
Firmware Update	4.18-27
Saving and Recalling Data Sets – FILE Key	4.19-1
Overview.....	4.19-1
Storing a Device Configuration	4.19-2
Storing a Complete Device Configuration	4.19-2
Storing Parts of a Device Configuration	4.19-2
Loading a Data Set:	4.19-3
Automatic Loading of a Data Set during Booting.....	4.19-4
Copying Data Sets to Disk.....	4.19-4
EnteringText with the Help Line Editor	4.19-5
Description of the Individual Softkeys.....	4.19-6
Operating Concept of File Managers	4.19-13
Measurement Documentation – HCOPY Key	4.20-1
HCOPY menu:.....	4.20-1
Selecting Printer, Clipboard and File Formats.....	4.20-4
File formats.....	4.20-4
Clipboard	4.20-4
Printer	4.20-5
Selecting Alternative Printer Configurations	4.20-6
Selecting Printer Colours	4.20-6
Entering a Text with the Auxiliary Line Editor	4.20-9
Installation of Plug&Play Printers.....	4.20-10
Installation of Non-Plug&Play Printers.....	4.20-10

Local Printer	4.20-11
Network Printer	4.20-15
Tracking Generator - Option FSP-B9	4.21-1
Tracking Generator Settings.....	4.21-2
Transmission Measurement.....	4.21-4
Calibration of Transmission Measurement.....	4.21-5
Normalization.....	4.21-7
Reflection Measurement.....	4.21-11
Calibration of Reflection Measurement	4.21-12
Calibration mechanism	4.21-13
Frequency-Converting Measurements	4.21-14
External Modulation of the Tracking Generator.....	4.21-16
Option External Generator Control - FSP-B10	4.22-1
External Generator Settings	4.22-2
Transmission Measurement.....	4.22-3
Calibration of Transmission Measurement.....	4.22-3
Normalization:.....	4.22-5
Reflection Measurement.....	4.22-9
Calibration of Reflection Measurement	4.22-9
Calibration mechanism	4.22-10
Frequency-converting Measurements	4.22-11
Configuration of an External Generator.....	4.22-12
List of Generator Types Supported by the FSP.....	4.22-14
OPTION LAN Interface.....	4.23-1
Connecting the Instrument to the Network	4.23-1
Installing the Software	4.23-1
Installation of Drivers for the Network Card.....	4.23-1
Configuration of Available Network Protocols (TCP/IP Protocol)	4.23-3
Installation of Further Network Protocols and Services (e.g. Novell Netware Support)..	4.23-6
Examples of Configurations	4.23-8
Subsequent Changing of the Network Configuration (Computer Name, Domain, Workgroup, etc).....	4.23-9
Operating the Instrument without a Network	4.23-10
Operating the Instrument on the Network.....	4.23-11
NOVELL Networks	4.23-11
MICROSOFT Network.....	4.23-11
Defining Users.....	4.23-12
Changing the User Password.....	4.23-14
Login in the Network.....	4.23-17
Disabling the Autologin Mechanism	4.23-17
Reenabling the Autologin Mechanism	4.23-17
Using Network Drives.....	4.23-18
Printing on a Network Printer	4.23-20
Remote Monitoring of R&S FSP via XP Remote Desktop	4.23-25
Introduction.....	4.23-25
Configuration of R&S FSP for Using Remote Desktop	4.23-26
Configuration of Controller	4.23-27
Setting up the Connection with the R&S FSP	4.23-30
Interruption and Re-setup of Remote Desktop Connection with the R&S FSP.....	4.23-32
Switching off the R&S FSP from the Controller.....	4.23-33
Remote Data Transfer with TCP/IP Services.....	4.23-33
File Transfer via FTP	4.23-33

RSIB Protocol	4.23-35
Remote Control via RSIB Protocol	4.23-35
Windows Environment	4.23-35
UNIX Environment.....	4.23-36
RSIB Interface Functions	4.23-37
Overview of Interface Functions	4.23-37
Variables ibsta, iberr, ibcntl	4.23-38
Description of Interface Functions.....	4.23-39
Programming via the RSIB Protocol.....	4.23-45
Visual Basic.....	4.23-45
Visual Basic for Applications (Winword and Excel).....	4.23-48
C / C++	4.23-49
Trigger Port Option – R&S FSP-B28	4.24-1
Description.....	4.24-1
Mechanical Design	4.24-3
Electrical Characteristics	4.24-4

4 Instrument Functions

All functions of the spectrum analyzer and their application are explained in detail in this chapter. The sequence of the described menu groups depends on the procedure selected for the configuration and start of a measurement:

1. Resetting the instrument - *PRESET* key
2. Setting the mode – hotkey bar and *LOCAL* key
3. Setting the measurement parameters - keys *FREQ*, *SPAN*, *AMPT*, *BW*, *SWEEP*, *TRIG*, *TRACE*, *CAL*
4. Selecting and configuring the measurement function - keys *MKR*, *MKR->*, *MKR FCTN*, *MEAS*, *LINES*

The instrument functions for general settings, printout and data management are described at the end of this chapter – keys *DISP*, *SETUP*, *FILE* and *HCOPY*.

The different softkeys of a menu are described from top to bottom and from the left to the right side menu. The submenus are marked by an indentation or displayed in a separate section. The whole path (key - softkey - ...) is indicated in the line above the menu display.

An overview of the menus is given in chapter 3 which also contains the description of the operating concept.

The IEC/IEEE-bus commands (if any) are indicated for each softkey. For a fast overview a list of softkeys with the associated IEC/IEEE-bus commands is given at the end of Chapter 6.

An index at the end of the handbook serves as further help for the user.

FSP Initial Configuration – PRESET Key

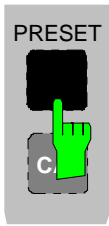

Using the *PRESET* key, the FSP can be set to a predefined initial state.

Notes: *The settings are selected in a way that the RF input is always protected against overload, provided that the applied signal levels are in the allowed range for the instrument.*

The initial instrument state set by the PRESET key can be adapted to arbitrary applications using the STARTUP RECALL function. With this function the STARTUP RECALL dataset is loaded upon pressing the PRESET key. For further information refer to section "Saving and Recalling Data Sets".

Pressing the *PRESET* key causes the FSP to enter its initial state according to the following table:

Table 4-1 Initial State of FSP

Parameter	Settings
Mode	Spectrum
Center frequency)	1,5 GHz / 3,5 GHz / 6,8 GHz / 15 GHz / 20 GHz (FSP-3/-7/-13/-30/-40)
Center frequency step size	0.1 * center frequency
Span	3 GHz / 7 GHz / 13.6 GHz / 30 GHz / 40 GHz (FSP-3/-7/-13/-30/-40)
RF attenuation	auto (10 dB)
Reference level	-20 dBm
Level range	100 dB log
Level unit	dBm
Sweep time	auto
Resolution bandwidth	auto (3 MHz)
Video bandwidth	auto (10 MHz)
FFT filters	off
Span / RBW	50
RBW / VBW	0.33
Sweep	cont
Trigger	free run
Trace 1	clr write
Trace 2/3	blank
Detector	auto peak
Trace math	off
Frequency offset	0 Hz
Reference level offset	0 dB
Reference level position	100 %
Grid	abs
Cal correction	on
Noise source	off
Input	RF
Display	Full screen, active screen A
Tracking generator (only with option FSP-B9)	off
External generator 1/2 (only with option -B10)	off
Preamplifier (only with option -B25)	off
El. Attenuation (only with option -B25)	off

Mode Selection – HOTKEY Bar

For fast mode selection FSP has seven keys (the so-called *HOTKEYS*) which can be allocated depending on the options installed on the instrument.

Two keys are reserved for the basic model:

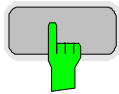
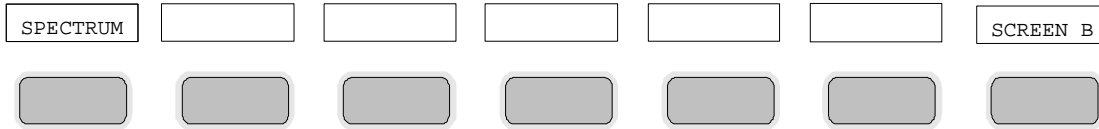

The *SPECTRUM* hotkey sets FSP to spectrum analysis mode.

The spectrum analysis mode is the basic setting of FSP.

IEC/IEEE-bus command: `INST:SEL SAN`

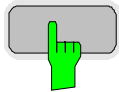

With the *SCREEN A* / *SCREEN B* hotkey two different settings can be selected on the FSP in the FULL SCREEN mode.

In the SPLIT SCREEN mode the key switches between active diagram A and B.

The key designation indicates the diagram which has been activated by means of the key.

The currently active window is marked by **A** or **B** on the right of the diagram.

IEC/IEEE-bus command: `DISP:WIND<1|2>:SEL`

The meaning of the other keys is described in the chapter describing the various options.

Return to manual control – LOCAL Menu

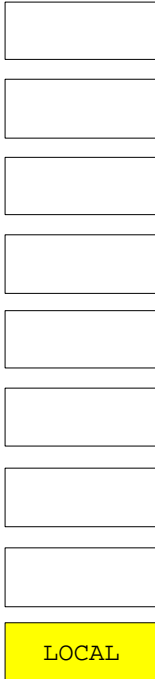

The menu LOCAL is displayed on switching the instrument to remote control mode.

At the same time, the *HOTKEY* bar is blanked out and all keys are disabled except the *PRESET* key. The diagram, traces and display fields are then blanked out (they can be activated using the remote control command `SYSTEM:DISPlay:UPDate ON`).

The menu contains only one softkey, the *LOCAL* key. The *LOCAL* key switches the instrument from remote to manual control, with the assumption that the remote controller has not previously set the *LOCAL LOCKOUT* function.

A change in the control mode consists of:

- **Enabling the Front Panel Keys**

Returning to manual mode enables all inactive keys and turns on the hotkey menu. The soft key menu which is displayed is the main menu of the current mode.

- **Inserting the measurement diagrams**

The blanked diagrams, traces and display fields are inserted.

- **Generating the message OPERATION COMPLETE**

If, at the time of pressing the *LOCAL* softkey, the synchronisation mechanism via `*OPC`, `*OPC?` or `*WAI` is active, the currently running measurement procedure is aborted and synchronisation is achieved by setting the corresponding bits in the registers of the status reporting system.

- **Setting Bit 6 (User Request) of the Event Status Register**

With a corresponding configuration of the status reporting system, this bit immediately causes the generation of a service request (*SRQ*) which is used to inform the control software that the user wishes to return to front-panel control. This information can be used, e.g., to interrupt the control program so that the user can make necessary manual corrections to instrument settings. This bit is set each time the *LOCAL* softkey is pressed.

Note: *If the LOCAL LOCKOUT function is active in the remote control mode, the front-panel PRESET key is also disabled. The LOCAL LOCKOUT state is left as soon as the process controller deactivates the REN line or the IEC/IEEE-bus cable is disconnected from the instrument.*

Spectrum Analyzer Mode

The analyzer mode is activated by pressing hotkey *SPECTRUM* (see also Section 'Mode Selection')

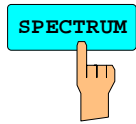

The *SPECTRUM* hotkey selects the *ANALYZER* mode.

This mode is the default setting of the FSP.

The functions provided correspond to those of a conventional spectrum analyzer. The analyzer measures the frequency spectrum of the test signal over the selected frequency range with the selected resolution and sweep time, or, for a fixed frequency, displays the waveform of the video signal.

Note: If two displays (screen A and screen B) are opened after switch-on of signal analysis, the analyzer mode is only set for the display activated for entry (marked at the top right corner of diagram). For the other display, the previous settings remain valid. Data acquisition and display of measured values is sequential: first in the upper and then in the lower display.

Frequency and Span Selection – *FREQ* Key

The *FREQ* key is used to specify the frequency axis of the active display window. The frequency axis can be defined either by the start and stop frequency or by the center frequency and the span (*SPAN* key). With two windows (*SPLIT SCREEN*) displayed at the same time, the input data always refer to the window selected in the *SYSTEM-DISPLAY* menu.

After pressing one of the *CENTER*, *START* or *STOP* softkeys, the value of the corresponding parameter can be defined in an input window.

FREQ menu:

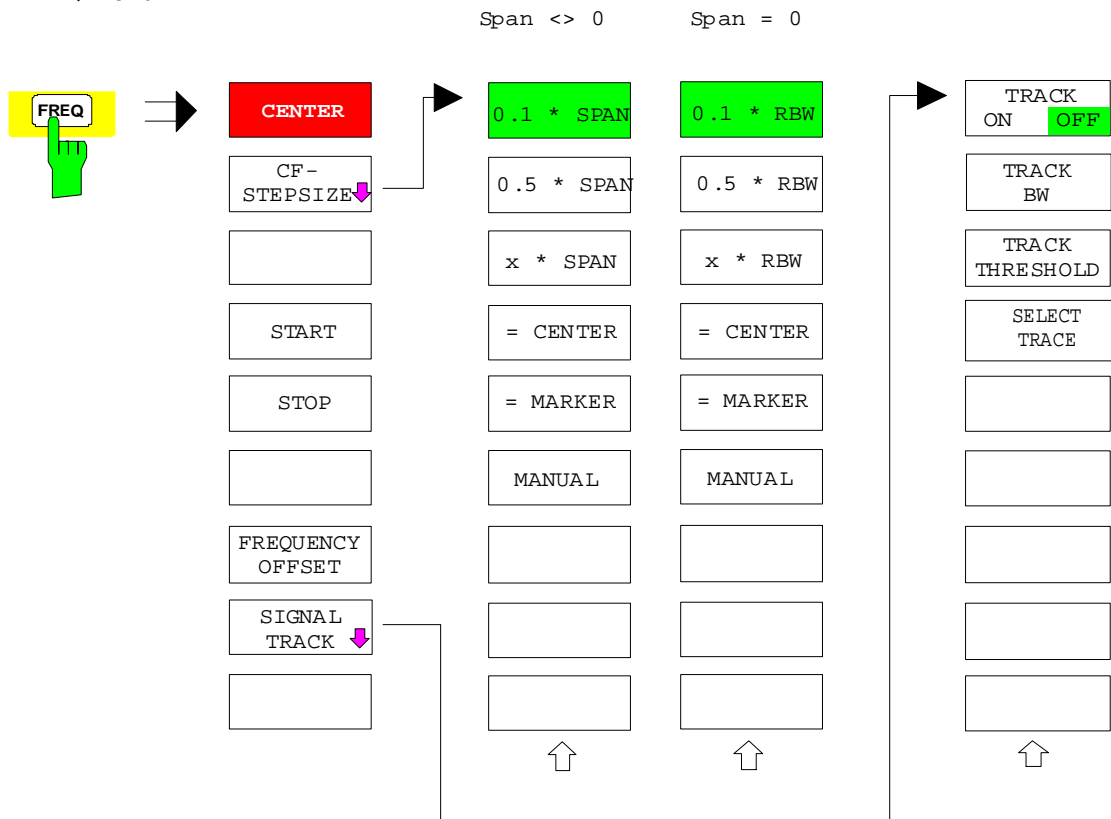



The *CENTER* softkey opens the window for manually entering the center frequency.

The allowed range of values for the center frequency is:

for the frequency domain (span >0):

$$\text{minspan} / 2 \leq f_{\text{center}} \leq f_{\text{max}} - \text{minspan} / 2$$

and for the time domain (span = 0):

$$0 \text{ Hz} \leq f_{\text{center}} \leq f_{\text{max}}$$

f_{center} center frequency
 minspan smallest selectable span > 0 Hz (10 Hz)
 f_{max} max. frequency

IEC/IEEE-bus command: `FREQ:CENT 100MHZ`



The *CF STEPSIZE* softkey opens a submenu for setting the step size of the center frequency. The step size can be coupled to the span (frequency domain) or the resolution bandwidth (time domain) or it can be manually set to a fixed value. The softkeys are mutually exclusive selection keys.

The softkeys are presented according to the selected domain (frequency or time).

Softkeys in frequency domain:

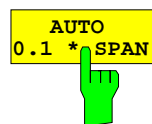

The *0.1 * SPAN* softkey sets the step size for the center frequency entry to 10% of the span.

IEC/IEEE-bus command:
`FREQ:CENT:STEP:LINK SPAN`
`FREQ:CENT:STEP:LINK:FACT 10PCT`

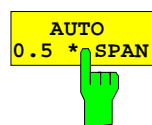

The *0.5 * SPAN* softkey sets the step size for the center frequency entry to 50% of the span.

IEC/IEEE-bus command:
`FREQ:CENT:STEP:LINK SPAN`
`FREQ:CENT:STEP:LINK:FACT 50PCT`

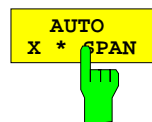

The *X * SPAN* softkey allows the factor defining the center frequency step size to be entered as % of the span.

IEC/IEEE-bus command:
`FREQ:CENT:STEP:LINK SPAN`
`FREQ:CENT:STEP:LINK:FACT 20PCT`

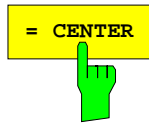

The = *CENTER* softkey sets the step size coupling to *MANUAL* and the step size to the value of the center frequency. This function is especially useful during measurements of the signal harmonic content because by entering the center frequency each stroke of the *STEP* key selects the center frequency of another harmonic.

IEC/IEEE-bus command: --



The = *MARKER* softkey sets the step size coupling to *MANUAL* and the step size to the value of the marker. This function is especially useful during measurements of the signal harmonic content at the marker position because by entering the center frequency each stroke of the *STEP* key selects the center frequency of another harmonic.

IEC/IEEE-bus command: --



The *MANUAL* softkey activates the window for entering a fixed step size.

IEC/IEEE-bus command: `FREQ:CENT:STEP 120MHz`

Softkeys in time domain:

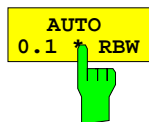

The *0.1 * RBW* softkey sets the step size for the center frequency entry to 10% of the resolution bandwidth.

*AUTO 0.1 * RBW* corresponds to the default setting.

IEC/IEEE-bus command:

```
FREQ:CENT:STEP:LINK RBW
FREQ:CENT:STEP:LINK:FACT 10PCT
```

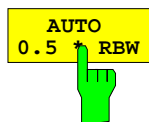

The *0.5 * RBW* softkey sets the step size for the center frequency entry to 50% of the resolution bandwidth.

IEC/IEEE-bus command:

```
FREQ:CENT:STEP:LINK RBW
FREQ:CENT:STEP:LINK:FACT 50PCT
```

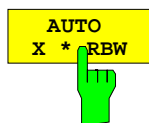

The *X * RBW* softkey allows the factor defining the center frequency step size to be entered as % of the resolution bandwidth.

Values between 1 and 100% in steps of 1% are allowed. The default setting is 10%.

IEC/IEEE-bus command:

```
FREQ:CENT:STEP:LINK RBW
FREQ:CENT:STEP:LINK:FACT 20PCT
```

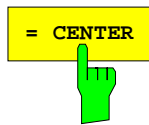

The = *CENTER* softkey sets the step size coupling to *MANUAL* and the step size to the value of the center frequency. This function is especially useful during measurements of the signal harmonic content because by entering the center frequency each stroke of the *STEP* key selects the center frequency of another harmonic.

IEC/IEEE-bus command: --



The = *MARKER* softkey sets the step size coupling to *MANUAL* and the step size to the value of the marker. This function is especially useful during measurements of the signal harmonic content at the marker position because by entering the center frequency each stroke of the *STEP* key selects the center frequency of another harmonic.

IEC/IEEE-bus command: --

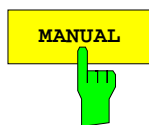

The *MANUAL* softkey activates the window for entering a fixed step size.

IEC/IEEE-bus command: `FREQ:CENT:STEP 120MHz`

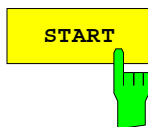

The *START* softkey activates the window for manually entering the start frequency.

The allowed range of values for the start frequency is:

$$0 \text{ Hz} \leq f_{\text{start}} \leq f_{\text{max}} - \text{minspan}$$

f_{start} start frequency
 minspan smallest selectable span (10 Hz)
 f_{max} max. frequency

IEC/IEEE-bus command: `FREQ:STAR 20MHz`

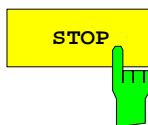

The *STOP* softkey activates the window for entering the .

The allowed range of values for the stop frequency is:

$$\text{minspan} \leq f_{\text{stop}} \leq f_{\text{max}}$$

f_{stop} stop frequency
 minspan smallest selectable span (10 Hz)
 f_{max} max. frequency

IEC/IEEE-bus command: `FREQ:STOP 2000MHz`

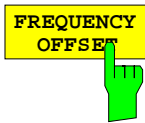

The *FREQUENCY OFFSET* softkey activates the window for entering an arithmetical frequency offset which is added to the frequency axis labelling. The allowed range of values for the offset is -100 GHz to 100 GHz. The default setting is 0 Hz.

IEC/IEEE-bus command: `FREQ:OFFS 10 MHz`



The *SIGNAL TRACK* softkey switches on the tracking of a signal near the center frequency. The signal is tracked as long it is in the search bandwidth around the center frequency defined with *TRACK BW* and above the level threshold defined with *TRACK THRESHOLD*.

For that purpose, the maximum signal is searched (*PEAK SEARCH*) on the screen and the center frequency set to this signal (*MARKER ->CENTER*) after each frequency sweep within the search bandwidth.

If the signal falls below the level threshold or jumps out of the search bandwidth around the center frequency, the center frequency is not varied until a signal is in the search bandwidth above the level threshold. This can be achieved by manually modifying the center frequency, for example.

On switching on, the softkey is highlighted and the search bandwidth and the threshold value are marked on the diagram by two vertical lines and one horizontal line. All these lines are allocated the designation TRK.

At the same time a submenu is opened in which the search bandwidth, the threshold value and the trace can be modified for the maximum search.

The softkey is only available in the frequency domain (span >0).

IEC/IEEE-bus command: `CALC:MARK:FUNC:STR OFF`

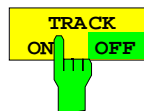

The *TRACK ON/OFF* softkey switches on and off signal tracking.

IEC/IEEE-bus command: `CALC:MARK:FUNC:STR OFF`

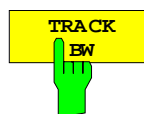

The *TRACK BW* softkey defines the search bandwidth for signal tracking. The frequency range is symmetrical with respect to the center frequency.

IEC/IEEE-bus command:

`CALC:MARK:FUNC:STR:BAND 10KHZ`



The *TRACK THRESHOLD* softkey defines the threshold value for signal detection. The value is always entered as an absolute level value.

IEC/IEEE-bus command:

`CALC:MARK:FUNC:STR:THR -70DBM`

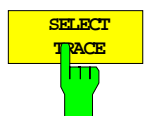

The *SELECT TRACE* softkey selects the trace on which signal tracking is to be performed.

IEC/IEEE-bus command:

`CALC:MARK:FUNC:STR:TRAC 1`

Setting the Frequency Span – SPAN Key

SPAN menu

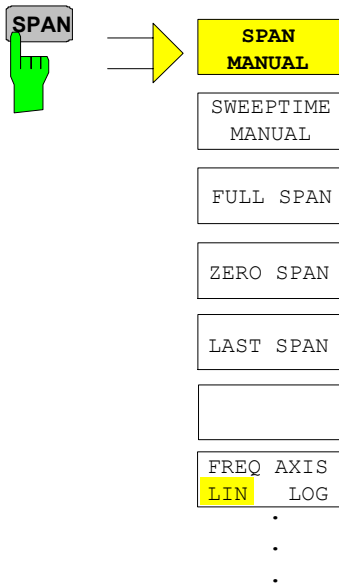

The *SPAN* key opens a menu which offers various options for setting the span.
 The entry of the span (*SPAN MANUAL* softkey) is automatically active for span > 0 Hz.
 For span = 0 Hz the entry for sweep time (*SWEEPTIME MANUAL*) is automatically active.
 With two windows (*SPLIT SCREEN*) displayed at the same time, the input data always refer to the window selected with hotkey *SCREEN A/B*.

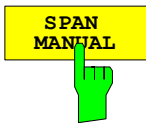

The *SPAN MANUAL* softkey activates the window for manually entering the frequency span. The center frequency is kept constant.

The allowed range of span values is for the time domain (span = 0): 0 Hz and for the frequency domain (span >0): $minspan \leq f_{span} \leq f_{max}$

f_{span} frequency span
 $minspan$ smallest selectable span (10 Hz)
 f_{max} max. frequency

IEC/IEEE-bus command `FREQ:SPAN 2GHz`

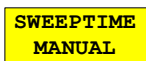

The *SWEEPTIME MANUAL* softkey activates the window for entering the sweep time manually with Span = 0 Hz. The softkey is not available for Span > 0 Hz.

IEC/IEEE-bus command: `SWE:TIME 10s`

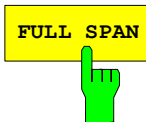

The *FULL SPAN* softkey sets the span to the full frequency range of FSP.

IEC/IEEE-bus command `FREQ:SPAN:FULL`



The *ZERO SPAN* softkey sets the span to 0 Hz. The x axis becomes the time axis with the grid lines corresponding to 1/10 of the current sweep time (SWT).

IEC/IEEE-bus command `FREQ:SPAN 0Hz`



After changing the span setting the *LAST SPAN* softkey activates the previous setting. With this function a fast change between overview measurement (*FULL SPAN*) and detailed measurement (manually set center frequency and span) is possible.

Note: Only values > 0 Hz are restored, i.e. a transition between time and frequency domain is not possible.

IEC/IEEE-bus command ---

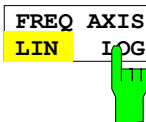

The *FREQ AXIS LIN/LOG* softkey switches between linear and logarithmic scaling of the frequency axis. Switchover is only possible if the stop/start frequency ratio is ≥ 10 .

IEC/IEEE-bus command SWE:SPAC LIN

Level Display Setting and RF Input Configuration – AMPT Key

The *AMPT* key is used to set the reference level, the maximum level and the display range of the active window as well as the input impedance and the input attenuation of the RF input.

The *AMPT* key opens a menu for setting the reference level and the input attenuation of the active window. The data entry for the reference level (*REF LEVEL* softkey) is opened automatically.

Further settings regarding level display and attenuation can be made in this menu.

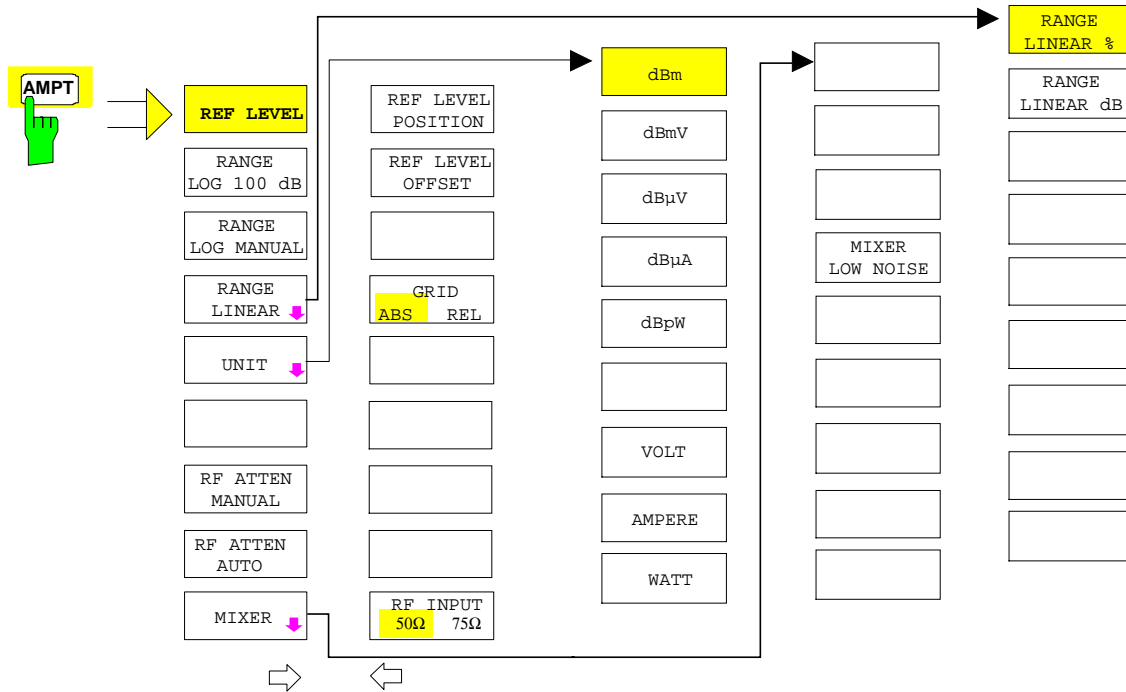

The *REF LEVEL* softkey allows the reference level to be input in the currently active unit (dBm, dB μ V, etc).

IEC/IEEE-bus command: `DISP:WIND:TRAC:Y:RLEV -60dBm`

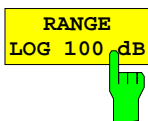

The *RANGE LOG 100 dB* softkey sets the level display range to 100 dB.

IEC/IEEE-bus command: `DISP:WIND:TRAC:Y:SPAC LOG`
`DISP:WIND:TRAC:Y 100DB`

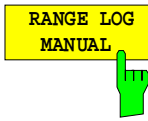

The *RANGE LOG MANUAL* softkey activates the manual entry of the level display range. Display ranges from 10 to 200 dB are allowed in 10 dB steps. Inputs which are not allowed are rounded to the next valid value.

The default setting is 100 dB.

IEC/IEEE-bus command: `DISP:WIND:TRAC:Y:SPAC LOG`
 `DISP:WIND:TRAC:Y 120DB`

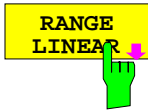

The *RANGE LINEAR* softkey selects linear scaling for the level display range of the analyzer. In addition, it opens a submenu for selecting % or dB for the scaling.

When linear scaling is selected, the % scaling is first activated (see also *RANGE LINEAR dB* softkey).

IEC/IEEE-bus command: `DISP:WIND:TRAC:Y:SPAC LIN`

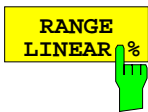

The *RANGE LINEAR %* softkey selects linear scaling in % for the level display range, i.e. the horizontal lines are labelled in %. The grid is divided in decadic steps. Markers are displayed in the selected unit; delta markers are displayed in % referenced to the voltage value at the position of marker 1.

IEC/IEEE-bus command: `DISP:WIND:TRAC:Y:SPAC LIN`

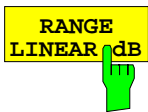

The *RANGE LINEAR dB* softkey selects linear scaling in dB for the level display range, i.e. the horizontal lines are labelled in dB. Markers are displayed in the selected unit; delta markers are displayed in dB referenced to the power value at the position of marker 1.

IEC/IEEE-bus command: `DISP:WIND:TRAC:Y:SPAC LDB`

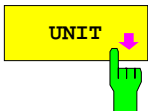

- dBm**
- dBmV
- dBμV
- dBμA
- dBpW
-
- VOLT
- AMPERE
- WATT

The *UNIT* softkey opens a sub menu allowing to select the unit for the level axis.

The default setting is dBm.

In general, the spectrum analyzer measures the signal voltage at the RF input. The level display is calibrated in rms values of an unmodulated sinewave signal. In the default state, the level is displayed at a power of 1 mW (= dBm). Via the known input resistance of 50 Ω or 75Ω , conversion to other units is possible. The units dBm, dBmV, dBμV, dBμA, dBpW, V, A and W are directly convertible.

IEC/IEEE-bus command: `CALC:UNIT:POW DBM`

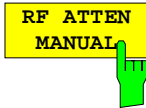

The *RF ATTEN MANUAL* softkey allows the attenuation to be entered irrespective of the reference level.

The attenuation can be set in 10 dB steps between 0 and 70 dB (in 5 dB steps between 0 and 75 dB if option *-B25, Electronic Attenuator*, is fitted).

If the defined reference level cannot be set for the given RF attenuation, the reference level will be adjusted accordingly and the warning "Limit reached" will be output.

Note: *The 0 dB value can be entered only via the numeric keypad in order to protect the input mixer against overload.*

IEC/IEEE-bus command: `INP:ATT 40 DB`

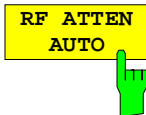

The *RF ATTEN AUTO* softkey sets the RF attenuation automatically as a function of the selected reference level.

This ensures that the optimum RF attenuation desired by the user is always used.

RF ATTEN AUTO is the default setting.

IEC/IEEE-bus command: `INP:ATT:AUTO ON`



The *MIXER LEVEL* softkey opens the submenu for changing the mixer level at the input mixer.

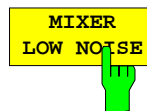

The *MIXER LOW NOISE* softkey changes the operating point of the input mixer so that (with the RF attenuation remaining the same) the inherent noise of the analyzer is reduced compared to the default setup.

Notes:

- The function is not available for models 3 and 7.
- The modified operating point of the input mixer will be effective only if the start frequency of the analyzer is ≥ 3 GHz.
- In the default setting, the function is switched off.

IEC/IEEE-bus command: `INP:ATT:AUTO:MODE LNOI`

AMPT – NEXT menu:



The *REF LEVEL POSITION* softkey allows the reference level position to be entered.

The setting range is from -200 to +200%, 0% corresponding to the lower and 100% to the upper limit of the diagram.

IEC/IEEE-bus command: `DISP:WIND:TRAC:RPOS 100PCT`



The *REF LEVEL OFFSET* softkey allows the arithmetic level offset to be entered. This offset is added to the measured level irrespective of the selected unit. The scaling of the Y axis is changed accordingly.

The setting range is ± 200 dB in 0.1 dB steps.

IEC/IEEE-bus command: `DISP:WIND:TRAC:RLEV:OFFS -10dB`

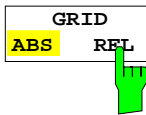

The *GRID ABS/REL* softkey switches between absolute and relative scaling of the level axis.

GRID ABS is the default setting.

ABS The labelling of the level lines refers to the absolute value of the reference level.

REL The upper line of the grid is always at 0 dB.
The scaling is in dB whereas the reference level is always in the set unit (dBm, dB μ V,...).

For setting *RANGE LINEAR* (linear scaling, labelling of axes in %) the softkey is not displayed since the unit % itself implies a relative scale.

IEC/IEEE-bus command: `DISP:WIND:TRAC:Y:MODE ABS`

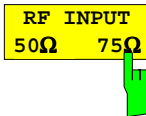

The *RF INPUT 50 Ω / 75 Ω* softkey switches the input impedance of the instrument between 50 Ω (= default setting) and 75 Ω .

The setting 75 Ω should be used if the input impedance (50 Ω) is transformed to 75 Ω using the corresponding adapter unit of type RAZ (= 25 Ω in series to the input impedance of the analyzer). The correction value used for the adaption is 1.76 dB = 10 log (75 Ω / 50 Ω).

All levels specified in this operating manual refer to the default setting of the instrument (50 Ω).

IEC/IEEE-bus command: `INP:IMP 50OHM`

Electronic Attenuator

Besides the mechanical attenuator at the RF input, the FSP also offers an electronic attenuation setting (option *ELECTRONIC ATTENUATOR FSP-B25*). The attenuation range is 0 to 30 dB, with the default attenuation being preset by the mechanical attenuator.

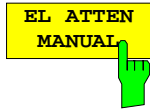

The *EL ATTEN MANUAL* softkey switches the electronic attenuator on and allows the attenuation of the electronic attenuator to be set.

The attenuation can be varied in 5 dB steps from 0 to 30 dB. Other entries are rounded to the next lower integer value.

If the defined reference level cannot be set for the given RF attenuation, the reference level will be adjusted accordingly and the warning "Limit reached" will be output.

IEC/IEEE-bus command: INP:EATT:AUTO OFF
 INP:EATT 10 DB

This function is only available with option *ELECTRONIC ATTENUATOR -B25*.



The *EL ATTEN AUTO* softkey switches the electronic attenuator on and automatically sets its attenuation to 0 dB.

The allowed setting range of the reference level ranges from the current reference level on switching on the electronic attenuator to over 30 dB. If a reference level is set outside the allowed 30-dB range, setting is performed by means of the mechanical attenuator. From this new reference level to over 30 dB the setting is again performed with the electronic attenuator.

IEC/IEEE-bus command: INP:EATT:AUTO ON

This function is only available with option *ELECTRONIC ATTENUATOR -B25*.



The *EL ATTEN OFF* softkey switches the electronic attenuator off.

IEC/IEEE-bus command: INP:EATT:STAT OFF

This function is only available with option *ELECTRONIC ATTENUATOR -B25*.

Setting the Bandwidths and Sweep Time – *BW* Key

The *BW* key calls a menu for setting the resolution bandwidth (*RBW*), video bandwidth (*VBW*) and sweep time (*SWT*) for the frequency sweep. The parameters may be coupled dependent on the span (stop minus start frequency) or freely set by the user. When working with a split screen display, the settings always refer to the active window.

The FSP offers resolution bandwidths from 10 Hz to 10 MHz in 1, 3, 10 steps:

Resolution bandwidths up to 100 kHz are realized using digital bandpasses with Gaussian characteristics. As far as the attenuation characteristic is concerned they behave like analog filters but have a much higher measurement speed than comparable analog filters. This is due to the fact that the transient response can be compensated as a result of an accurately defined filter behaviour.

Bandwidths above 100 kHz are realized using decoupled 4-circuit LC filters.

As an alternative to the analog filters, FFT filters are available for the bandwidths between 1 Hz and 30 kHz. When working with bandwidths up to 30 kHz, the FFT algorithm offers considerably higher measurement speeds with all the other settings remaining the same. The reason is that with analog filters the sweep time required for a particular span is proportional to $(\text{Span}/\text{RBW}^2)$. When using the FFT algorithm, however, the sweep time is proportional to (Span/RBW) .

The video bandwidths are available in 1, 3, 10 steps between 1 Hz and 10 MHz. They can be set in accordance with the resolution bandwidth.

The video filters serve for smoothing the displayed trace. Video bandwidths that are small compared to the resolution bandwidth average out noise peaks and pulsed signals, so that only the signal average is displayed. If pulsed signals are to be measured, it is recommended to use a video bandwidth that is large compared to the resolution bandwidth ($\text{VBW} \geq 10 \times \text{RBW}$) for the amplitudes of pulses to be measured correctly.

Note: *For analog and digital filters, the FSP has overload reserves of different magnitude above the reference level. Due to the LO breakthrough the overload display OVLD responds with digital filters with $\text{RBW} < 100$ kHz, as soon as the start frequency is selected $< 6 \times$ resolution bandwidth, for $\text{RBW} = 100$ kHz, as soon as the start frequency is below 3 MHz.*

BW menu:

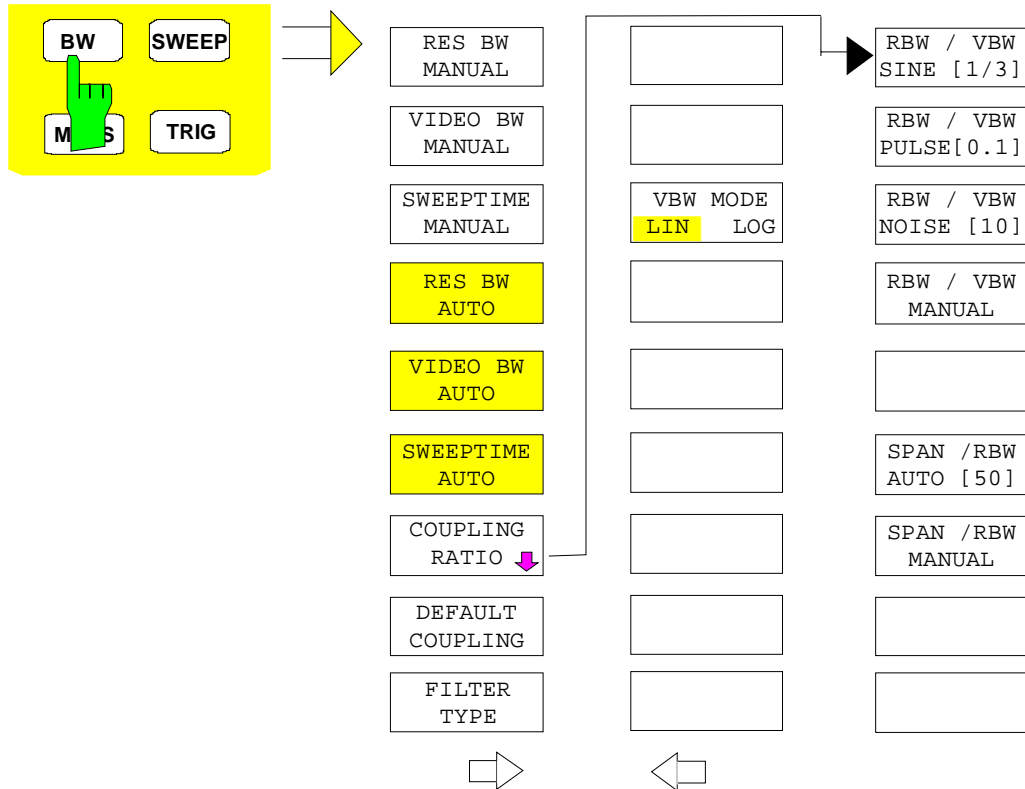

The *BW* key opens a menu for setting the resolution bandwidth, the video bandwidth, the sweep time and their couplings.

The .. *BW AUTO* softkeys are used to couple the functions. The coupling ratios are selected by means of the *COUPLING RATIO* softkey.

The .. *BW MANUAL* softkeys allow a parameter to be entered. This parameter is not coupled to the other parameters.

Note: *With the ... BW AUTO softkeys the resolution bandwidth, the video bandwidth and the sweep time can be entered separately for the frequency domain (span > 0 Hz) and the time domain (span = 0 Hz). But with ...BW MANUAL softkeys the selected values apply to both the frequency and time domain.*

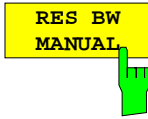

The *RES BW MANUAL* softkey activates the manual data entry for the resolution bandwidth.

The resolution bandwidth can be selected in 1/3/10 steps in the range between 10 Hz and 10 MHz. The nominal resolution bandwidth is the 3 dB bandwidth.

When FFT filters are used, the lower limit of the bandwidth is 1 Hz. FFT filters may be used with bandwidths up to 30 kHz.

For numeric inputs, the values are always rounded to the nearest possible bandwidth. For rollkey or UP/DOWN key inputs, the bandwidth is adjusted in steps either upwards or downwards.

For filter type CHANNEL or RRC the bandwidth is selected from the list of available channel filters given at the end of this chapter. For data entry, the cursor keys ↑ and ↓ scroll through this list.

The manual input mode of the resolution bandwidth is indicated by a green terisk (*) on the display.

IEC/IEEE-bus command: BAND:AUTO OFF;
 BAND 1MHz



The *VIDEO BW MANUAL* softkey activates the manual data entry for the video bandwidth.

The video bandwidth can be selected in 1/3/10 steps in the range between 1 Hz and 10 MHz.

For numeric inputs, the values are always rounded to the nearest possible allowed bandwidth. For rollkey or UP/DOWN key inputs, the bandwidth is adjusted in steps either downwards or upwards.

The manual input mode of the video bandwidth is indicated by a green terisk (*) on the display.

IEC/IEEE-bus command: BAND:VID:AUTO OFF;
 BAND:VID 10 kHz

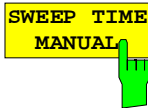

The *SWEPTIME MANUAL* softkey activates the manual data entry for the sweep time. At the same time, the coupling of the sweep time is cancelled. Other couplings (*VIDEO BW*, *RES BW*) remain effective.

In the frequency domain (span > 0 Hz) and for resolution bandwidths above 1 kHz, the allowed sweep times for spans > 3.2 kHz range from 2.5 ms through to 16000 s. With spans below 3.2 kHz, the maximum allowed sweep time is reduced to $5 \text{ s} * \text{span/Hz}$.

If FFT filters are used, the sweep time is fixed by the span and the bandwidth and therefore cannot be set.

In time domain (span = 0 Hz), the range of sweep times is 1 μs to 16000 s is selectable in steps of max. 5% of the sweep time. For numeric inputs, rounding is made to the nearest possible sweep time. For rollkey or UP/DOWN key inputs, the sweep time is adjusted in steps either downwards or upwards.

The manual input mode of the sweep time is indicated by a green asterisk (*) on the display. If the selected sweep time is too short for the selected bandwidth and span, level measurement errors will occur. This happens because the available settling time for the resolution or video filters is too short. In this case, the FSP outputs *UNCAL* on the display and marks the indicated sweep time with a red asterisk (*).

IEC/IEEE-bus command: `SWE:TIME:AUTO OFF;`
 `SWE:TIME 10s`

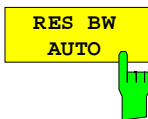

The *RES BW AUTO* softkey couples the resolution bandwidth to the selected span. Changing the span causes automatic adjustment of the resolution bandwidth.

Automatic coupling of resolution bandwidth to span is always recommended when a favourable setting of the resolution bandwidth in relation to the selected span is desired for the measurement under request.

The coupling ratio is set in the *COUPLING RATIO* submenu.

The *RES BW AUTO* softkey is only available in the frequency domain (span > 0 Hz). The softkey is blanked in the time domain.

IEC/IEEE-bus command: `BAND:AUTO ON`

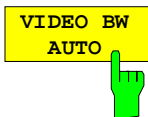

The *VIDEO BW AUTO* softkey couples the video bandwidth to the resolution bandwidth. If the resolution bandwidth is changed, the video bandwidth is automatically adjusted.

The coupling of the video bandwidth is always recommended when the minimum sweep time is required for a selected resolution bandwidth. Narrower video bandwidths require longer sweep times due to the longer settling time. Wider bandwidths reduce the signal/noise ratio.

The coupling ratio is set in the *COUPLING RATIO* submenu.

The coupling of the video bandwidth to the resolution filter is also permitted for the time domain display (span = 0).

IEC/IEEE-bus command: `BAND:VID:AUTO ON`

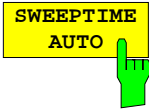

The *SWEPTIME AUTO* softkey couples the sweep time to the span, video bandwidth (VBW) and resolution bandwidth (RBW). The sweep time is automatically adjusted on any change in span, resolution bandwidth or video bandwidth.

The softkey is only available in the frequency domain (span >0 Hz). It is blanked in the time domain.

The FSP always selects the shortest sweep time possible without falsifying the signal. The maximum level error compared to using a longer sweep time is < 0.1 dB. If additional bandwidth and level errors are to be avoided, the sweep time is to be set to three times the time offered in coupled mode.

IEC/IEEE-bus command: `SWE:TIME:AUTO ON`

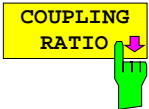

RBW / VBW
SINE [1/3]

The *COUPLING RATIO* softkey opens a sub menu for selection of the coupling ratios.

RBW / VBW
PULSE [.1]

When the default setting is active, i.e. the *COUPLING RATIO* softkey is deactivated (not highlighted), the ratio span/resolution bandwidth (SPAN/RBW) is 50 (this corresponds to SPAN / RBW AUTO [50]) and the ratio resolution bandwidth/video bandwidth (RBW/VBW) is 0.33 (this corresponds to RBW / VBW SINE [1/3]).

RBW / VBW
NOISE [10]

RBW / VBW
MANUAL

If the ratio RBW/VBW or SPAN/RBW is different from the default setting, the *COUPLING RATIO* softkey is highlighted.

SPAN / RBW
AUTO [50]

The softkeys RBW/VBW... are selection keys. Only one softkey can be enabled at any one time. The softkeys are only effective for the *VBW AUTO* selection in the main menu.

SPAN / RBW
MANUAL

The softkeys SPAN/RBW... are also selection keys. They are only effective for the *RBW AUTO* selection in the main menu.

RBW / VBW
SINE [1/3]

The *RBW/VBW SINE [1/3]* softkey sets the following coupling ratio:
video bandwidth = 3 x resolution bandwidth.

This is the default setting for the coupling ratio resolution bandwidth/video bandwidth.

This is the coupling ratio recommended if sinusoidal signals are to be measured.

IEC/IEEE-bus command `BAND:VID:RAT 3`

This setting is only effective for the *VBW AUTO* selection in the main menu.

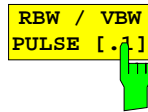

The *RBW/VBW PULSE [0.1]* softkey sets the following coupling ratio:

video bandwidth = 10 x resolution bandwidth or
video bandwidth = 10 MHz (= max. VBW).

This coupling ratio is recommended whenever the amplitudes of pulsed signals are to be measured correctly. The IF filter is exclusively responsible for pulse shaping. No additional evaluation is performed by the video filter.

IEC/IEEE-bus command `BAND:VID:RAT 10`

This setting is only effective for the *VBW AUTO* selection in the main menu.

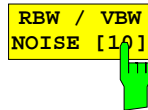

The *RBW/VBW NOISE [10]* softkey sets the following coupling ratio:

video bandwidth = resolution bandwidth/10

At this coupling ratio, noise and pulsed signals are suppressed in the video domain. For noise signals, the average value is displayed.

IEC/IEEE-bus command `BAND:VID:RAT 0.1`

This setting is only effective for the *VBW AUTO* selection in the main menu.

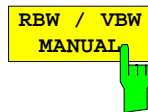

The *RBW/VBW MANUAL* softkey activates the manual input of the coupling ratio.

The resolution bandwidth/video bandwidth ratio can be set in the range 0.001 to 1000.

IEC/IEEE-bus command `BAND:VID:RAT 10`

This setting is only effective for the *VBW AUTO* selection in the main menu.

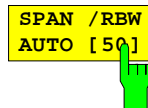

The *SPAN/RBW AUTO [50]* softkey sets the following coupling ratio:

resolution bandwidth = span/50

This coupling ratio is the default setting of the FSP

IEC/IEEE-bus command `BAND:RAT 0.02`

This setting is only effective for the *RBW AUTO* selection in the main menu.

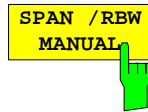

The *SPAN/RBW MANUAL* softkey activates the manual input of the coupling ratio.

The span / resolution bandwidth ratio can be set in the range 1 to 10000.

IEC/IEEE-bus command `BAND:RAT 0.1`

This setting is only effective for the *RBW AUTO* selection in the main menu.

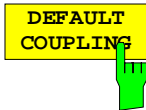

The *DEFAULT COUPLING* softkey sets all coupled functions to the default state (*AUTO*). In addition, the ratio *RBW/VBW* is set to *SINE [1/3]* and the ratio *SPAN/RBW* to 50 in the *COUPLING RATIO* submenu (default setting, *COUPLING RATIO* softkey not highlighted).

IEC/IEEE-bus command `BAND:AUTO ON`
 `BAND:VID:AUTO ON`
 `SWE:TIME:AUTO ON`

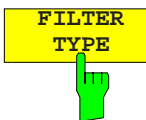

The *FILTER TYPE* softkey opens the selection list for different filter types. In the range up to 30 kHz digital band filters with Gaussian characteristic and filtering with FFT algorithm can be selected.

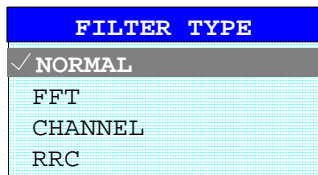

NORMAL For resolution bandwidths up to 100 kHz digital bandpasses are used.

FFT An FFT is performed. For that purpose, the filtered IF signal is digitized and then transformed into the spectral domain via FFT. The transformation range depends on the selected filter bandwidths and can be set between 4 kHz to 50 kHz. If the span is larger than the transformation range, several transformations are performed and the results are appended to each other in the spectral domain.

If the span is smaller than the transformation range, the measurement results are interpolated when the number of measurement points provided by the FFT is smaller than the number of display points in x-direction (501). A flattop window serves as a window in the time domain so that high amplitude precision with good selection is achieved.

A flat-top window serves as a window in the time domain so that high amplitude accuracy as well as good selection are achieved.

Sweep time	Defined by the selected bandwidth and span (reason: FFT filtering is a block transformation). It cannot be changed (softkey deactivated).
Detector	Sample detector and peak detector are available. Peak detector is active when AUTO SELECT is selected.
Video bandwidth	Not defined in case of FFT; therefore cannot be set (softkeys deactivated).

Compared to bandpasses, FFT filters lead to significantly reduced sweep times. For a span of 50 kHz and a bandwidth of 100 Hz, for instance, the sweep time is reduced from 5 s to 40 ms. FFT filters are particularly suitable for stationary signals (sinusoidal signals or signals that are continuously modulated in time). For burst signals (TDMA) or pulsed signals, normal filters are preferable.

Note:

As soon as the FFT filters are active ($RBW \leq 30$ kHz) the sweep time display field (SWT) is replaced by the acquisition time (AQT) display field.

FFT is a block transformation so the result depends on the time relation between the data set to be transformed and the burst or pulsed signal. A gated sweep measurement for TDMA signals is therefore not provided if FFT filters are used.

When the tracking generator (option FSP-B9) is used as signal source for the DUT, filtering with the FFT algorithm is not useful. The selection FFT is thus not available if the tracking generator is switched on..

Additionally, a number of especially steep-edged channel filters are available for power measurement since firmware version 1.10.

A distinction is made between the following filter types:

CHANNEL = general, steep-edged channel filters
 RRC = filters with root-raised cosine characteristic
 (RRC = Root Raised Cosine)

When selecting these filter types, the automatic coupling of the resolution bandwidth to the span is not available. The filters are selected via the *RES BW* softkey.

A list of all available channel filters with their associated applications can be found at the end of this chapter.

IEC/IEEE-bus command: BAND:TYPE NORM

List of available channel filters

The channel filters included in the following table are can be activated via the *FILTER TYPE* softkey and are then available as resolution filters (softkey *RES* available for firmware version 1.10 or higher. They *BW*).

Note:

For filters of type *RRC* (Root Raised Cosine), the filter bandwidth indicated describes the sampling rate of the filter.

For all other filters (*CFILter*) the filter bandwidth is the 3 dB bandwidth.

Filter Bandwidth	Filter Type	Application
100 Hz 200 Hz 300 Hz 500 Hz	CFILter CFILter CFILter CFILter	A0
1 kHz 1.5 kHz 2 kHz 2.4 kHz 2.7 kHz 3 kHz 3.4 kHz 4 kHz 4.5 kHz 5 kHz 6 kHz 8.5 kHz 9 kHz	CFILter CFILter CFILter CFILter CFILter CFILter CFILter CFILter CFILter CFILter CFILter CFILter CFILter	SSB DAB, Satellite ETTS300 113 (12.5 kHz channels) AM Radio
10 kHz 12.5 kHz 14 kHz 15 kHz 16 kHz 18 kHz, $\alpha=0.35$ 20 kHz 21 kHz 24.3 kHz, $\alpha=0.35$ 25 kHz 30 kHz 50 kHz	CFILter CFILter CFILter CFILter RRC CFILter CFILter RRC CFILter CFILter CFILter	CDMAone ETTS300 113 (20 kHz channels) ETTS300 113 (25 kHz channels) TETRA PDC IS 136 CDPD, CDMAone
100 kHz 150 kHz 192 kHz 200 kHz 300 kHz 500 kHz	CFILter CFILter CFILter CFILter CFILter	FM Radio PHS J.83 (8-VSB DVB, USA)
1.0 MHz 1.2288 MHz 1.5 MHz 2.0 MHz *) 3.0 MHz *) 3.84 MHz, $\alpha=0.22$ *) 4.096 MHz, $\alpha=0.22$ *) 5.0 MHz *)	CFILter CFILter CFILter CFILter CFILter RRC RRC CFILter	CDMAone CDMAone DAB W-CDMA 3GPP W-CDMA NTT DOCoMo

*) This filter is available with modification index > 2 of the IF filter module (see softkey *SETUP* - *SYSTEM INFO* - *HARDWARE INFO*).

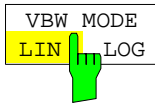

The *VBW MODE LIN/LOG* softkey determines the position of the video filter in the signal path for resolution bandwidths ≤ 100 kHz:

- If LINear is selected, the video filter will be in front of the logarithmic amplifier (default).
- If LOGarithmic is selected, the video filter will be behind the logarithmic amplifier.

The essential difference between the two operating modes relates to the settling in the case of falling signal edges:

With LINear, the falling signal edge will be "flatter" than with LOGarithmic. This is due to the conversion from linear power to logarithmic level units: a reduction of the linear power by 50% reduces the logarithmic signal level by only 3 dB.

IEC/IEEE-bus-command: BAND:VID:TYPE LIN

Sweep Settings – SWEEP Key

The SWEEP key serves for configuring the sweep mode.

SWEEP menu

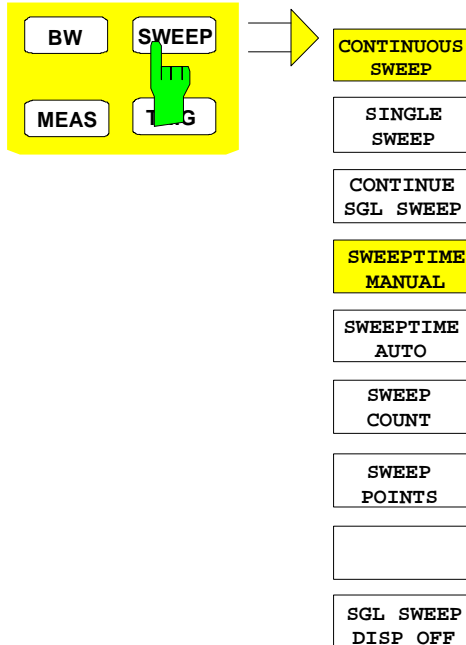

The *SWEEP* key calls a menu in which the sweep mode is defined. In split-screen mode, the entries made are valid for the active window only.

The *CONTINUOUS SWEEP*, *SINGLE SWEEP* and *SGL SWEEP DISP OFF* softkeys are mutually exclusive selection keys.



The *CONTINUOUS SWEEP* softkey activates the continuous sweep mode, which means that the sweep takes place continuously according to the trigger mode set.

When working in the split-screen mode and with different settings in the two windows, screen A is swept first, followed by screen B. When the softkey is pressed, the sweep is restarted.

CONTINUOUS SWEEP is the default setting of FSP.

IEC/IEEE-bus command: INIT:CONT ON

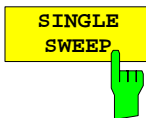

The *SINGLE SWEEP* softkey starts n sweeps after triggering. The number of sweeps is determined by the *SWEEP COUNT* softkey.

When working in the split-screen mode, the frequency ranges of the two windows are swept one after the other.

If a trace is swept using *TRACE AVERAGE* or *MAXHOLD*, the value set via the *SWEEP COUNT* softkey determines the number of sweeps. If 0 has been entered, one sweep is performed.

IEC/IEEE-bus command: INIT:CONT OFF



The *CONTINUE SGL SWEEP* softkey repeats the number of sweeps set under *SWEEP COUNT*, however without first deleting the trace.

This is particularly of interest when using the functions *TRACE AVERAGE* and *MAXHOLD*, if previously recorded measurement results are to be taken into consideration for averaging / maximum search.

If *SGL SWEEP DISP OFF* is active, the screen is switched off also during repeated sweeps.

IEC/IEEE-bus command: INIT:CONM



The *SWEPTIME MANUAL* softkey activates the window for entering the sweep time manually (see also BW menu).

IEC/IEEE-bus command: SWE:TIME 10s

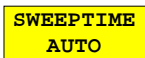

The *SWEPTIME AUTO* softkey activates the automatic selection of the sweep time as a function of the bandwidth of the resolution and video filters (see also BW menu).

IEC/IEEE-bus command: SWE:TIME:AUTO ON



The *SWEEP COUNT* softkey activates the window for the entry of the number of sweeps to be performed by FSP after a single sweep has been started. If Trace Average, Max Hold or Min Hold is activated, this also determines the number of averaging or maximum search procedures.

Example:

[TRACE1: MAX HOLD]

[SWEEP: SWEEP COUNT: {10} ENTER]

[SINGLE SWEEP]

FSP performs the Max Hold function over 10 sweeps.

The permissible range for the sweep count is 0 to 32767. For sweep count = 0 or 1, one sweep is performed. For trace averaging in the continuous-sweep mode, FSP performs running averaging over 10 sweeps if sweep count = 0; if sweep count = 1, no averaging is performed.

The sweep count is valid for all the traces in a diagram.

Note: *The number of sweeps set in the TRACE menu is the same as that in the SWEEP menu.*

If SINGLE SWEEP is selected, the measurement stops after the selected number of sweeps has been performed.

IEC/IEEE-bus command: SWE:COUN 64

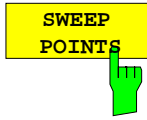

The *SWEEP POINTS* softkey selects the number of measurement samples acquired during a sweep.

The following numbers of points per sweep are available: 155, 313, 625 (default), 1251, 2501, 5001, 10001

Note:

The autopeak detector will be disabled while the number of points per sweep is \neq 625.

EC/IEEE-bus command: SWE:POIN 625

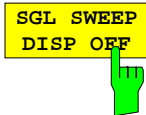

The *SGL SWEEP DISP OFF* softkey deactivates the display while a single sweep is being performed. Once the sweep has been completed, the trace is shown.

IEC/IEEE-bus command: INIT:DISP OFF;:INIT

Triggering the Sweep – TRIG Key

The *TRIG* key opens a menu for selection of the various trigger sources, trigger polarity and external gate function. The active trigger mode is indicated by highlighting the corresponding softkey.

For video trigger, a trigger threshold can be entered, which is represented in the diagram as a horizontal line.

To indicate that a trigger mode other than *FREE RUN* has been set, the enhancement label **TRG** is displayed on the screen. If two windows are displayed, TRG appears next to the appropriate window.

The option *TV and RF Trigger (FSP-B6)* adds a number of trigger functions for the analysis of TV signals to this menu (see section Option FSP-B6 – TV and RF Trigger).

TRIGGER menu

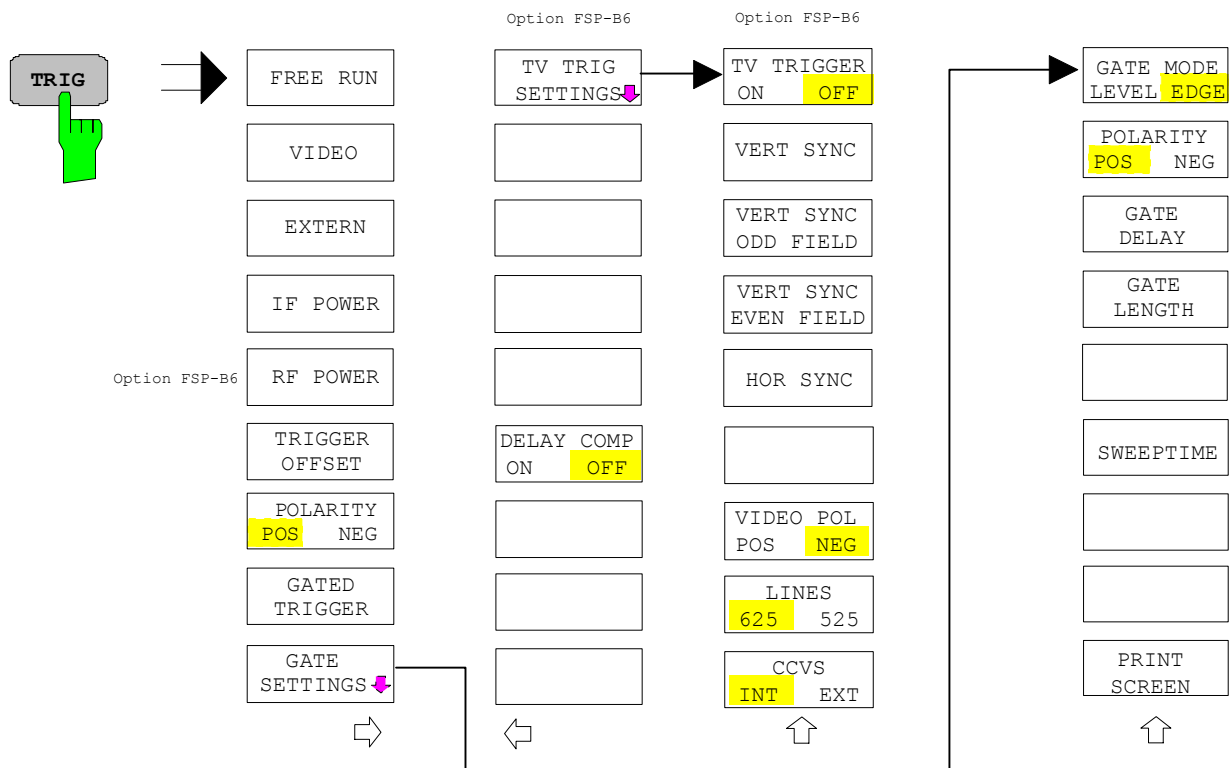

The *FREE RUN* softkey activates the free-run sweep mode, i.e. start of a sweep is not triggered. Once a measurement is completed, another is started immediately.

FREE RUN is the default setting of FSP.

IEC/IEEE-bus command: `TRIG:SOUR IMM`

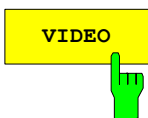

The *VIDEO* softkey activates triggering through the displayed voltage.

For the video triggering mode, a horizontal trigger line is shown in the diagram. It may be used to set the trigger threshold between 0% and 100% of the overall diagram height.

IEC/IEEE-bus command: `TRIG:SOUR VID`
`TRIG:LEV:VID 50 PCT`

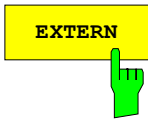

The *EXTERN* softkey activates triggering via a TTL signal at the input connector *EXT TRIGGER/GATE* on the rear panel.

IEC/IEEE-bus command: TRIG:SOUR EXT
 SWE:EGAT:SOUR EXT

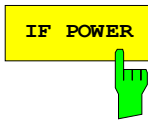

The *IF POWER* softkey activates triggering of the measurement via signals which are outside the measurement channel.

For this purpose, the FSP uses a level detector at the second intermediate frequency. can be selected in a range between -30 dBm and -10 dBm at the input mixer. The resulting trigger level at the RF input is calculated via the following formula:

$$Mixerlevel_{min} + RFAtt - PreampGain \leq Input\ Signal \leq Mixerlevel_{max} + RFAtt - PreampGain$$

The bandwidth at the intermediate frequency is 10 MHz. The FSP is triggered as soon as the trigger threshold is exceeded within a 5 MHz range around the selected frequency (= start frequency in the frequency sweep).

Thus, the measurement of spurious emissions, e.g. for pulsed carriers, is possible even when the carrier lies outside the selected frequency span.

IEC/IEEE-bus command: TRIG:SOUR IFP
 SWE:EGAT:SOUR IFP

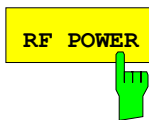

See following section
 Option FSP-B6 – TV and RF Trigger, page 4.9-8.

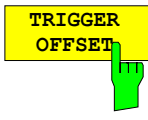

The *TRIGGER OFFSET* softkey activates the window for entering the time offset between the trigger signal and the start of the sweep.

Triggering is delayed by the entered time with respect to the trigger signal (time entered > 0) or is started earlier (time entered < 0). The time may be entered in multiples of 125 ns in the range -100 s to 100 s (default 0 s).

Note: A negative offset (pretrigger) can be set in the time domain only (SPAN = 0 Hz) provided GATED TRIGGER is not active in that domain.
 The maximum allowed range and the maximum resolution of the pretrigger is limited by the set sweep time:
 max. range = - 499/500 x sweep time
 max. resolution = sweep time/500.
 Pretriggering is not possible when the rms or the average detector is activated

As a common input signal is used for both trigger and gate when selecting *EXTERN* and *IF POWER*, changes to the gate delay will affect the trigger delay (*TRIGGER OFFSET*) as well.

IEC/IEEE-bus command: TRIG:HOLD 10US

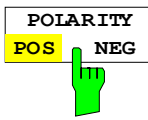

The *POLARITY POS/NEG* softkey selects the polarity of the trigger source.

The sweep starts after a positive or negative edge of the trigger signal. The selected setting is highlighted.

The selection is valid for all trigger modes with the exception of *FREE RUN*; in the gate mode, it also applies to the gate polarity.

The default setting is *POLARITY POS*.

IEC/IEEE-bus command: TRIG:SLOP POS

By using a gate in sweep mode and stopping the measurement while the gate signal is inactive, the spectrum for pulsed RF carriers can be displayed without the superposition of frequency components generated during switching. Similarly, the spectrum can also be examined for an inactive carrier. The sweep can be controlled by an external gate or by the internal power trigger.

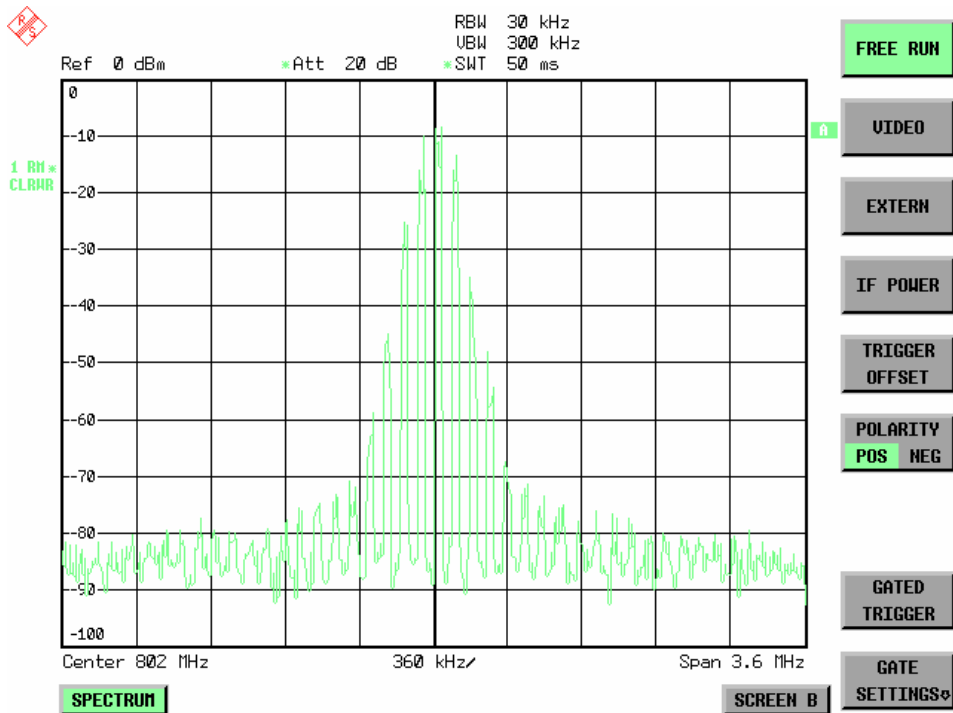

Fig. 4.9-1 Pulsed signal GATE OFF

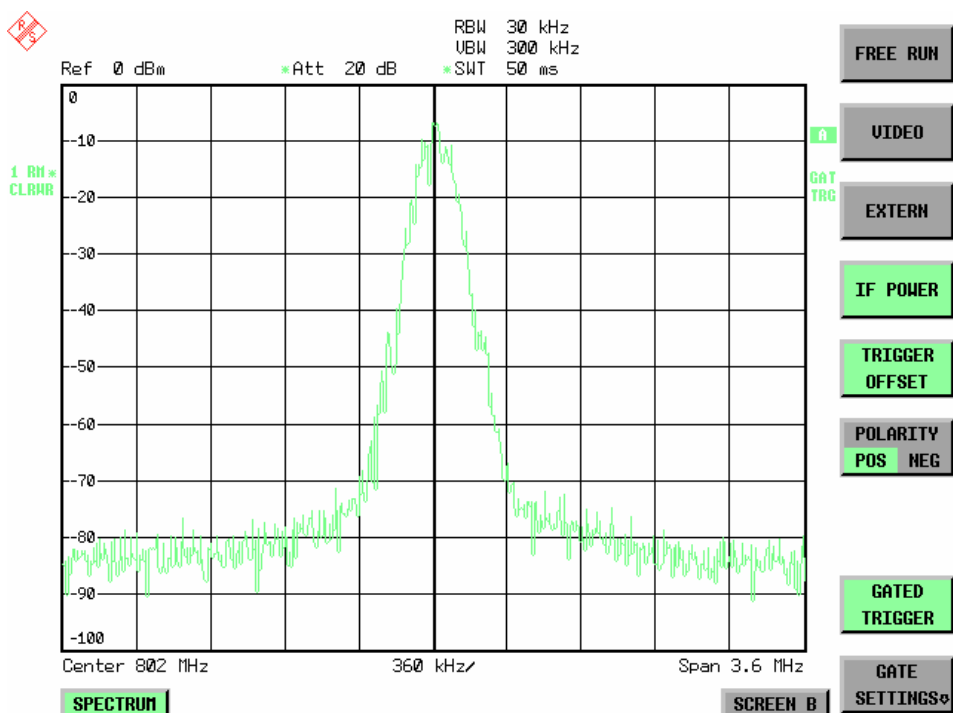
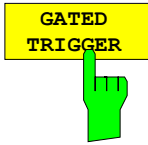

Fig. 4.9-2 TDMA signal with GATE ON

The gated-sweep mode is activated by the *GATED TRIGGER* softkey. The setting of the mode takes place in the *GATE SETTINGS* submenu.



The *GATED TRIGGER* softkey switches the sweep mode with gate on and off.

When gate is switched on, a gate signal applied to the rear panel connector *EXT TRIGGER/GATE* or the internal IF power detector controls the sweep of the analyzer. This selection is made via the *EXTERN* and *IF POWER* softkeys for trigger and gate.

The length of the gate signal defines when the sweep is to be interrupted. Here a differentiation is made between edge-triggered and level-triggered modes: in case of edge triggering the gate length can be set via the *GATE LENGTH* softkey, while in case of level triggering the gate length depends on the length of the gate signal.

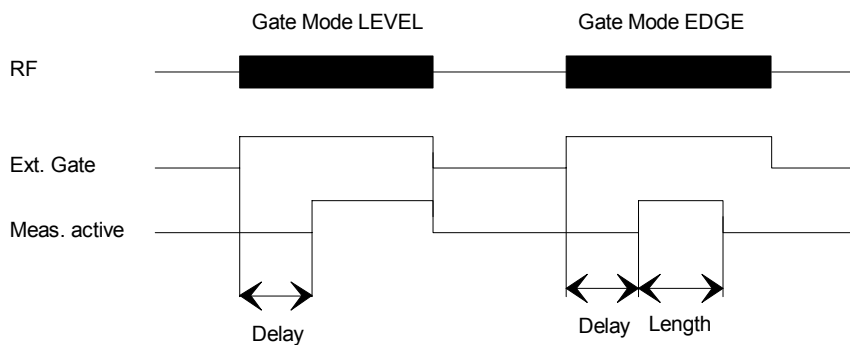

Fig.4.9-3 Timing diagram for GATE, GATE DELAY and GATE LENGTH

This softkey requires the *EXTERN* or *IF POWER* trigger mode. If a different mode is active, *IF POWER* is automatically selected.

Gated-sweep operation is also possible in the time domain. This enables - e.g. in burst signals - level variations of individual slots to be displayed versus time.

To indicate that a gate is used for the sweep, the enhancement label **GAT** is displayed on the screen. This label appears to the right of the window for which the gate is configured.

```
IEC/IEEE-bus command:  SWE:EGAT  ON
                        SWE:EGAT:SOUR  IFP
                        OR:
                        SWE:EGAT:SOUR  EXT
```

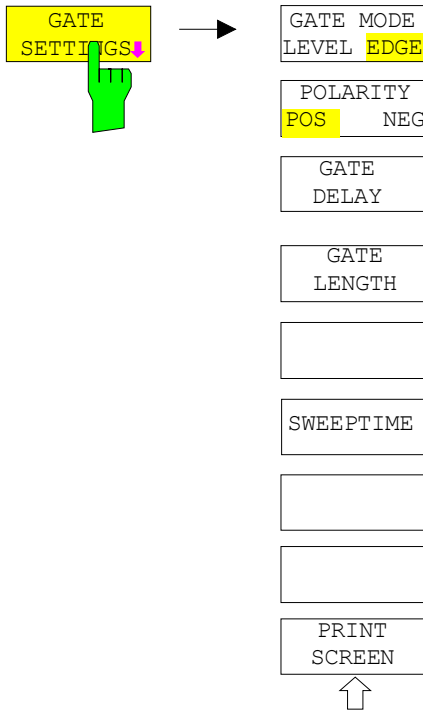

The *GATE SETTINGS* softkey calls a submenu for making all the settings required for gated-sweep operation.

At the same time, a transition is made to the time domain (span = 0) and the time parameters *GATE DELAY* and *GATE LENGTH* are represented as vertical lines. This allows the required gate time parameters to be set easily.

For highly accurate setting of gate delay and gate length, the x axis can be altered using the *SWEPTIME* softkey in a way that the signal range concerned (e.g. one full burst) is displayed.

Then the sampling time and duration can be set by *GATE DELAY* and *GATE LENGTH* in a way that the desired portion of the signal is shown.

When quitting the submenu, the program will return to the frequency domain provided it was active before. The original span is restored so the desired measurement can now be performed with the accurately set gate.

IEC/IEEE-bus command: --

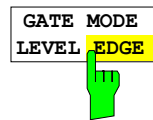

The *GATE MODE LEVEL/EDGE* softkey selects the trigger mode. Gated sweep is possible in the level-triggered as well as in the edge-triggered mode.

If level triggering is selected, the *GATE LENGTH* softkey becomes inactive and cannot be operated.

IEC/IEEE-bus command: SWE:EGAT:TYPE EDGE



The *POLARITY POS/NEG* softkey controls the polarity of the *EXT TRIGGER/GATE* control line.

In case of level triggering the sweep is stopped by *POLARITY POS* and a logic '0' signal; the signal '1' will restart the sweep after the *GATE DELAY* time has elapsed.

In case of edge triggering the sweep is continued on a '0' to '1' transition for the duration of *GATE LENGTH* after a delay (*GATE DELAY*) has elapsed.

Changing the polarity automatically implies a transition of the trigger-edge polarity (*POLARITY* softkey in the higher menu).

IEC/IEEE-bus command: SWE:EGAT:POL POS

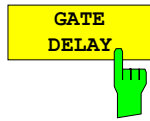

The *GATE DELAY* softkey activates the window for setting the delay time between the gate signal and the continuation of the sweep.

This may be useful for taking into account a delay between the gate signal and the stabilization of an RF carrier for example.

As gate delay, values between 125 ns and 100 s may be set. The position of the delay on the time axis in relation to the sweep is indicated by the line labelled **GD**.

As there is a common input signal for trigger and gate if *EXTERN* or *IF POWER* is selected, changes to the gate delay will affect the trigger delay (*TRIGGER OFFSET*) as well.

IEC/IEEE-bus command: `SWE:EGAT:HOLD 1US`

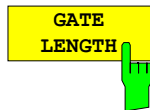

The *GATE LENGTH* softkey activates the window for setting the sweep duration of FSP in the edge-triggered mode.

Values between 125 ns and 100 s may be set for the gate length. The length of the gate in relation to the sweep is indicated by the line labelled **GL**.

This softkey is only available if *GATE MODE EDGE* (edge triggering) has been selected.

IEC/IEEE-bus command: `SWE:EGAT:LENG 100US`

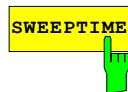

The *SWEEP TIME* softkey enables the user to change the time axis to obtain a higher resolution for positioning gate delay and gate length.

When this is to be done, the sweep time temporarily changes; the original value is restored when the menu is quit.

IEC/IEEE-bus command: `--`

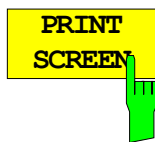

The *PRINT SCREEN* softkey allows the gate settings to be output on a printer.

IEC/IEEE-bus command: `--`

Measurement example:

The modulation spectrum of a GSM or PCS1900 signal is to be measured using the gated-sweep function. The signal is generated by a Signal Generator SME03 whose RF output is directly connected to the RF input of FSP.

The modulation spectrum of a GSM 900 signal is to be measured using the gated-sweep function. The signal is generated by a Signal Generator SME03 whose RF output is directly connected to the RF input of FSP.

Settings on SME03:

FREQ:	802 MHz
Level:	0 dBm: Return
Digital Mod:	Select: GMSK: Select
Source:	Select: PRBS: Select: Return
Level Attenuation:	Select: 60 dB: Return

The SME03 supplies a GMSK-modulated TDMA signal (GSM).

Settings on FSP:

Conventions: **[KEY]** Menu called by this key. All information between the brackets refers to this menu.
 {Number} Numeric value to be entered for the parameter on hand.
 SOFTKEY Softkey to be used for making a selection or entering a value.

[PRESET]
[FREQ: *CENTER {802} MHz]*
[SPAN *{3.6} MHz]*
[AMPT: *REF LEVEL {0} dBm: RF ATTEN MANUAL: {10} dB]*
[BW: *RES BW MANUAL: {30} kHz]*
[TRACE : *TRACE 1 DETECTOR: RMS]*
[SWEEP: *SWEEPTIME MANUAL: {50} ms]*
[TRIG: *EXTERN*
 GATED TRIGGER;
 GATE SETTINGS: GATE MODE EDGE; POLARITY POS
 SWEEPTIME MANUAL {1} ms: GATE DELAY {300} μs;
 GATE LENGTH: {250} μs]

The following figure shows the screen display for setting gate parameters. The vertical lines for gate delay (GD) and gate length (GL) can be adjusted to the burst signal by entering numeric values or by means of the rollkey.

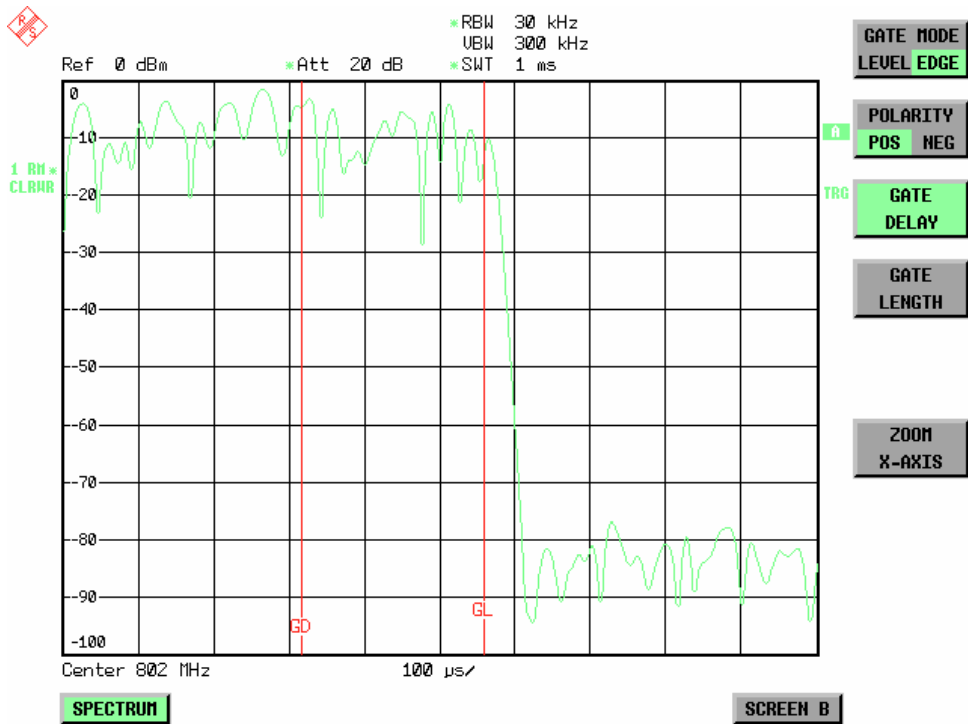

Fig.4.9-4 Setting GATE DELAY and GATE LENGTH in time domain by means of lines GD and GL

On quitting the *GATE SETTINGS* menu, FSP returns to the previous screen.

Menu TRIG - NEXT



The *DELAY COMP ON/OFF* softkey enables the filter group delay compensation for the external trigger. If a bursted signal is analyzed in zero span and the delay compensation is on, a change of the RBW will not change the rising slope of the signal.
Default is *OFF*.

Note:

The GSM/EDGE application FS-K5 and the 1xEV-DO BTS application FS-K84 are implicitly using delay compensation active since their first version.

IEC/IEEE-bus command: TRIG:HOLD:ADJ:AUTO ON|OFF

Option FSP-B6 – TV and RF Trigger

The option TV and RF Trigger, FSP-B6, enables the FSP to trigger on TV signals or on the presence of a RF carrier outside the resolution bandwidth.

For this purpose, the hardware board is equipped with a TV demodulator, which produces the trigger signals necessary for the analysis of TV signals. In addition to the pure trigger function, the board also creates a demodulated CCVS video signal for operation of external TV monitors. Apart from using the internal IF for creating the trigger signals, the FSP can also make use of an externally supplied CCVS signal; the corresponding connector is placed at the rear panel of the instrument.

In order to display different sections of a TV video signal, the FSP derives several trigger signals from the video signals. This allows triggering as well on the frame repetition as on each line of the TV video signal.

Additionally, the option includes a broadband RF detector (bandwidth = 80 MHz), which allows triggering within a 40 MHz range around the selected frequency (= start frequency in the frequency sweep). Thus, the measurement of spurious emissions, e.g. for pulsed carriers, is possible even when the carrier lies outside the selected frequency span. This RF power trigger can be used as long as the RF signal at the input mixer is in the range of -10 dBm to -50 dBm. The resulting range for the input signal at the RF input connector can be calculated using the following formula:

$$Mixerlevel_{min} + RFA_{Att} - Pr eampGain \leq Input\ Signal \leq Mixerlevel_{max} + RFA_{Att} - Pr eampGain$$

The RF Power Trigger can be selected and configured in the trigger menu (TRIG) using the softkey RF POWER:

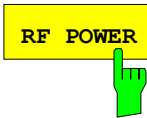

The *RF POWER* softkey activates triggering of the measurement via signals which are outside the measurement channel.

For this purpose the instrument uses a level detector at the first intermediate frequency. The detector threshold can be selected in a range between -50 dBm and -10 dBm at the input mixer. The resulting trigger level at the RF input is calculated via the following formula:

$$\text{Mixerlevel}_{\min} + \text{RFAtt} - \text{Pr eampGain} \leq \text{Input Signal} \leq \text{Mixerlevel}_{\max} + \text{RFAtt} - \text{Pr eampGain}$$

The bandwidth at the intermediate frequency is 80 MHz. The instrument is triggered as soon as the trigger threshold is exceeded within a 40 MHz range around the selected frequency (= start frequency in the frequency sweep). Thus, the measurement of spurious emissions, e.g. for pulsed carriers, is possible even when the carrier lies outside the selected frequency span.

The FSP uses a level detector at the first IF. The detector's threshold can be selected from values between -50 dBm and -10 dBm at the input mixer. The range of the input signal to which the trigger responds is calculated using the following formula.

$$\text{Mixerlevel}_{\min} + \text{RFAtt} - \text{Pr eampGain} \leq \text{Input Signal} \leq \text{Mixerlevel}_{\max} + \text{RFAtt} - \text{Pr eampGain}$$

The bandwidth at the IF is 80 MHz. Triggering starts when the trigger threshold is exceeded in a range of 40 MHz around the frequency selected (= start frequency for frequency sweep). This allows spurious emissions, e.g. with pulsed carriers, to be measured, even if the carrier itself is outside the frequency display range.

IEC/IEEE-bus command: `TRIG:SOUR RFP`
`SWE:EGAT:SOUR RFP`

The configuration menu for TV trigger settings can be reached with key sequence *TRIG – NEXT – TV TRIG SETTINGS*:

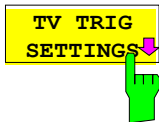

The *TV TRIG SETTINGS* softkey switches the TV trigger on and opens a submenu for configuration of the TV signal parameters.

Note: Triggering on TV signals is only possible in time domain (span = 0 Hz). Therefore the softkey *TV TRIG SETTINGS* is without function in frequency domain.

IEC/IEEE-bus command: `TRIG:SOUR TV`

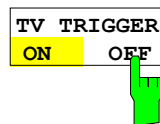

The *TV TRIGGER ON/OFF* softkey switches the TV Trigger on or off. When switching off the TV trigger the selected trigger source will be *FREE RUN*.

IEC/IEEE-bus command: `SENS:TV ON | OFF`

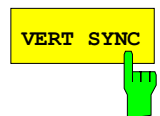

The *VERT SYNC* softkey configures the trigger for the vertical sync signal. The FSP triggers on the frame repetition without distinction between the two fields.

IEC/IEEE-bus command: `TRIG:VID:FIEL:SEL ALL`



The softkeys *VERT SYNC ODD FIELD* and *VERT SYNC EVEN FIELD* configure the trigger for the vertical sync signal of the first or second field.



IEC/IEEE-bus command:

```
TRIG:VID:FIEL:SEL EVEN | ODD
```



The *HOR SYNC* softkey configures the trigger for the horizontal sync signal and opens the data entry field for selection of the corresponding line.

The trigger can be set on any line number, which can be in the range of 1 to 525 or 1 to 625, depending on the line system. The maximum possible line number will be selected if the active range is exceeded.

In order to trigger on test line 17 according to CCIR 473-4, for example, the line value has to be set to 17. This is the default setting after switching on the TV trigger.

IEC/IEEE-bus command: `TRIG:VID:LINE:NUM 17`



The *VIDEO POL POS / NEG* softkey selects the polarity of the video signal.

Positive video polarity is to be selected e.g. for standard L signals, negative video polarity for signals according to the standards B/G/I/M (colour standard PAL or NTSC). Default setting is *VIDEO POL NEG*.

IEC/IEEE-bus command: `TRIG:VID:SSIG:POL NEG`

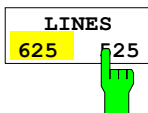

The *LINES 625 / 525* softkey selects the line system currently in use.

Default setting is *625 LINES*.

IEC/IEEE-bus command: `TRIG:VID:FORM:LPFR 625`

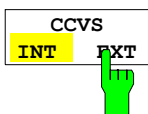

The *CCVS INT / EXT* softkey selects the input channel for the TV trigger input signal. An external CCVS signal can be supplied via the corresponding connector at the rear panel of the instrument.

IEC/IEEE-bus command: `SENS:TV:CCVS INT`

Selection and Setting of Traces – TRACE Key

The traces are selected using the *SELECT TRACE* softkey in the menu of the *TRACE* key.

The traces can individually be activated for a measurement or frozen after completion of a measurement. Traces that are not activated are blanked.

The display mode can be selected for each trace. Traces can be overwritten in each measurement (CLEAR/WRITE mode), averaged over several measurements (AVERAGE mode), or a maximum or minimum value can be determined from several measurements and displayed (MAX HOLD or MIN HOLD). Individual detectors can be selected for the various traces. The autopeak detector displays maximum and minimum values connected by a vertical line. The max peak detector and min peak detector display the maximum and minimum value of the level within a pixel. The sample detector displays the instantaneous value of the level at a pixel. The rms detector displays the power (rms value) of the measured values within a pixel, the average detector the average value.

Selection of Trace Function

The trace functions are subdivided as follows:

- Display mode of trace (CLEAR/WRITE, VIEW and BLANK)
- Evaluation of the trace as a whole (AVERAGE, MAX HOLD and MIN HOLD)
- Evaluation of individual pixels of a trace (AUTOPEAK, MAX PEAK, MIN PEAK, SAMPLE, RMS, AVERAGE and QUASIPEAK)

TRACE menu

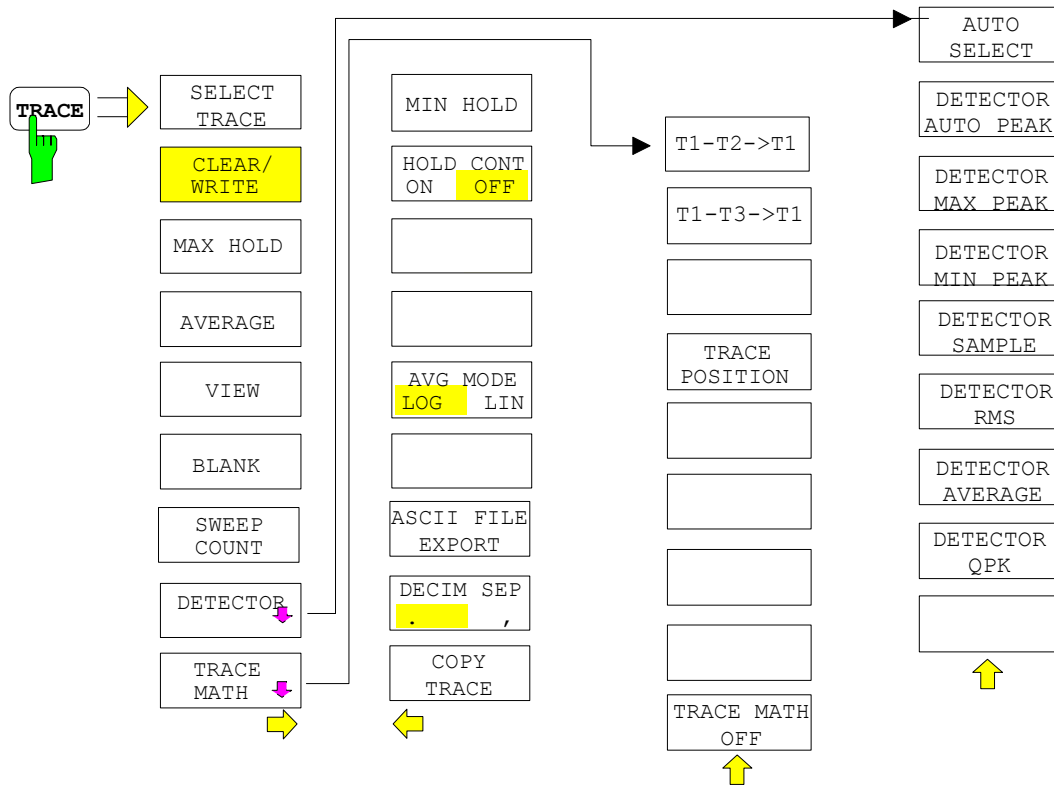

The *TRACE* key opens a menu offering the setting options for the selected trace.

Traces can be displayed, blanked and copied. Traces can also be corrected with the aid of mathematical functions.

The measurement detector for the individual display modes can be selected directly by the user or set automatically by FSP.

The default setting is trace 1 in the overwrite mode (*CLEAR / WRITE*), the other traces 2 and 3 are switched off (*BLANK*).

The *CLEAR/WRITE*, *MAX HOLD*, *MIN HOLD*, *AVERAGE*, *VIEW* and *BLANK* softkeys are mutually exclusive selection keys.



The *SELECT TRACE* softkey activates the entry for the active trace (1, 2, 3).

IEC/IEEE-bus command -- (selected via numeric suffix of :TRACe)

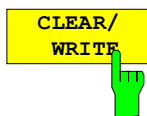

The *CLEAR/WRITE* softkey activates the overwrite mode for the collected measured values, ie the trace is overwritten by each sweep.

In the *CLEAR/WRITE* display mode all the available detectors can be selected. In the default mode the autopeak detector (setting *AUTO*) is selected.

Each time the *CLEAR/WRITE* softkey is actuated, FSP clears the selected trace memory and starts the measurement anew.

IEC/IEEE-bus command `DISP:WIND:TRAC:MODE WRIT`

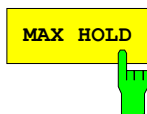

The *MAX HOLD* softkey activates the max peak detector.

FSP saves the sweep result in the trace memory only if the new value is greater than the previous one.

The detector is automatically set to *MAX PEAK*. The maximum value of a signal can thus be determined over several sweeps.

This is especially useful with modulated or impulsive signals. The signal spectrum is filled up upon each sweep until all signal components are detected in a kind of envelope.

Pressing the *MAX HOLD* softkey again clears the trace memory and restarts the max hold mode.

IEC/IEEE-bus command `DISP:WIND:TRAC:MODE MAXH`

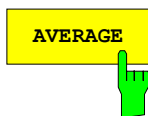

The *AVERAGE* softkey activates the trace averaging function. The average is formed over several sweeps. Averaging can be performed with any of the detectors available. If the detector is automatically selected by FSP, the sample detector is used.

Depending on the setting of AVG MODE LOG / LIN, the logarithmic level values or the measured power/voltage values are averaged.

Averaging is restarted every time the *AVERAGE* softkey is pressed. The trace memory is always cleared.

IEC/IEEE-bus command `DISP:WIND:TRAC:MODE AVER`

Description of averaging

Averaging is carried out over the pixels derived from the measurement samples. Several measured values may be combined in a pixel. This means that with linear level display the average is formed over linear amplitude values and with logarithmic level display over levels. For this reason the trace must be measured again when changing between *LIN* and *LOG* display mode. The settings *CONT/SINGLE SWEEP* and running averaging apply to the average display analogously.

There are two methods for calculating the average. For a sweep count = 0, a running average is calculated according to the following formula:

$$\text{TRACE} = \frac{9 * \text{TRACE} + \text{meas. value}}{10}$$

Due to the weighting between the new measured value and the trace average, past values have practically no influence on the displayed trace after about ten sweeps. With this setting, signal noise is effectively reduced without need for restarting the averaging process after a change of the signal.

If the sweep count is >1, averaging takes place over the selected number of sweeps. In this case the displayed trace is determined during averaging according to the following formula:

$$\text{Trace}_n = \frac{1}{n} \left[\sum_{i=1}^{n-1} (T_i) + \text{meas. value}_n \right]$$

where *n* is the number of the current sweep (*n* = 2 ... *SWEEP COUNT*). No averaging is carried out for the first sweep but the measured value is stored in the trace memory. With increasing *n*, the displayed trace is increasingly smoothed since there are more single sweeps for averaging.

After the selected number of sweeps the average trace is saved in the trace memory. Until this number of sweeps is reached, a preliminary average is displayed.

After completion of averaging, ie when the averaging length defined by *SWEEP COUNT* is attained, a running averaging is continued with *CONTINUOUS SWEEP* according to the following formula:

$$\text{Trace} = \frac{(N-1) \cdot \text{Trace}_{\text{old}} + \text{meas. value}}{N} \quad \text{where} \quad \begin{array}{l} \text{Trace} = \text{new trace} \\ \text{Trace}_{\text{old}} = \text{old trace} \\ N = \text{SWEEP COUNT} \end{array}$$

The display "Sweep N of N" does not change any more until a new start is triggered.

In the *SINGLE SWEEP* mode, the number of sweeps is triggered with *SWEEP START*. The sweeps are stopped when the selected number of sweeps is attained. The number of the current sweep and the total number of sweeps are shown on the display: "Sweep 3 of 200".

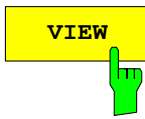

The *VIEW* softkey freezes the current contents of the trace memory and displays it.

If a trace is frozen by *VIEW*, the instrument settings can be changed without the displayed trace being modified (exception: level display range and reference level, see below). The fact that the trace and the current instrument setting do not agree any more is indicated by an enhancement label "*" at the right edge of the grid.

If in the *VIEW* display mode the level display range (*RANGE*) or the reference level (*REF LEVEL*) are changed, FSP automatically adapts the measured data to the changed display range. This allows an amplitude zoom to be made after the measurement in order to show details of the trace.

IEC/IEEE-bus command `DISP:WIND:TRAC:MODE VIEW`

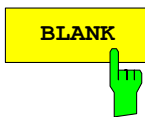

The *BLANK* softkey activates the blanking of the trace on the screen.

IEC/IEEE-bus command `DISP:WIND:TRAC OFF`

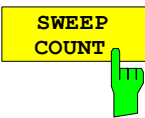

The *SWEEP COUNT* softkey activates the entry of the number of sweeps used for averaging. The allowed range of values is 0 to 30000 and the following should be observed:

- Sweep Count = 0 means running averaging
- Sweep Count = 1 means no averaging being carried out
- Sweep Count > 1 means averaging over the selected number of sweeps; in the continuous sweep mode averaging is performed until the set number of sweeps is attained and is then continued as running averaging.

The default setting is running averaging (Sweep Count = 0). The number of sweeps used for averaging is the same for all active traces in the selected diagram.

Note: *The setting of the sweep count in the trace menu is equivalent to the setting in the sweep menu.*

IEC/IEEE-bus command `SWE:COUN 64`



See following Section "Selection of Detector"

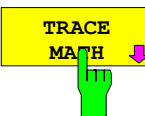

See following Section "Mathematical Functions for Traces"

TRACE - NEXT menu

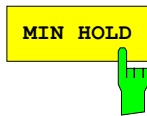

The *MIN HOLD* softkey activates the min peak detector. FSP saves for each sweep the smallest of the previously stored/currently measured values in the trace memory. The detector is automatically set to *MIN PEAK*. In this way, the minimum value of a signal can be determined over several sweeps.

This function is useful eg for making an unmodulated carrier in a composite signal visible. Noise, interference signals or modulated signals are suppressed by the min hold function whereas a CW signal is recognized by its constant level.

Pressing the *MIN HOLD* softkey again clears the trace memory and restarts the min hold function.

IEC/IEEE-bus command

DISP:WIND:TRAC:MODE MINH

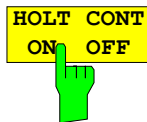

The *HOLD CONT* softkey defines whether the traces in min hold and max hold mode are reset after some specific parameter changes.

OFF The traces are reset after some definite parameter changes (default)

ON This mechanism is switched off.

In general, parameter changes require a restart of the measurement before results are evaluated (e. g. with markers). For those changes that are known to require a new measurement (e. g. modification of the span), the trace is automatically reset.

This mechanism can be switched off for those exceptional cases where the described behavior is unwelcome.

IEC/IEEE-bus command

:DISPlay[:WINDow<1|2>]:TRACe<1..4>:MODE:HCON ON|OFF



The *AVG MODE LOG/LIN* softkey selects logarithmic or linear averaging for the logarithmic level display mode.

At the same time the difference calculation is switched between linear and logarithmic in submenu *TRACE MATH*.

IEC/IEEE-bus command

CALC:MATH:AVER:MODE LIN

With logarithmic averaging, the dB values of the display voltage are averaged or subtracted from each other with trace mathematical functions. With linear averaging the level values in dB are converted into linear voltages or powers prior to averaging. Voltage or power values are averaged or offset against each other and reconverted into level values.

For stationary signals the two methods yield the same result.

Logarithmic averaging bzw. Verrechnung is recommended if sinewave signals are to be clearly visible against noise since with this type of averaging noise suppression is improved while the sinewave signals remain unchanged.

For noise or pseudo-noise signals the positive peak amplitudes are decreased in logarithmic averaging due the characteristic involved and the negative peak values are increased relative to the average value. If the distorted amplitude distribution is averaged, a value is obtained that is smaller than the actual average value. The difference is -2.5 dB.

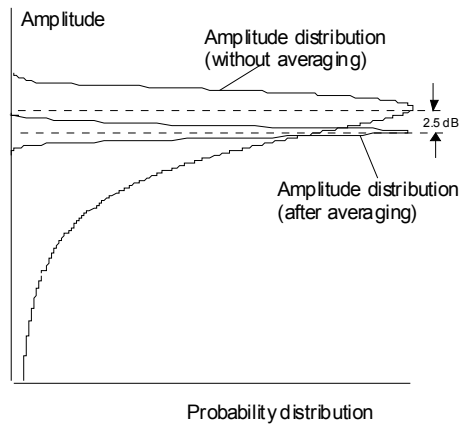

This low average value is usually corrected in noise power measurements by a 2.5 dB factor. Therefore the FSP offers the selection of linear averaging. The trace data are delogarithmized prior to averaging, then averaged and logarithmized again for display on the screen. The average value is always correctly displayed irrespective of the signal characteristic.

ASCII FILE
EXPORT



The *ASCII FILE EXPORT* softkey stores the active trace in ASCII format on a floppy disk.

IEC/IEEE command `FORM ASC;`
 `MMEM:STOR:TRAC 1, 'TRACE.DAT'`

The file consists of the header containing important scaling parameters and a data section containing the trace data.

The data of the file header consist of three columns, each separated by a semicolon:

parameter name; numeric value; basic unit

The data section starts with the keyword " Trace <n> " (<n> = number of stored trace), followed by the measured data in one or several columns (depending on measurement) which are also separated by a semicolon.

This format can be read in from spreadsheet calculation programs, eg MS-Excel. It is necessary to define ';' as a separator.

Note: *Different language versions of evaluation programs may require a different handling of the decimal point. It is therefore possible to select between separators '.' (decimal point) and ',' (comma) using softkey DECIM SEP.*

Example:		
File contents	Description	
File header	<p>Type;FSP3; Version;1.00; Date;01.Jul 1999; Mode;Spectrum; Center Freq;55000;Hz Freq Offset;0;Hz Span;90000;Hz x-Axis;LIN; Start;10000;Hz Stop;100000;Hz Ref.Level;-30;dBm Level Offset;0;dB Ref Position;75;% y-Axis;LOG; Level Range;100;dB RF Att;20;dB RBW;100000;Hz VBW;30000;Hz SWT;0.005;s Trace Mode;AVERAGE; Detector;SAMPLE; Sweep Count;20;</p>	<p>Instrument model Firmware version Date of data set storage Instrument mode Center frequency Frequency offset Frequency range (0 Hz with zero span and statistics measurements) Scaling of x axis linear (LIN) or logarithmic (LOG) Start/stop of the display range. Unit: Hz for span > 0, s for span = 0, dBm/dB for statistics measurements Reference level Level offset Position of reference level referred to diagram limits (0% = lower edge) Scaling of y axis linear (LIN) or logarithmic (LOG) Display range in in y direction. Unit: dB with x axis LOG, % with x axis LIN Input attenuation Resolution bandwidth Video bandwidth Sweep time Display mode of trace: CLR/WRITE,AVERAGE,MAXHOLD,MINHOLD Detector set: AUTOPEAK,MAXPEAK,MINPEAK,AVERAGE, RMS,SAMPLE,QUASPEAK Number of sweeps set</p>
Data section of the file	<p>Trace 1;; x-Unit;Hz; y-Unit;dBm; Values; 501; 10000;-10.3;-15.7 10180;-11.5;-16.9 10360;-12.0;-17.4 ...;...;</p>	<p>Selected trace Unit of x values: Hz with span > 0; s with span = 0; dBm/dB with statistics measurements Unit of y values: dB*/V/A/W depending on the selected unit with y axis LOG or % with y axis LIN Number of test points Measured values: <x value>, <y1>, <y2> <y2> being available only with detector AUTOPEAK and containing in this case the smallest of the two measured values for a test point.</p>

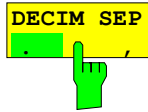

The *DECIM SEP* softkey selects the decimal separator between '.' (decimal point) and ',' (comma) with floating-point numerals for the function ASCII FILE EXPORT.

With the selection of the decimal separator different language versions of evaluation programs (eg MS-Excel) can be supported.

IEC/IEEE-bus command `FORM:DEXP:DSEP POIN`



The *COPY TRACE* softkey copies the screen contents of the current trace into another trace memory. The desired memory is selected by entering the number 1, 2 or 3.

Upon copying, the contents of the selected memory is overwritten and the new contents displayed in view mode.

IEC/IEEE-bus command `TRAC:COPY TRACE1,TRACE2`

Selection of Detector

The detectors of the FSP are implemented as pure digital devices. The detectors available are the peak detectors which determine the maximum and/or the minimum value from a number of samples, the rms detector which measures the power within a pixel, the average, the quasipeak and the sample detector. The sample detector routes through the sampled data without any modification or performs a data reduction by suppressing measured values that cannot be displayed.

The peak detectors compare the current level value with the maximum or minimum level from the previously sampled data. When the number of samples defined by the instrument setting is reached, the samples are combined in displayable pixels. Each of the 501 pixels of the display thus represents 1/501 of the sweep range and contains all single measurements (frequency samples) in this subrange in compressed form. For each trace display mode an optimized detector is selected automatically. Since peak detectors and sample detector are connected in parallel, a single sweep is sufficient for collecting all detector values for 3 traces.

Peak detectors
(*MAX PEAK* and *MIN PEAK*)

Peak detectors are implemented by digital comparators. They determine the largest of all positive (max peak) or the smallest of all negative (min peak) peak values of the levels measured at the individual frequencies which are displayed in one of the 501 pixels. This procedure is repeated for each pixel so that for wide frequency spans and despite the limited resolution of the display a large number of measurements can be taken into consideration for the display of the spectrum.

Autopeak detector

The *AUTOPEAK* detector combines the two peak detectors. The max peak detector and the min peak detector simultaneously determine the maximum and the minimum level within a displayed testpoint and display it as a single measured value. The maximum and minimum levels within a frequency point are connected by a vertical line.

Sample detector

The *SAMPLE* detector routes through the sampled data without any further evaluation and either displays them directly or, for reasons of speed in case of short sweep times, first writes them into a memory and processes them subsequently.

There is no data reduction, ie no summing up of measured values of neighbouring frequencies or time samples. If during a frequency sweep more measured values are obtained than can be displayed, measured values will be lost. This means that discrete signals might be lost.

The sample detector therefore can only be recommended for a span-to-resolution bandwidth ratio of up to approx. 250 in order to ensure that no signal will be suppressed (example: span 1 MHz, - > min. bandwidth 5 kHz).

RMS detector	<p>The RMS detector forms the rms value of the measured values within a pixel.</p> <p>To this effect, FSP uses the linear voltage after envelope detection. The sampled linear values are squared, summed and the sum is divided by the number of samples (= root mean square). For logarithmic display the logarithm is formed from the square sum. For linear display the root mean square value is displayed. Each pixel thus corresponds to the power of the measured values summed up in the pixel.</p> <p>The rms detector supplies the power of the signal irrespective of the waveform (CW carrier, modulated carrier, white noise or impulsive signal). Correction factors as needed for other detectors for measuring the power of the different signal classes are not required.</p>
Average detector	<p>The average detector forms the average value of the measured values within a pixel.</p> <p>To this effect, FSP uses the linear voltage after envelope detection. The sampled linear values are summed up and the sum is divided by the number of samples (= linear average value). For logarithmic display the logarithm is formed from the average value. For linear display the average value is displayed. Each pixel thus corresponds to the average of the measured values summed up in the pixel.</p> <p>The average detector supplies the average value of the signal irrespective of the waveform (CW carrier, modulated carrier, white noise or impulsive signal).</p>
Quasipeak detector	<p>The quasipeak detector simulates the behaviour of an analog voltmeter by evaluating the measured values in a pixel.</p> <p>The quasipeak detector is especially designed for the requirements of EMC measurements and is used for evaluating pulse-shaped spurious.</p>

Note: *During a frequency sweep, FSP increments the 1st local oscillator in steps that are smaller than approximately 1/10 of the bandwidth. This is to ensure that the signal level is correctly measured. For narrow bandwidths and wide frequency spans a very large number of measured values is thus obtained. The number of frequency steps, however, always is a multiple of 501 (= number of pixels that can be displayed). With the sample detector selected, only every n^{th} value is displayed. The value of n depends on the number of measured values, ie on the frequency span, the resolution bandwidth and the measurement rate.*

TRACE-DETECTOR submenu

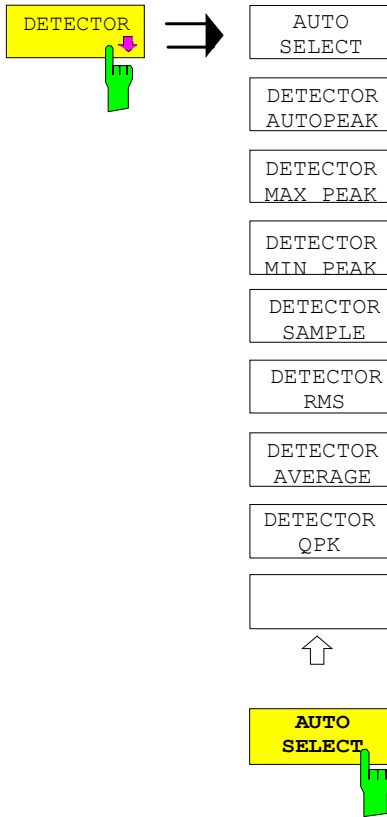

The *DETECTOR* softkey opens a submenu for selecting the detector for the selected trace. The softkey is highlighted if the detector is not selected with *AUTO SELECT*.

The detector can be selected independently for each trace. The *AUTO SELECT* mode selects the optimum detector for each display mode of the trace (Clear/Write, Max Hold or Min Hold).

The softkeys for the detectors are mutually exclusive selection keys.

The *AUTO SELECT* softkey (= default setting) selects the optimum detector for the set display mode of the trace (Clear/Write, Max Hold and Min Hold) and the selected filter mode (bandpass/FFT).

Trace display	Detector (bandpass)	Detector (FFT)
Clear/Write	Auto Peak	Max Peak
Average	Sample	Sample
Max Hold	Max Peak	Max Peak
Min Hold	Min Peak	Max Peak

The detector activated for the specific trace is identified in the respective trace display field as follows:

Detector	
Auto Peak	AP
Max Peak	PK
Min Peak	MI
Average	AV
RMS	RM
Sample	SA
Quasipeak	QP

IEC/IEEE-bus command DET:AUTO ON

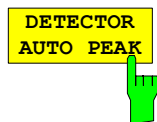

The *DETECTOR AUTOPEAK* softkey activates the autopeak detector.

IEC/IEEE-bus command DET APE

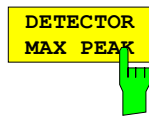

The *DETECTOR MAX PEAK* softkey activates the max peak detector. It is recommended for measurement of impulsive signals.

IEC/IEEE-bus command DET POS

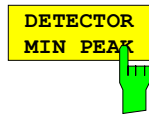

The *DETECTOR MIN PEAK* softkey activates the min peak detector. Weak sinewave signals become clearly visible in noise using this detector. In case of a composite signal made up of sinewave and impulsive signals, the impulsive signals are suppressed.

IEC/IEEE-bus command DET NEG

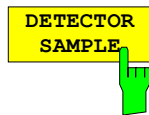

The *DETECTOR SAMPLE* softkey activates the sample detector.

It is used for measuring uncorrelated signals such as noise. The power can be determined with the aid of fixed correction factors for evaluation and the logarithmic function.

IEC/IEEE-bus command DET SAMP

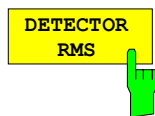

The *DETECTOR RMS* softkey activates the rms detector.

The rms detector supplies the power of the signal independent of the waveform. For this effect the root mean square of all sampled level values is formed during the sweep of a pixel. The sweep time thus determines the number of averaged values and with increasing sweep time better averaging is obtained. The rms detector is thus an alternative for averaging over several sweeps (see TRACE AVERAGE).

Since the video bandwidth must be at least 10 times the resolution bandwidth (RBW) to ensure that video filtering does not invalidate the rms values of the signal, this ratio is set automatically upon activating the detector.

IEC/IEEE-bus command DET RMS

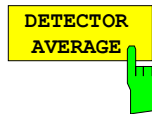

The *DETECTOR AVERAGE* softkey activates the average detector.

In contrast to the rms detector, the average detector supplies the linear average of all sampled level values during the sweep of a pixel.

The same relations as for the rms detector apply (see above).

IEC/IEEE-bus command DET AVER



The *DETECTOR QPK* softkey activates the quasipeak detector.

This detector evaluates the sampled level values during the sweep of a pixel like an analog voltmeter.

On switching the quasipeak detector on the video bandwidth is automatically set to 10 MHz so as to exclude the influence of the video filter on the signal evaluation.

IEC/IEEE-bus command DET QPE

Mathematical Functions for Traces

TRACE 1-TRACE MATH submenu:

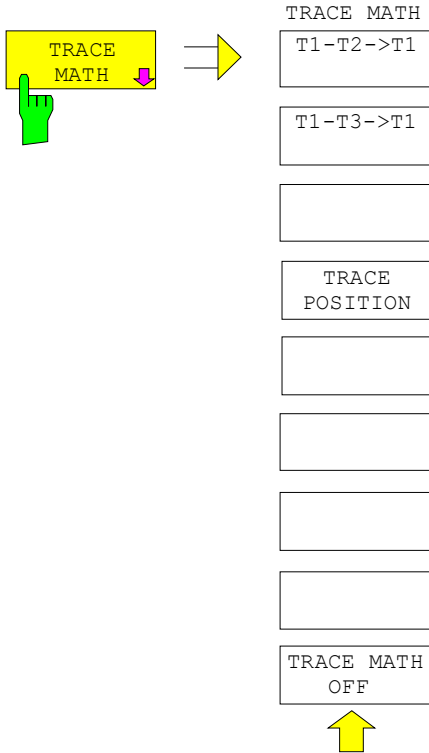

The *TRACE MATH* softkey opens a submenu in which the difference between the selected trace to trace 1 is calculated. The softkey is highlighted if a math function is activated.

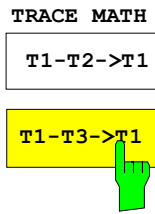

The *T1-T2* and *T1-T3* softkeys subtract the corresponding traces. The result displayed is referred to the zero point defined by *TRACE POSITION*.

To indicate that the trace has been obtained by subtraction, the difference "1 - 2" or "1 - 3" is indicated on the trace info of trace 1 and in the *TRACE* main menu the *TRACE MATH* softkey is highlighted.

IEC/IEEE-bus command `CALC:MATH (TRACE1-TRACE2)`
`CALC:MATH (TRACE1-TRACE3)`



The *TRACE POSITION* softkey activates the entry of the trace position for 0 difference. The position is stated in % of the diagram height. The range of values extends from -100% to +200%

IEC/IEEE-bus command `DISP:MATH:POS 50PCT`

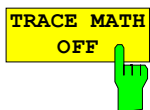

The *TRACE MATH OFF* softkey switches the math function off.

IEC/IEEE-bus command `CALC:MATH:STAT OFF`

Recording the Correction Data of FSP – CAL Key

The FSP obtains its high measurement accuracy through its inbuilt self-alignment method.

The correction data and characteristics required for the alignment are determined by comparison of the results at different settings with the known characteristics of the high-precision calibration signal source of FSP at 128 MHz. The correction data are then available in the instrument as a file and can be displayed by means of the *CAL RESULTS* softkey.

For service purposes the use of correction data can be deactivated by means of the *CAL CORR ON/OFF* softkey. If the correction data recording is aborted, the last complete correction data set is restored.

Note: *The term "Calibration" formerly used for the integrated self alignment was often mistaken for the "true" calibration of the instrument at the test set in production and in service. It is therefore no longer used although it appears in the abbreviated form in the name of keys ("CAL...").*

CAL menu:

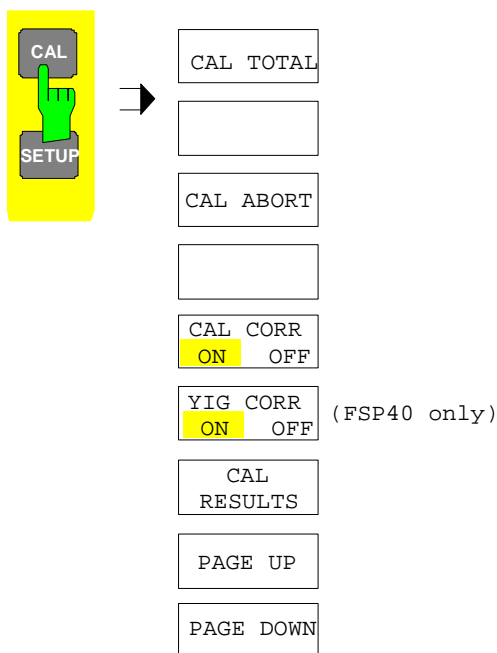

The *CAL* key opens a menu with the available functions for recording, displaying and activating the data for self alignment.

Note: *The YIG CORR ON/OFF softkey is available only on model R&S FSP40.*



The *CAL TOTAL* softkey starts the recording of correction data of the instrument.

If the correction data recording has failed or if the correction values are deactivated (*CAL CORR = OFF* softkey), the status field indicates

UNCAL

IEC/IEEE-bus command: *CAL?



The *CAL ABORT* softkey interrupts the recording of correction data and restores the last complete correction data set.

IEC/IEEE-bus command: `CAL:ABOR`

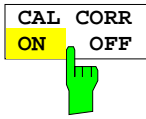

The *CAL CORR ON/OFF* softkey switches the calibration data on/off.

ON The status message depends upon the results of the total calibration.

OFF The message *UNCAL* appears in the status line.

IEC/IEEE-bus command: `CAL:STAT ON`



The *YIG CORR ON/OFF* softkey switches on or off the automatic, cyclic correction of the temperature-dependent frequency drift of the YIG filter.

When switched to ON (default setting), it is checked once per minute whether a frequency correction for the YIG filter is required. Frequency correction is performed if the temperature has changed by more than 5K relative to the last instance of correction.

Note: *If the instrument is operated in a temperature-controlled environment, the cyclic frequency drift correction can – for time-critical applications – be switched off after an operating period of ≥ 30 minutes.*

This function is available only on model R&S FSP40.

IEC/IEEE-bus command:

`:[SENSe<1|2>:]CORRection:YIG:TEMPerature:AUTO ON | OFF`

The *CAL RESULTS* softkey calls the *CALIBRATION RESULTS* table, which shows the correction data found during calibration.

The *CALIBRATION RESULTS* table contains the following information:

- date and time of last record of correction values Korrekturwertaufnahme
- overall results of correction value record
- list of found correction values according to function/module

The results have the following meaning:

PASSED	calibration successful without any restrictions
CHECK	deviation of correction value larger than expected, correction could however be performed
FAILED	deviations of correction value too large, no correction was possible. The found correction data are not valid.
ABORTED	calibration aborted

CALIBRATION RESULTS			
Total Calibration Status: PASSED			
Rohde&Schwarz,FSU-3,823156/001,1.21			
Date (dd/mm/yyyy): 09/10/2000 Time: 13:45:06			
Runtime: 05:28			
Linear Detector Offset [%]			
-2.81			
LC-Centerfrequencies			
LC-Cycle	DAC [%]	Error[kHz]	
0	42.33	-1.60	PASSED
1	46.04	-1.60	PASSED
2	45.27	0.00	PASSED
3	38.88	-1.60	PASSED
4	39.81	1.60	PASSED
Bandwidths and Centerfrequencyoffsets			
RBW	DAC [%]	E [RBW %]	

IEC/IEEE-bus command: CAL:RES?

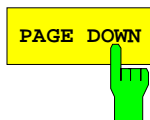

The softkeys *PAGE UP* and *PAGE DOWN* scroll one page forward or backward in the *CALIBRATION RESULTS* table. They have no function when the table is closed.

IEC/IEEE-bus command: --

Markers and Delta Markers – MKR Key

The markers are used for marking points on traces, reading out measurement results and for quickly selecting a display section. FSP provides four markers per display window. All markers can be used either as markers or delta markers. The availability of marker functions depends on whether the measurement is performed in the frequency, time or level domain.

The marker that can be moved by the user is defined in the following as the **active marker**.

Examples of marker display:

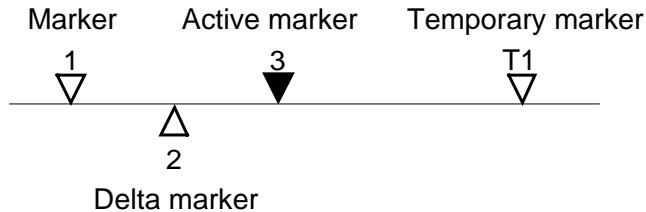

Temporary markers are used in addition to the markers and delta markers to evaluate the measurement results. They disappear when the associated function is deactivated.

The measurement results of the active marker (also called **marker values**) are displayed in the marker field. The marker info field at the upper right of the display shows the marker location (here, frequency), the level and the currently selected trace [T1].

MARKER 1 [T1]
 -27.5 dBm
 123.4567 MHz

The **MKR** key calls a menu that contains all marker and delta marker standard functions. If no marker is active, **MARKER 1** will be enabled and a peak search on the trace carried out. Otherwise, the data entry for the marker activated last is opened.

MKR menu:

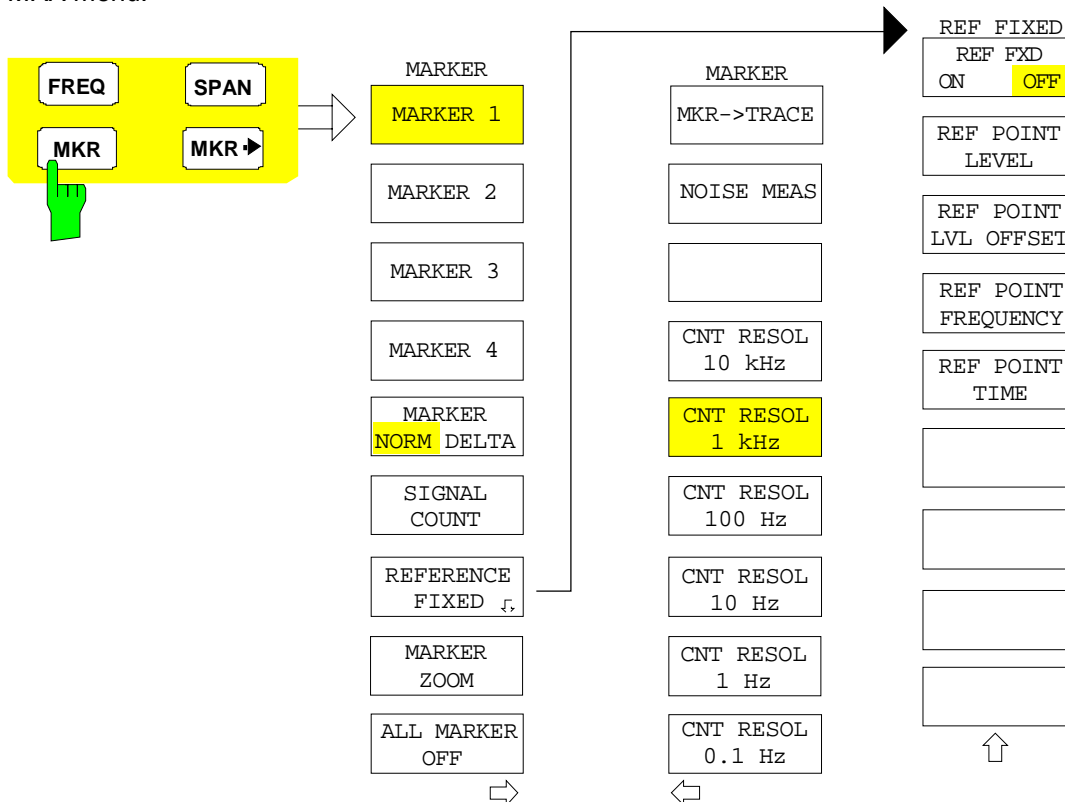

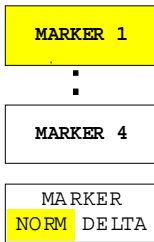

The *MARKER 1/2/3/4* softkey selects the corresponding marker and activates it.

MARKER 1 is always the normal marker. After they have been switched on, *MARKERS 2 to 4* are delta markers that refer to *MARKER 1*. These markers can be converted into markers with absolute value display by means of the *MARKER NORM DELTA* softkey. When *MARKER 1* is the active marker, pressing the *MARKER NORM DELTA* softkey switches on an additional delta marker.

Pressing the *MARKER 1 to 4* softkey again switches off the selected marker.

Example:

[PRESET] FSP is set to the default setting.

[MKR] On calling the menu, *MARKER 1* is switched on ('1' highlighted in the softkey) and positioned on the maximum value of the trace. It is a normal marker and the *MARKER NORMAL* softkey is highlighted.

[MARKER 2] *MARKER 2* is switched on ('2' highlighted in the softkey). It is automatically defined as a delta marker on switching on so the *DELTA* is highlighted on softkey *MARKER NORM DELTA*. The frequency and level of *MARKER 2* with reference to *MARKER 1* are output in the marker info field.

[MARKER NORM DELTA] The *MARKER NORM DELTA* softkey is highlighted. *MARKER 2* becomes a normal marker. The frequency and level of *MARKER 2* are output as absolute values in the marker info field.

[MARKER 2] *MARKER 2* is switched off. *MARKER 1* is the active marker for entry. The frequency and level of *MARKER 1* are output in the marker info field.

IEC/IEEE-bus command:

```

CALC:MARK ON;
CALC:MARK:X <value>;
CALC:MARK:Y?

CALC:DELT ON;
CALC:DELT:MODE ABS|REL
CALC:DELT:X <value>;
CALC:DELT:X:REL?
CALC:DELT:Y?

```

When several traces are being displayed, the marker is set to the maximum value (peak) of the active trace which has the lowest number (1 to 3). In case a marker is already located there, it will be set to the frequency of the next lowest level (next peak).

When the split-screen display mode is active, the marker will be placed in the active window. A marker can only be enabled when at least one trace in the corresponding window is visible.

If a trace is turned off, the corresponding markers and marker functions are also deactivated. If the trace is switched on again (*VIEW, CLR/WRITE;..*), the markers along with coupled functions will be restored to their original positions provided the markers have not been used on another trace.

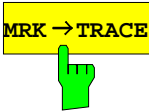

The *MKR*→*TRACE* softkey places the marker on a new trace. The trace is selected via a data entry field. Only those traces can be selected which are visible on the screen in the same window.

Example:

Three traces are presented on the screen. The marker is always on Trace 1 on switching on.

[*MKR* →*TRACE*]
"2"<*ENTER*>

The marker jumps to Trace 2 but remains on the previous frequency or time.

[*MKR* →*TRACE*]
"3"<*ENTER*>

The marker jumps to Trace 3. '

IEC/IEEE-bus command: *CALC:MARK1:TRAC 1*
 CALC:DELT:TRAC 1

Frequency Measurement with the Frequency Counter

In order to accurately determine the frequency of a signal, FSP is equipped with a frequency counter which measures the frequency of the RF signal at the intermediate frequency. Using the measured IF, FSP calculates the frequency of the RF input signal by applying the known frequency conversion factors.

The frequency measurement error depends only upon the accuracy of the frequency standard used (external or internal reference). Although FSP always operates synchronously irrespective of the set span, the frequency counter delivers a more exact result than a measurement performed with a marker. This is due to the following:

- The marker measures only the position of the pixel on the trace and infers the frequency of the signal from this value. The trace, however, contains only a limited number of pixels. Depending upon the selected span, each pixel may contain many measurement values, which therefore limits the frequency resolution.
- The resolution with which the frequency can be measured is proportional to the measurement time. For this reason, the bandwidth is normally made as wide as possible and the sweep time as short as possible. This results in a loss of frequency resolution.

For the measurement with the frequency counter, the sweep is stopped at the reference marker, the frequency is counted with the desired resolution and then the sweep is allowed to continue.

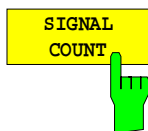

The *SIGNAL COUNT* softkey switches the frequency counter on/off.

The frequency is counted at the position of the reference marker (*MARKER 1*). The sweep stops at the reference marker until the frequency counter has delivered a result. The time required for a frequency measurement depends on the selected frequency resolution. The resolution is set in the side menu.

If no marker is enabled when the *SIGNAL COUNT* softkey is pressed, *MARKER 1* is switched on and set at the largest signal.

In addition, the *SIGNAL COUNT* function is displayed in the marker info field on the screen with [Tx CNT].

```
MARKER 1 [Tx CNT]
-27.5 dBm
23.4567891 MHz
```

Switching the *SIGNAL COUNT* function off is accomplished by pressing the softkey again.

IEC/IEEE-bus command: `CALC:MARK1:COUN ON;`
 `CALC:MARK:COUN:FREQ?`

MARKER NEXT menu

The resolution of the frequency counter is set in the *NEXT* menu of the *MARKER* menu. FSP offers counter resolutions between 0.1 Hz and 10 kHz.

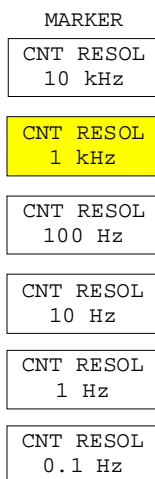

The *CNT RESOL ...* softkeys select the counter resolution. They are selection switches, i.e. only one of the can be active at any one time.

The marker stop time, ie the frequency measurement time, depends on the selected resolution.

IEC/IEEE-bus command: `CALC:MARK1:COUN:RES <value>`

Measurement example:

The frequency of a CW signal is to be determined by means of the frequency counter with a resolution of 10 Hz.

[PRESET] FSP is set to the default setting.

[MARKER] *MARKER 1* is switched on and set to the maximum value of the displayed spectrum.

[*SIGNAL COUNT*] The frequency counter is switched on. FSP counts the frequency of the signal at the marker position with a resolution of 1 kHz. The counted frequency is indicated in the marker info field.

[*NEXT*] Changes to the submenu for setting the counter resolution.

[*CNT RESOL 10 Hz*] The frequency counter resolution is increased to 10 Hz.

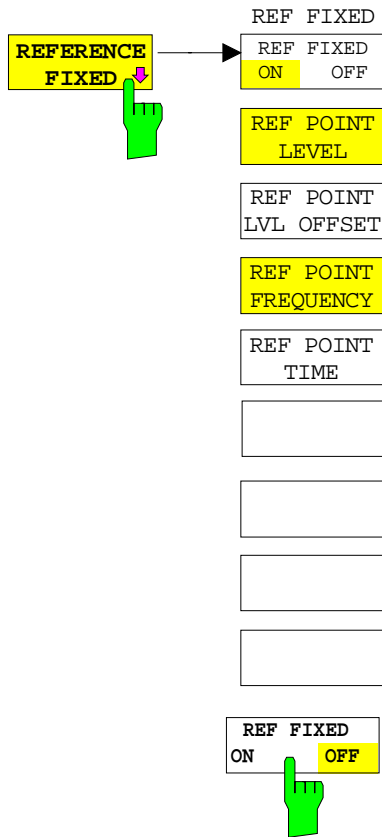

The *REFERENCE FIXED* softkey defines the level and the frequency or time of *MARKER 1* as a reference for one or several delta markers. The measured values for one or several markers displayed in the marker info field are derived from this reference point instead of the current values of the reference marker (*MARKER 1*).

On actuating the softkey, reference fixed is switched on and thus, the level value and the frequency, time or x-level value of *MARKER 1* immediately become the reference point.

Additionally, the *REFERENCE FIXED* softkey opens the sub-menu where it is possible to determine manually a reference point with level and frequency, time or x-axis level, to define a level offset or deactivate the reference point.

The *REFERENCE FIXED* function is useful for the measurement of the harmonic suppression at small span (fundamental not represented).

The *REF FXD ON/OFF* softkey switches on or off the relative measurement to a fixed reference value (*REFERENCE POINT*) independent of the trace.

IEC/IEEE-bus command: `CALC:DELT2:FUNC:FIX ON`

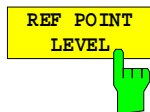

The *REF POINT LEVEL* softkey enters a reference level independent of the reference marker level. All relative level values of the delta markers refer to this reference level.

IEC/IEEE-bus command:
`CALC:DELT2:FUNC:FIX:RPO:Y -10dBm`



The *REF POINT LVL OFFSET* softkey specifies a level offset relevant to the reference level. The relative level values of the delta markers refer to the reference point level plus the level offset.

The level offset is set to 0 dB on enabling the *REFERENCE FIXED* or *PHASE NOISE* function.

IEC/IEEE-bus command:
`CALC:DELT2:FUNC:FIX:RPO:Y:OFFS 0dB`

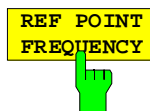

With the *REF POINT FREQUENCY* softkey a reference frequency can be manually activated for the delta markers when the *REFERENCE FIXED* or *PHASE NOISE* function is used.

IEC/IEEE-bus command:
`CALC:DELT2:FUNC:FIX:RPO:X 10.7MHz`



The *REF POINT TIME* softkey activates the entry box for the input of a reference time for the *REFERENCE FIXED* function in the time domain (span = 0 Hz).

IEC/IEEE-bus command:

```
CALC:DELT2:FUNC:FIX:RPO:X 5MS
```

For phase noise measurement, input of reference time is not possible.

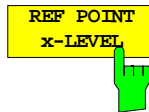

The *REF POINT x-LEVEL* softkey activates the entry box for the input of a reference level on the x-axis for the *REFERENCE FIXED* function when the power sweep is active.

IEC/IEEE-bus command:

```
CALC:DELT2:FUNC:FIX:RPO:X -5DBM
```

Measurement example:

Small-span harmonics measurement to increase sensitivity
CW signal (eg 100 MHz, 0 dBm) with harmonics at the RF input of FSP.

[PRESET]	FSP is set to the default setting.
[CENTER: 100 MHz]	The center frequency of FSP is set to 100 MHz.
[SPAN: 1 MHz]	The span is set to 1 MHz.
[AMPL: 3 dBm]	The reference level is set to 3 dBm (3 dB above the expected RF level).
[MKR]	<i>MARKER 1</i> is switched on ('1' highlighted in the softkey) and set to the signal peak.
[MARKER 2]	<i>MARKER 2</i> is switched on and automatically defined as the delta marker (<i>DELTA</i> is highlighted on <i>MARKER NORM DELTA</i> softkey).
[REFERENCE FIXED]	The frequency and level of <i>MARKER 1</i> are a reference for the delta marker.
[CENTER: 200 MHz]	The center frequency is set to 200 MHz (= frequency of the 2nd harmonic). The reference level may have to be reduced to see the 2nd harmonic from the noise. This does not affect the reference level set with <i>REFERENCE FIXED</i> .
[MKR->: PEAK]	The delta marker jumps to the 2nd harmonic of the signal. The level spacing of the harmonic to the fundamental is displayed in the marker info field.

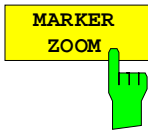

The *MARKER ZOOM* softkey expands the area around *MARKER 1*. With the zoom function, more details of the spectrum can be seen. The desired display range can be defined in an entry window.

The following sweep is stopped at the position of the reference marker. The frequency of the signal is counted and the measured frequency becomes the new center frequency. The zoomed display range is then configured and the new settings are used by FSP for further measurements.

As long as switching to the new frequency display range has not yet taken place, pressing the softkey will abort the procedure.

If *MARKER 1* is not active when the softkey is pressed, it is automatically activated and set to the highest peak in the window.

If an instrument setting is changed after selection of *MARKER ZOOM*, the function is aborted.

The *MARKER ZOOM* softkey is only available in the frequency domain (span > 0).

IEC/IEEE-bus command: `CALC:MARK1:FUNC:ZOOM 1kHz`



The *ALL MARKER OFF* softkey switches off all markers (reference and delta markers). It also switches off all functions and displays associated with the markers/delta markers.

IEC/IEEE-bus command: `CALC:MARK:AOFF`

Marker Functions – MKR FCTN Key

The MKR FCTN menu offers further measurements with the markers:

- Measurement of noise density (*NOISE MEAS* softkey)
- Measurement of phase noise (*PHASE NOISE* softkey)
- Measurement of filter or signal bandwidth (*N DB DOWN* softkey)
- Activating of AF demodulation (*MARKER DEMOD* softkey)

On calling the menu, the entry for the last active marker is activated (*SELECT MARKER* softkey); if no marker is activated, marker 1 is activated and a maximum search (*PEAK SEARCH* softkey) is performed. The marker can be set to the desired trace by means of *MKR -> TRACE* softkey.

Menu *MKR FCTN*:

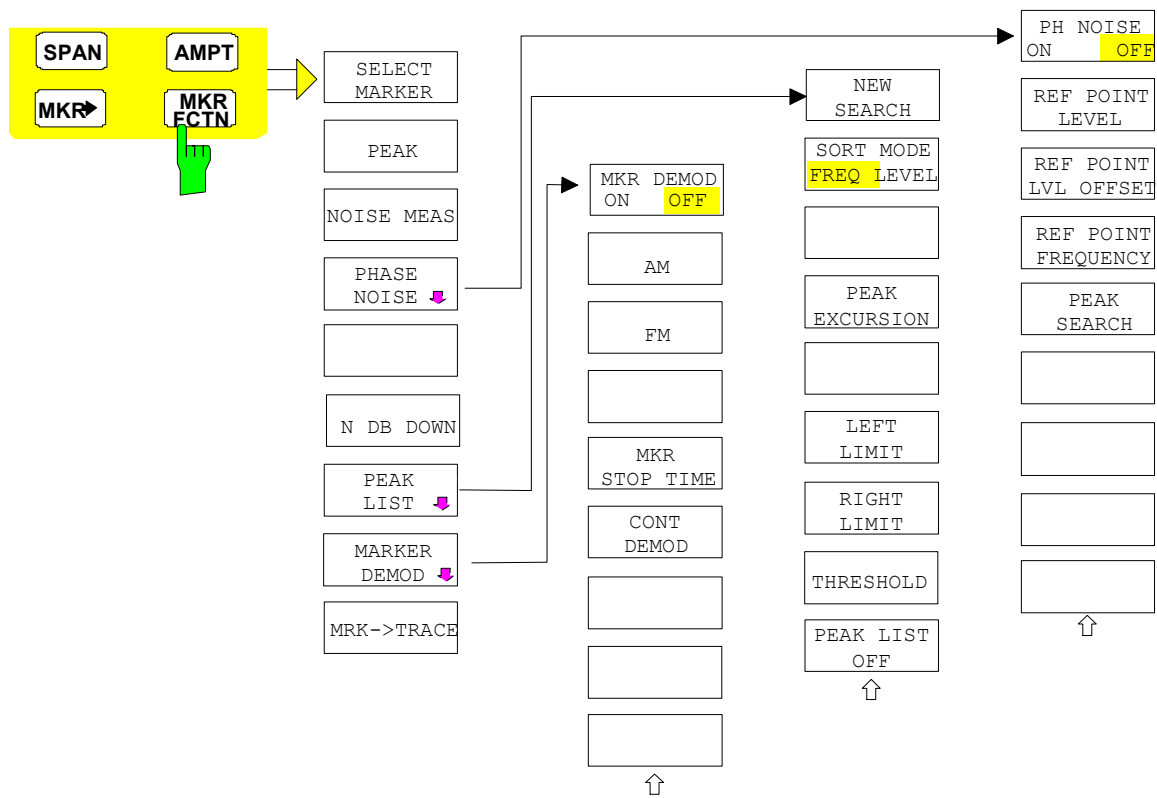

Activating the Markers

Menu MKR FCTN:

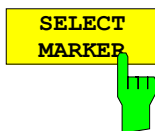

The *SELECT MARKER* softkey activates the numerical selection of the marker in the data entry field. Delta marker 1 is selected by input of '0'. If the marker is switched off, then it is switched on and can be moved later on.

IEC/IEEE-bus command: `CALC:MARK1 ON;`
`CALC:MARK1:X <value>;`
`CALC:MARK1:Y?`

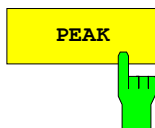

The *PEAK* softkey sets the active marker/delta marker to the peak of the trace.

IEC/IEEE-bus command: `CALC:MARK1:MAX`
`CALC:DELT1:MAX`

Measurement of Noise Density

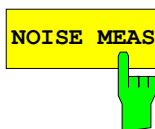

The *NOISE MEAS* softkey switches the noise measurement for the active marker on or off. The corresponding marker becomes the *NORMAL* marker.

During noise measurement, the noise power density is measured at the position of the marker. In the time domain mode, all points of the trace are used to determine the noise power density. When measurements are performed in the frequency domain, two points to the right and left of the marker are used for the measurement to obtain a stable result.

The noise power density is indicated in the marker field. With a logarithmic amplitude units (dBm, dBmV, dBm μ V, dB μ A) the noise power density is output in dBm/Hz i.e. as level in 1 Hz bandwidth with reference to 1 mW. With linear amplitude units (V, A, W) the noise voltage density is evaluated in μ V/ \sqrt Hz, the noise current density in μ A/ \sqrt Hz or the noise power density in μ W/Hz.

The following settings have to be made to ensure that the power density measurement yields correct values:

Detector: Sample or RMS

Video bandwidth:

- ≤ 0.1 x resolution bandwidth with sample detector
(corresponds to RBW / VBW NOISE)
- ≥ 3 x resolution bandwidth with RMS detector
(corresponds to RBW / VBW SINE)

In the default setting, the FSP uses the sample detector for the noise function.

With the sample detector, the trace can additionally be set to AVERAGE to stabilize the measured values. With RMS detector used, trace averaging must not be used since in this case it produces too low noise levels which cannot be corrected. Instead, the sweep time can be increased to obtain stable measurement results.

The FSP uses the following correction factors to evaluate the noise density from the marker level:

- Since the noise power is indicated with reference to 1 Hz bandwidth, the bandwidth correction value is deducted from the marker level. It is $10 \times \lg(1 \text{ Hz}/\text{BW}_{\text{Noise}})$, where BW_{Noise} is the noise or power bandwidth of the set resolution filter (RBW).

Sample detector:

- As a result of video filter averaging and trace averaging, 1.05 dB is added to the marker level. This is the difference between the average value and the RMS value of white noise.
- With a logarithmic level axis, 1.45 dB is added additionally. Logarithmic averaging is thus fully taken into account which yields a value that is 1.45 dB lower than that of linear averaging.

RMS detector:

- With the exception of bandwidth correction, no further corrections are required for the RMS detector since it already indicates the power with every point of the trace.

To allow a more stable noise display the adjacent (symmetric to the measurement frequency) points of the trace are averaged.

In time domain mode, the measured values are averaged versus time (after a sweep).

IEC/IEEE-bus command: `CALC:MARK:FUNC:NOIS ON;`
 `CALC:MARK:FUNC:NOIS:RES?`

Example: Measurement of inherent FSP noise

- [PRESET]** The FSP is set to default setting.
- [MARKER]** Marker 1 is switched on and set to the maximum value of the displayed spectrum. Set marker to desired frequency using the rotary knob.
- [NOISE]** The FSP switches the sample detector on and sets the video bandwidth to 300 kHz (0.1 x RBW). The power density level of inherent noise is displayed in dBm/Hz in the marker info field.

Note: *The FSP noise figure can be calculated from the measured power density level. It is calculated by deducting the set RF attenuation (RF Att) from the displayed noise level. 174 is to be added to the result to obtain the FSP noise figure.*

Phase Noise Measurement

Menu MKR FCTN:

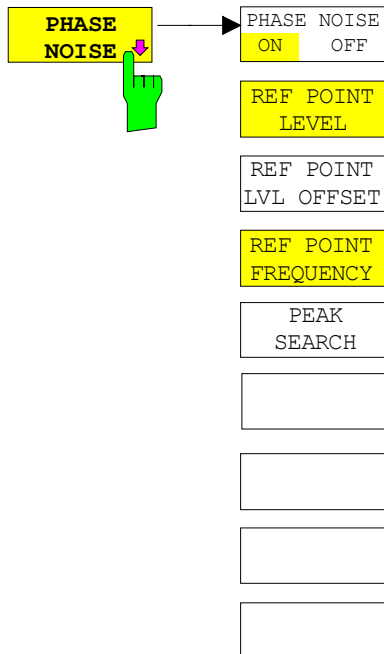

The *PHASE NOISE* softkey switches the *PHASE NOISE* function on/off. Additionally, the softkey opens the submenu for manually setting the reference point. The phase noise measurement can be switched off in the submenu.

MARKER 1 (= reference marker) is used as a reference for the phase noise measurement. The frequency and level of the reference marker are used as fixed reference values, i.e. the *REFERENCE FIXED* function is activated. After switching on the phase noise measurement the reference level or the center frequency can thus be set in a way that the carrier is outside the displayed frequency range, or, for example, a notch filter is switched on to suppress the carrier.

A noise power density measurement is carried out with the delta marker or delta markers. This measurement corresponds to the *NOISE* function in the *MARKER* menu (*MKR*). The result of the phase noise measurement is the difference in level between the reference point and the noise power density.

The following possibilities can be selected on switching on *PHASE NOISE*:

1. No marker enabled:

[**MKR FCTN**] *MARKER 1* is enabled and set to peak.
 [*PHASE NOISE*] *MARKER 1* becomes the reference marker, *MARKER 2* the delta marker; frequency = frequency of the reference marker. The delta marker is the active marker, i.e. it can be moved with the rollkey or adjusted by entering numerals. The *PHASE NOISE* function is switched on and the measured value is output.

2. Markers are enabled:

[**MKR FCTN**] The previous marker configuration remains unchanged.
 [*PHASE NOISE*] *MARKER 1* becomes the reference marker. If other markers are enabled, they become delta markers and measure the phase noise at their respective positions.

If further markers are enabled during the phase noise measurement, they automatically become delta markers and measure the phase noise at their respective positions.

When the phase noise measurement is switched off, the marker configuration remains unchanged and the delta markers measure the relative level to the reference marker (*MARKER 1*).

The *PHASE NOISE* function measures the noise power at the delta markers referred to 1 Hz bandwidth. The sample detector is automatically used and the video bandwidth set to 0.1 times the resolution bandwidth (RBW). The two settings are taken into account in the correction values used for the noise power measurement.

To obtain stable results, two pixels on the right and the left of the respective delta marker position are taken for the measurement. The procedure for determining the noise power is identical to the method used for the noise power measurement (see *NOISE* softkey). The measured noise level referred to 1 Hz bandwidth is subtracted from the carrier level at the reference marker (*MARKER 1*). The measured values are displayed in the delta marker field in dBc/Hz (= spacing in dB of the noise power from the carrier level in 1 Hz bandwidth).

If several delta markers are enabled, only the value read by the active marker is shown in the marker field. If several delta markers are active, their measurement results are shown in the marker info field.

The reference value for the phase noise measurement can be defined with *REF POINT LEVEL*, *REF POINT FREQUENCY* and *REF POINT LVL OFFSET* to differ from that of the reference marker.

IEC/IEEE-bus command: --

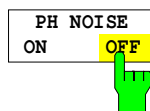

The *PH NOISE ON/OFF* softkey switches on/off the phase noise measurement. Switching on is performed by means of the *PHASE NOISE* softkey and is only necessary when the phase noise measurement has been switched off in the submenu.

IEC/IEEE-bus command: `CALC:DELT1:FUNC:PNO ON`
`CALC:DELT1:FUNC:PNO:RES?`

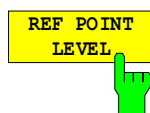

The *REF POINT LEVEL* softkey activates an entry box for the input of a reference level other than the reference marker level. The function is identical to that of the softkey with the same name in the marker menu (*MKR*).

IEC/IEEE-bus command: `CALC:DELT1:FUNC:FIX:RPO:Y -10dB`



The *REF POINT LVL OFFSET* softkey activates an entry box for the input of an additional level offset for the phase noise calculation.

This level offset is set to 0 dB on when the *REFERENCE FIXED* or *PHASE NOISE* function is enabled.

IEC/IEEE-bus command: `CALC:DELT:FUNC:FIX:RPO:Y:OFFS 10dB`

REF POINT
FREQUENCY

The *REF POINT FREQUENCY* softkey activates an entry box for the manual input of a reference frequency for the *REFERENCE FIXED* or *PHASE NOISE* function.

IEC/IEEE-bus command:

```
CALC:DELT1:FUNC:FIX:RPO:X 10.7MHz
```

PEAK
SEARCH

The *PEAK SEARCH* sets the reference point level for delta marker 2 in the selected measurement window to the peak of the selected trace.

IEC/IEEE-bus command: `CALC:DELT:FUNC:FIX:RPO:MAX`

Measurement example:

The phase noise of a CW signal at 100 MHz with 0 dBm level is to be measured at 800 kHz from the carrier

[PRESET]	The FSP is set to the default setting.
[CENTER: 100 MHz]	The center frequency is set to 100 MHz.
[SPAN: 2 MHz]	The span is set to 2 MHz.
[AMPT: 0 dBm]	The reference level is set to 0 dBm.
[MKR FCTN]	<i>MARKER 1</i> is switched on and positioned at the maximum of the displayed trace.
[PHASE NOISE: 800 kHz]	The phase noise measurement is switched on. The delta marker is positioned on the main marker and the measured phase noise value is displayed in the marker info field. The sample detector is used and the video bandwidth is set to 3 x RBW. When the phase noise measurement function is enabled, the entry of the delta marker frequency is activated. It can be entered directly.

Measurement of the Filter or Signal Bandwidth

Menu *MKR FCTN*:

N dB DOWN



The *N dB DOWN* softkey activates the temporary markers T1 and T2 which are n dB below the active reference marker. Marker T1 is placed to the left and marker T2 at the right of the reference marker. The value n can be input in a window.

The default setting is 3 dB.

Span > 0: The frequency spacing of the two temporary markers is indicated in the marker info field.

Span = 0: The pulse width between the two temporary markers is indicated in the marker info field.

If, for example, it is not possible to form the frequency spacing for the n dB value because of the noise display, dashes are indicated instead of a measured value.

IEC/IEEE-bus command: `CALC:MARK1:FUNC:NDBD:STAT ON`

```
CALC:MARK1:FUNC:NDBD 3dB
```

```
CALC:MARK1:FUNC:NDBD:RES?
```

```
CALC:MARK1:FUNC:NDBD:FREQ? 'Span > 0
```

```
CALC:MARK1:FUNC:NDBD:TIME? 'Span = 0
```

Measurement of a Peak List

Menu *MKR FCTN*:

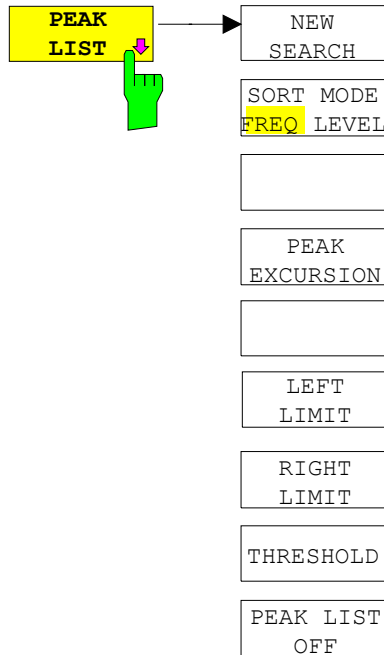

The *PEAK LIST* softkey allows the peak values of the trace to be determined and entered in a list with 50 entries max. The order of the entries is defined by the *SORT MODE*:

FREQ sorting in ascending order of frequency values (see screenshot); if span = 0, the entries are sorted in ascending order of time values

LEVEL sorting according to level

PEAK LIST		
#	FREQUENCY	POWER
1	794.871794871 MHz	-55.37 dBm
2	2.397435897 GHz	-74.70 dBm
3	4.012820512 GHz	-38.00 dBm
4	5.615384615 GHz	-26.04 dBm
5	6.435897435 GHz	-38.02 dBm
6	7.217948717 GHz	-55.39 dBm

The search range can be restricted by means of the *LEFT LIMIT*, *RIGHT LIMIT* and *THRESHOLD* softkeys. The definition of the peak values can be modified using the *PEAK EXCURSION* softkey. The *MKR->TRACE* softkey in the main menu is used to select the trace for searching peak values.

Opening the list performs a single search at the end of the sweep. The *NEW SEARCH* softkey triggers a new sweep, determines the peak values of the trace at the end of the sweep and enters them in the list.

Use the *PEAK LIST OFF* key to delete the list from the screen.

```

IEC/IEEE-bus commands: INIT:CONT OFF;
                        CALC:MARK:TRAC 1;
                        CALC:MARK:FUNC:FPE:SORT X;
                        INIT;*WAI;
                        CALC:MARK:FUNC:FPE 10;
                        CALC:MARK:FUNC:FPE:COUN?;
                        CALC:MARK:FUNC:FPE:Y?;
                        CALC:MARK:FUNC:FPE:X?
  
```



The *NEW SEARCH* softkey starts a new peak search and enters the results in the peak list.

IEC/IEEE-bus commands: `INIT;*WAI;`
`CALC:MARK:FUNC:FPE 10;`
`CALC:MARK:FUNC:FPE:COUN?;`
`CALC:MARK:FUNC:FPE:Y?;`
`CALC:MARK:FUNC:FPE:X?`



The *SORT MODE FREQ/LEVEL* softkey defines the position of the peak values in the list:

FREQ sorting in ascending order of frequency values (time values if span = 0)
LEVEL sorting according to level

IEC/IEEE-bus command: `CALC:MARK:FUNC:FPE:SORT X;`

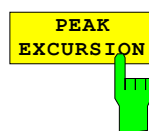

With level measurements, the *PEAK EXCURSION* softkey allows the minimum amount to be entered by which a signal must decrease or increase in order to be recognized as a maximum by the peak search function.

Values between 0 dB and 80 dB may be entered, the resolution being 0.1 dB

IEC/IEEE-bus command: `CALC:MARK:PEXC 6dB`

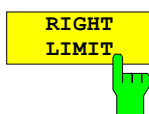
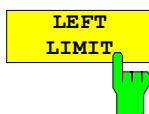

The *LEFT LIMIT* and *RIGHT LIMIT* softkeys define the vertical lines F1/F2 in the frequency domain (span > 0) and T1/T2 in the time domain (span = 0) between which the search is carried out. If only one line is active, the F1/T1 line is used as the lower limit; the upper limit is the stop frequency. If F2/T2 is also active, it defines the upper limit.

IEC/IEEE-bus commands: `CALC:MARK:X:SLIM:LEFT 1MHZ`
`CALC:MARK:X:SLIM:RIGH 10MHZ`
`CALC:MARK:X:SLIM ON`



The *THRESHOLD* softkey defines a horizontal threshold line which represents the lower limit of the peak search level range.

IEC/IEEE-bus command: `CALC:THR -20dBm`
`CALC:THR ON`



The *PEAK LIST OFF* softkey switches off the table with the search results.

IEC/IEEE-bus command: `-`

AF Demodulation

The FSP provides demodulators for AM and FM signals when equipped with the AF demodulator option (FSP-B3). With these demodulators, a displayed signal can be identified acoustically through the use of the internal loudspeaker or with headphones. The frequency at which the demodulation is enabled is coupled to the markers. The sweep stops at the frequency determined by the active marker for the selected time and the RF signal is demodulated. During a measurement in the time domain (span = 0 Hz) the demodulation is continuously on.

The threshold line (*MKR->SEARCH LIMITS:THRESHOLD*) performs a squelch function in the demodulator. If the threshold is set, the FSP LF demodulation is switched on only when the signal to be demodulated exceeds the set threshold.

Menu *MKR FCTN*:

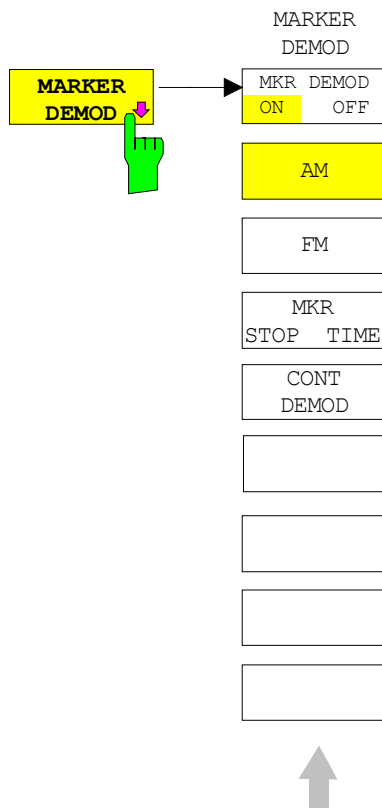

The *MARKER DEMOD* softkey switches on the audio demodulator and calls a submenu in which the demodulation mode and the duration of the demodulation can be selected.

IEC/IEEE-bus command: `CALC:MARK1:FUNC:DEM ON`

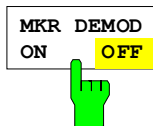

The *MKR DEMOD ON/OFF* softkey switches the demodulation on/off.

In the frequency range (span >0), the frequency scan is stopped at the frequency of the active marker with demodulation switched on – provided that the level is above the threshold line - and the signal is demodulated during the given stop time.

In the time domain (span = 0) demodulation is continuous, i.e. not only active at the marker position.

IEC/IEEE-bus command: `CALC:MARK1:FUNC:DEM ON`

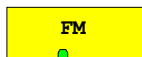
The softkeys *AM* and *FM* are selector switches one of which only may be active at a time. They set the desired demodulation mode FM or AM. Default setting is AM.

IEC/IEEE-bus command: `CALC:MARK1:FUNC:DEM:SEL AM`
`CALC:MARK1:FUNC:DEM:SEL FM`

The *MKR STOP TIME* softkey defines the stop time for demodulation at the marker(s).

The FSP interrupts the frequency sweep at the marker position and activates the demodulation for the duration of the stop time (see also *MKR DEMOD ON/OFF*).

In the time domain (span = 0) the demodulation is continuously active irrespective of the stop time set.

IEC/IEEE-bus command: `CALC:MARK1:FUNC:DEM:HOLD 3s`

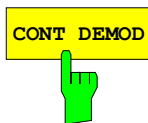

The *CONT DEMOD* softkey switches on the continuous demodulation in the frequency domain. If the sweep time is long enough, the set frequency range can be monitored acoustically.

IEC/IEEE-bus command: `CALC:MARK1:FUNC:DEM:CONT ON`

Selecting the Trace

Menu *MKR FCTN*:



The *MKR ->TRACE* softkey sets the active marker to different traces. Only those traces can be selected which are visible on the screen in the same window.

The function of the softkey is identical to that of the softkey with the same name in the *MKR->* menu.

Example:

Three traces are displayed on the screen. The marker is always on Trace 1 on switching on.

`[MKR ->TRACE]`

`"1"<ENTER>` The marker jumps to Trace 2, but remains at the previous frequency or time.

`[MKR ->TRACE]`

`"3"<ENTER>` The marker jumps to Trace 3.

IEC/IEEE-bus command: `CALC:MARK:TRAC 2`

Change of Settings via Markers – MKR ⇒ Key

The *MKR* → menu offers functions through which instrument parameters can be changed with the aid of the currently active marker. The functions can be used on markers and delta markers.

On opening the menu, the entry for the last active marker is activated; if no marker was enabled, *MARKER 1* is activated and a peak search is performed.

MKR → menu

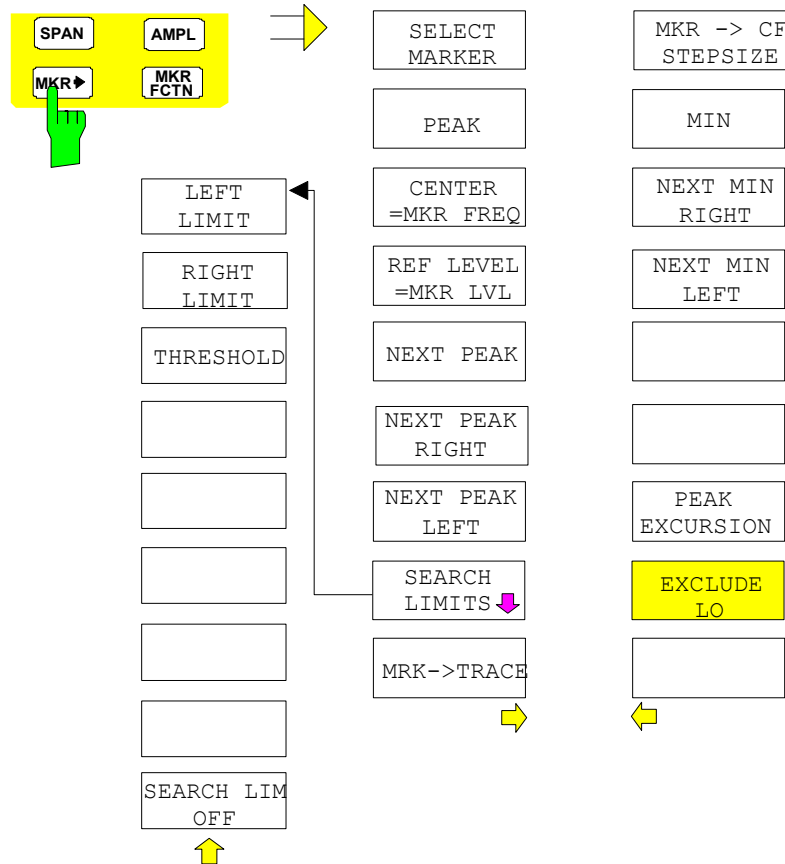

The *SELECT MARKER* softkey activates the numerical selection of the marker in the data entry field. Delta marker 1 is selected by input of '0'.

IEC/IEEE-bus commands: `CALC:MARK1 ON;`
`CALC:MARK1:X <value>;`
`CALC:MARK1:Y?`

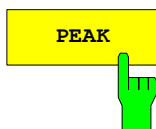

The *PEAK* softkey sets the active marker/delta marker to the peak of the trace.

If no marker is active when *MKR->* menu is called, *MARKER 1* is automatically switched on and the peak search is performed.

IEC/IEEE-bus commands: `CALC:MARK:MAX`
`CALC:DELT:MAX`



The *CENTER = MKR FREQ* softkey sets the center frequency to the current marker or delta marker frequency.
 A signal can thus be set to the center of the frequency display range, for example, so that it can then be examined in detail with a smaller span.

The softkey is not available in the time domain (zero span).

IEC/IEEE-bus command: `CALC:MARK:FUNC:CENT`

Example:

A spectrum is displayed with a large span after PRESET. A signal off the center is to be examined in detail:

- [PRESET] FSP is set to the default setting.
- [MKR->] *MARKER 1* is switched on and automatically jumps to the largest signal of the trace.
- [CENTER =MKR FREQ] The center frequency is set to the marker frequency. The span is adapted in such a way that the minimum frequency (= 0 Hz) or the maximum frequency is not exceeded.
- [SPAN] The span can, for example, be reduced using the rollkey.



The *REF LEVEL = MKR LVL* softkey sets the reference level to the current marker level.

IEC/IEEE-bus command: `CALC:MARK:FUNC:REF`

Example:

A spectrum is displayed with a large span after PRESET. A signal off the center is to be examined in detail:

- [PRESET] FSP is set to the default setting.
- [MKR->] *MARKER 1* is switched on and automatically jumps to the largest signal of the trace.
- [CENTER =MKR FREQ] The center frequency is set to the marker frequency. The span is adapted in such a way that the minimum frequency (= 0 Hz) or the maximum frequency is not exceeded.
- [REF LEVEL = MKR LVL] The reference level is set to the measured marker level.
- [SPAN] The span can, for example, be reduced using the rollkey.



The *NEXT PEAK* softkey sets the active marker/delta marker to the next lower maximum of the selected trace.

IEC/IEEE-bus commands: `CALC:MARK:MAX:NEXT`
`CALC:DELT:MAX:NEXT`

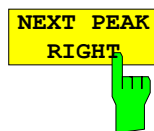

The *NEXT PEAK RIGHT* softkey sets the active marker/delta marker to the next lower maximum right of the current marker position on the selected trace.

IEC/IEEE-bus commands: `CALC:MARK:MAX:RIGH`
`CALC:DELT:MAX:RIGH`

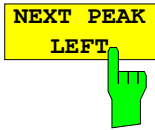

The *NEXT PEAK LEFT* softkey sets the active marker/delta marker to the next lower maximum left of the current marker position the selected trace.

IEC/IEEE-bus commands: `CALC:MARK:MAX:LEFT`
`CALC:DELT:MAX:LEFT`

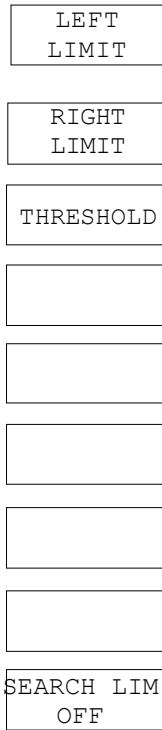
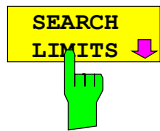

The *SEARCH LIMITS* softkey limits the search range for maximum or minimum search. The softkey switches to a submenu in which the search range limits can be set in the x and y direction.

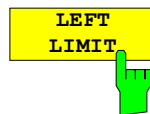

The *LEFT LIMIT* und *RIGHT LIMIT* softkeys define the two vertical lines F1 and F2 in the frequency domain (span > 0) and T1 / T2 in the time domain (span = 0). The search is performed between these lines in the frequency and time domain

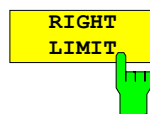

If only *LEFT LIMIT* is enabled, line F1/T1 is the lower limit and the upper limit corresponds to the stop frequency. If *RIGHT LIMIT* is also enabled, it determines the upper limit.

IEC/IEEE-bus commands: `CALC:MARK:X:SLIM:LEFT 1MHZ`
`CALC:MARK:X:SLIM:RIGH 10MHZ`
`CALC:MARK:X:SLIM ON`



The *THRESHOLD* softkey defines the threshold line. The threshold line represents a limit for the level range of the max. search at the lower end and that of the min. search at the upper end.

IEC/IEEE-bus commands: `CALC:THR -20dBm`
`CALC:THR ON`

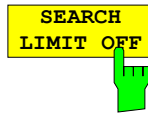

The *SEARCH LIMIT OFF* softkey disables all limits of the search range.

IEC/IEEE-bus commands: `CALC:MARK:X:SLIM OFF`
`CALC:THR OFF`

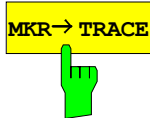

The *MKR->TRACE* softkey sets the active marker to a new trace. If only one trace is available on the screen, the softkey does not appear. If several traces are available on the screen, only these are offered.

IEC/IEEE-bus command: `CALC:MARK:TRAC 2`

Example:

Three traces are displayed on the screen. The marker is always on Trace 1 after switching on.

[*MKR ->TRACE*] "2" <ENTER> The marker jumps to Trace 2 but remains at the previous frequency or time.

[*MKR ->TRACE*] "3" <ENTER> The marker jumps to Trace 3.



The *MKR->CF STEPSIZE* softkey sets the step size for the center frequency variation to the current marker frequency, and also sets step size adaptation to *MANUAL*. *CF STEPSIZE* remains at this value until the center frequency entry mode in the STEP menu is switched from *MANUAL* to *AUTO* again.

The *MKR->CF STEPSIZE* function is, above all, useful in the measurement of harmonics with large dynamic range (narrow bandwidth and narrow span).

The softkey is not available in the time domain (span = 0 Hz).

IEC/IEEE-bus command: `CALC:MARK:FUNC:CST`

Example:

The harmonics levels of a CW carrier are to be measured at 100 MHz.

[**PRESET**] FSP is set to the default setting.

[**CENTER: 100 MHz**] FSP sets the center frequency to 100 MHz. The span is set to 200 MHz.

[**SPAN: 1 MHz**] The span is set to 100 MHz.

[**MKR->**] *MARKER 1* is switched on and set to the maximum value of the signal.

[**NEXT**] FSP switches to the submenu.

[*MKR->CF STEPSIZE*] The step size of the center frequency setting equals the marker frequency (100 MHz).

[**CENTER**] The center frequency entry mode is activated.

[**Right key**] The center frequency is set to 200 MHz. The first harmonic of the test signal is displayed.

[**MKR->: PEAK**] The marker is set to the harmonic and the level of the latter is output in the marker info field.

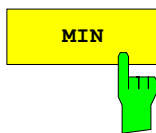

The *MIN* softkey sets the active marker/delta marker to the minimum of the selected trace.

IEC/IEEE-bus commands: `CALC:MARK:MIN`
`CALC:DELT:MIN`

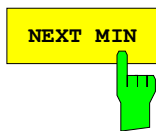

The *NEXT MIN* softkey sets the active marker/delta marker to the next higher minimum of the selected trace. The search direction is defined in the *NEXT MODE* submenu (see above).

IEC/IEEE-bus commands: `CALC:MARK:MIN:NEXT`
`CALC:DELT:MIN:NEXT`

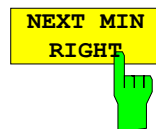

The *NEXT MIN RIGHT* softkey sets the active marker/delta marker to the next higher minimum right of the current marker position on the selected trace.

IEC/IEEE-bus commands: `CALC:MARK:MIN:RIGH`
`CALC:DELT:MIN:RIGH`



The *NEXT MIN LEFT* softkey sets the active marker/delta marker to the next higher minimum left of the current marker position on the selected trace.

IEC/IEEE-bus commands: `CALC:MARK:MIN:LEFT`
`CALC:DELT:MIN:LEFT`

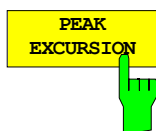

The *PEAK EXCURSION* softkey enables – for level measurements – the entry of a minimum level value by which a signal must rise or fall so that it will be identified as a maximum or a minimum by the *NEXT PEAK* and *NEXT MIN* search functions.

Valid entries are from 0 dB to 80 dB; the resolution is 0.1 dB.

IEC/IEEE-bus command: `CALC:MARK:PEXC 10dB`

The default setting for the peak excursion is 6 dB. This value is sufficient for the *NEXT PEAK* and *NEXT MIN* functions since, in this mode, the next lower maximum or next higher minimum will always be detected.

If *NEXT PEAK LEFT* or *NEXT PEAK RIGHT* is selected, these functions search for the next relative maximum left or right of the current marker position irrespective of the current signal amplitude. *Relative maximum* is understood to mean a decrease of the signal amplitude by a defined value – i.e. the peak excursion – right and left of the amplitude peak.

The 6 dB level change set as a default value may be attained already by the inherent noise of the instrument. In such a case, the R&S FSP would identify noise peaks as maxima or minima. The value entered for the *PEAK EXCURSION* should therefore be higher than the difference between the highest and the lowest value measured for the displayed inherent noise.

The following example illustrates the effect of different settings of the *PEAK EXCURSION*.

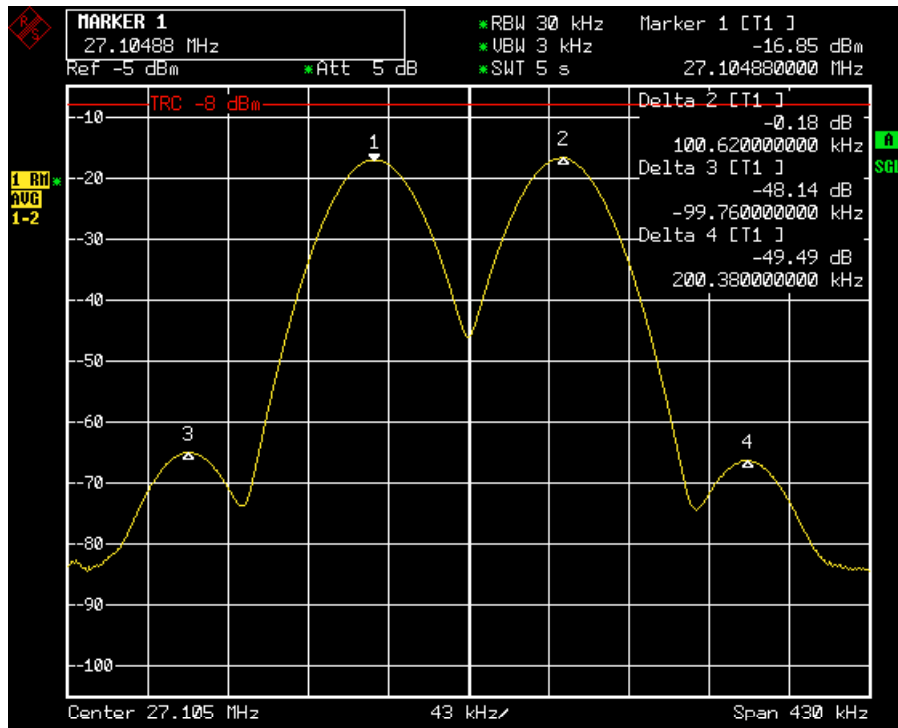

Fig. 14-1 Examples of level measurement with different settings of *PEAK EXCURSION*

The following table lists the signals as indicated by marker numbers in the diagram above, as well as the minimum of the amplitude decrease to both sides of the signal:

signal #	min. amplitude decrease to both sides of the signal
1	30 dB
2	29.85 dB
3	7 dB
4	7 dB

With **40 dB peak excursion**, NEXT PEAK, NEXT PEAK RIGHT and NEXT PEAK LEFT will not find any signal, as the signal level does not decrease by more than 30 dB to either side of any signal.

Order of signals detected:
 PEAK: signal 1
 NEXT PEAK: signal 1 (no further signal detected)
 or
 PEAK: signal 1
 NEXT PEAK LEFT: signal 1 (no further signal detected)
 NEXT PEAK RIGHT: signal 1 (no further signal detected)

With **20 dB peak excursion**, NEXT PEAK and NEXT PEAK RIGHT will also detect signal 2, as the signal level decreases at least by 29.85 dB to either side of this signal, which is now greater than the peak excursion.

Order of signals detected:

PEAK: Signal 1
 NEXT PEAK: Signal 2
 NEXT PEAK: Signal 2 (no further signal detected)

or

PEAK: Signal 1
 NEXT PEAK LEFT: Signal 1 (no further signal detected)
 NEXT PEAK RIGHT: Signal 2
 NEXT PEAK RIGHT: Signal 2 (no further signal detected)

With **6 dB peak excursion**, all signals will be detected with NEXT PEAK and NEXT PEAK RIGHT / NEXT PEAK LEFT.

Order of signals detected:

Order of signals detected:

PEAK: Signal 1
 NEXT PEAK: Signal 2
 NEXT PEAK: Signal 3
 NEXT PEAK: Signal 4

or

PEAK: Signal 1
 NEXT PEAK LEFT: Signal 3
 NEXT PEAK RIGHT: Signal 1
 NEXT PEAK RIGHT: Signal 2
 NEXT PEAK RIGHT: Signal 4

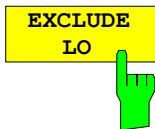

The *EXCLUDE LO* softkey limits the frequency range for the marker search functions or disables the limit.

activated Because of the feedthrough of the first local oscillator to the first intermediate frequency at the input mixer, the LO is represented as a signal at 0 Hz. To avoid the marker jumping to the LO at 0 Hz with the peak function when setting the display range, this frequency is excluded. The minimum frequency to which the marker jumps, is $\geq 6 \times$ resolution bandwidth (RBW).

deactivated No restriction to the search range. The frequency 0 Hz is included in the marker search functions.

IEC/IEEE-bus command: `CALC:MARK:LOEX ON`

Power Measurements – Hardkey MEAS

With its power measurement functions the FSP is able to measure all the necessary parameters with high accuracy in a wide dynamic range.

A modulated carrier is almost always used (except e.g. SSB-AM) for high-frequency transmission of information. Due to the information modulated upon the carrier, the latter covers a spectrum which is defined by the modulation, the transmission data rate and the signal filtering. Within a transmission band each carrier is assigned a channel taking into account these parameters. In order to ensure error-free transmission, each transmitter must be conforming to the specified parameters. These include among others:

- the output power,
- the occupied bandwidth, i.e. the bandwidth which must contain a defined percentage of the power and
- the power dissipation allowed in the adjacent channels.

Additionally the menu contains functions to determine the modulation depth of AM modulated signals and to measure the 3rd order intercept point.

The measurements and the corresponding settings are selected in the *MEAS* menu.

MEAS menu:

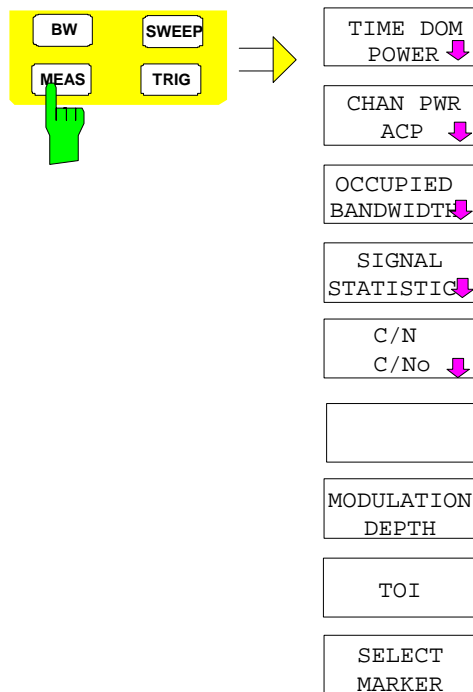

The *MEAS* key opens the menu to select and set the power measurement.

The following measurements can be selected:

- Power in the time domain (*TIME DOM POWER*)
- Channel power and adjacent-channel power in the frequency domain with a single carrier (*CHAN PWR ACP*)
- Channel power and adjacent-channel power in the frequency domain with several carriers (*MULT CARR ACP*)
- Occupied bandwidth (*OCCUPIED BANDWIDTH*)
- Carrier-to-noise ratio (*C/N, C/No*)
- Amplitude probability distribution (*SIGNAL STATISTICS*)
- Modulation depth (*MODULATION DEPTH*)
- 3rd order intercept (*TOI*)

The above measurements are carried out alternatively.

Power Measurement in Time Domain

With the aid of the power measurement function, the FSP determines the power of the signal in the time domain (SPAN = 0 Hz) by summing up the power at the individual pixels and dividing the result by the number of pixels. In this way it is possible to measure for example the power of TDMA signals during transmission or during the muting phase. Both the mean power and the rms power can be measured by means of the individual power values.

The result is displayed in the marker info field.

The measured values are updated after each sweep or averaged over a user-defined number of sweeps (AVERAGE ON/OFF and NUMBER OF SWEEPS) in order to determine e.g. the mean power over several bursts. For determination of the peak value (MAX HOLD ON) the maximum value from several sweeps is displayed.

Example:

Marker info field for: MEAN selected, AVERAGE ON and MAX HOLD ON:

```
MEAN HOLD      -2.33 dBm
MEAN AV        -2.39 dBm
```

If both the on and off phase of a burst signal are displayed, the measurement range can be limited to the transmission or to the muting phase with the aid of vertical lines. The ratio between signal and noise power of a TDMA signal for instance can be measured by using a measurement as a reference value and after that varying the measurement range.

Upon switching on power measurement the sample detector is activated (TRACE-DETECTOR-SAMPLE).

Submenu MEAS - TIME DOM POWER:

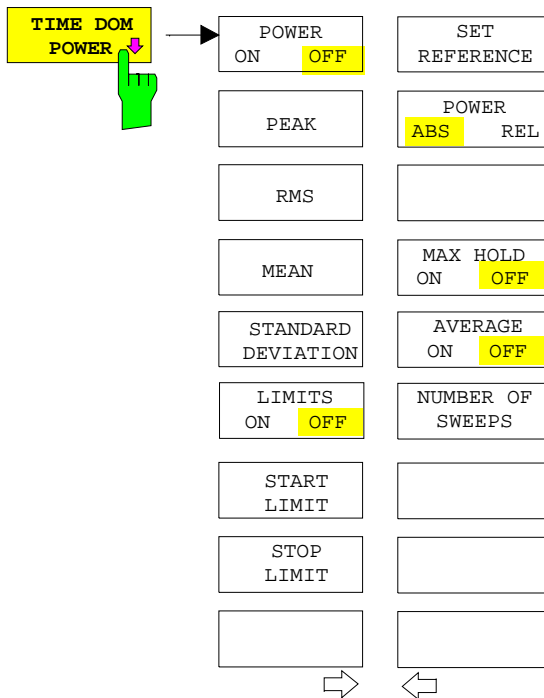

The *TIME DOM POWER* softkey activates the power measurement in the time domain and opens a submenu for configuration of the power measurement.

The submenu allows selection of the type of power measurement (rms or mean power), the settings for max hold and averaging as well as the definition of limits.

The power evaluation range can be limited by input of limit values.

Note: This softkey is only available in time domain (SPAN = 0).

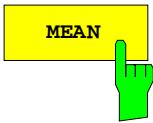

The *MEAN* softkey switches on the calculation of the mean value from the points of the displayed trace or a segment of it. The linear mean value of the equivalent voltages is calculated.

This can be used for instance to measure the mean power during a GSM burst.

For the maximum peak, the largest mean value obtained since the activation of *MAX HOLD ON* is displayed.

With *AVERAGE ON*, the mean values of a trace are averaged over several sweeps and displayed.

The number of sweeps over which the average or the maximum value is calculated is set with the *NUMBER OF SWEEPS* softkey.

IEC/IEEE-bus command: `CALC:MARK:FUNC:SUMM:MEAN ON`
 `CALC:MARK:FUNC:SUMM:MEAN:RES?`

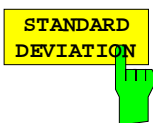

The *STANDARD DEVIATION* softkey switches on the calculation of the standard deviation of trace points from the mean value and outputs them as measured value. The measurement of the mean power is automatically switched on at the same time.

For the maximum peak, the largest standard deviation obtained since the activation of *MAX HOLD ON* is displayed.

With *AVERAGE ON*, the standard deviations of a trace are averaged over several sweeps and displayed.

The number of sweeps over which the average or the maximum value is calculated is set with the *NUMBER OF SWEEPS* softkey.

IEC/IEEE-bus command: `CALC:MARK:FUNC:SUMM:SDEV ON`
 `CALC:MARK:FUNC:SUMM:SDEV:RES?`

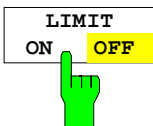

The *LIMIT ON/OFF* softkey selects the limited (*ON*) or non-limited (*OFF*) evaluation range.

The evaluation range is defined by the *START LIMIT* and *STOP LIMIT* softkeys. If *LIMIT = ON*, signals are only searched between the two lines.

If only one limit line is switched on, time line 1 is the lower limit and the upper limit corresponds to the stop frequency. If time line 2 is also switched on, it defines the upper limit.

If no limit line is switched on, the evaluation range is not limited.

The default setting is *LIMIT = OFF*.

IEC/IEEE-bus command: `CALC:MARK:X:SLIM OFF`

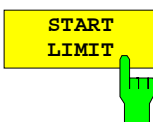

The *START LIMIT* softkey activates the entry of the lower limit of the evaluation range.

IEC/IEEE-bus command: `CALC:MARK:X:SLIM:LEFT <value>`

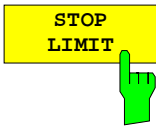

The *STOP LIMIT* softkey activates the entry of the upper limit of the evaluation range.

IEC/IEEE-bus command: `CALC:MARK:X:SLIM:RIGH <value>`

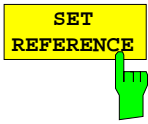

The *SET REFERENCE* softkey sets the power values currently measured as reference values for the calculation of the mean value (*MEAN*) and the rms value (*RMS*). The reference values are used to perform relative measurements.

If the calculation of the mean value (*MEAN*) and rms value (*RMS*) is not switched on, 0 dBm is used as a reference value.

If the average value (*AVERAGE*) or maximum value (*MAX HOLD*) is calculated over several sweeps, the current value is the measured value summed up at the actual time.

IEC/IEEE-bus command: `CALC:MARK:FUNC:SUMM:REF:AUTO ONCE`

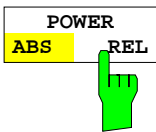

The *POWER ABS/REL* softkey selects the absolute power measurement (default setting) or relative power measurement. The reference value for the relative power is defined by *SET REFERENCE*.

The value 0 dBm is used if the reference value is not defined.

IEC/IEEE-bus command: `CALC:MARK:FUNC:SUMM:MODE ABS`

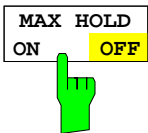

The *MAX HOLD ON/OFF* softkey switches the display of the maximum peak obtained from measurements at successive sweeps on and off.

The displayed maximum peak is only updated at the end of a sweep if a higher value has occurred.

The maximum value can be reset by switching the *MAX HOLD ON / OFF* softkey off and on again.

IEC/IEEE-bus command: `CALC:MARK:FUNC:SUMM:PHOL ON`
`CALC:MARK:FUNC:SUMM:PPE:PHOL:RES?`
`CALC:MARK:FUNC:SUMM:RMS:PHOL:RES?`
`CALC:MARK:FUNC:SUMM:MEAN:PHOL:RES?`
`CALC:MARK:FUNC:SUMM:SDEV:PHOL:RES?`

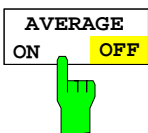

The *AVERAGE ON/OFF* softkey switches averaging over successive sweep measurements on and off.

The measured values can be reset by switching the *AVERAGE ON / OFF* softkey off and on again.

IEC/IEEE-bus command: `CALC:MARK:FUNC:SUMM:AVER ON`
`CALC:MARK:FUNC:SUMM:PPE:AVER:RES?`
`CALC:MARK:FUNC:SUMM:RMS:AVER:RES?`
`CALC:MARK:FUNC:SUMM:MEAN:AVER:RES?`
`CALC:MARK:FUNC:SUMM:SDEV:AVER:RES?`

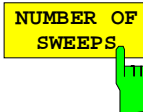

The *NUMBER OF SWEEPS* softkey activates the entry of the number of sweeps for maximum or average value calculation.

SINGLE SWEEP mode The FSP performs sweeps until the selected number of sweeps is reached and stops then.

CONTINUOUS SWEEP mode Averaging is carried out until the selected number of sweeps is reached. After that, averaging is performed in continuous mode, and is then continued as running averaging. Calculation of the maximum peak (*MAX HOLD*) is performed continuously irrespective of the selected number of sweeps.

The valid range values is 0 to 32767.

Depending on the specified number of sweeps, averaging is carried out according to the following rules:

NUMBER OF SWEEPS = 0 Continuous averaging is carried out over 10 measured values.

NUMBER OF SWEEPS = 1 No averaging is carried out.

NUMBER OF SWEEPS > 1 Averaging is carried out over the set number of measured values.

Note: *This setting is equivalent to the setting of the sweep count in the TRACE menu.*

IEC/IEEE-bus command: `SWE:COUN <value>`

Example:

The mean power of a GSM burst with 0 dBm nominal power at 800 MHz is to be measured.

[PRESET]	Set the FSP to the default setting.
[FREQ: CENTER: 800 MHz]	Set the center frequency to 800 MHz.
[SPAN: ZERO SPAN]	Select time domain display (span = 0 Hz).
[AMPT: 0 dBm]	Set the reference level to 0 dBm.
[BW: RES BW MANUAL: 30 kHz]	Set the resolution bandwidth to 30 kHz in line with the requirements of the GSM standard.
[SWEEP: SWEEPTIME MANUAL 600 µs]	Set the sweep time to 600 µs.
[TRIG: VIDEO: 50 %]	Use the video signal as trigger source.
[MEAS]	Call the menu for the measurement functions.
[TIME DOM POWER]	Select power measurement in the time domain. The FSP calculates the mean power from the points of the whole trace. The submenu for configuration of the power measurement is opened. <i>MEAN</i> is already switched on.
[LIMITS ON]	Activate the limitation of the time domain of the power measurement .
[START LIMIT: 250 µs]	Set the start of the power measurement at 250 µs.
[STOP LIMIT: 500 µs]	Set the end of the power measurement at 500 µs.

Note: *The GSM specifications require the power to be measured between 50% and 90% of the TDMA burst. The time limits set above approximately correspond to the required time domain.*

Channel and Adjacent-Channel Power Measurements

For all channel and adjacent-channel power measurements a specified channel configuration is assumed which is for instance based on a specific radiocommunication system.

This configuration is defined by the nominal channel frequency (= center frequency of the FSP if only one carrier is active), the channel bandwidth, the channel spacing, the adjacent-channel bandwidth and the adjacent-channel spacing. The FSP is able to simultaneously measure the power in up to four transmission channels and up to three adjacent channels (10 channels: 4 transmission channels, 3 lower and 3 upper adjacent channels).

It offers two methods for channel and adjacent-channel power measurement:

- The integrated bandwidth method (IBW method), i.e. the integration of trace pixels within the bandwidth of the channel to be measured to the total power of the channel,
- The measurement in time domain (Fast ACP) by means of steep resolution filters simulating the channel.

The two measurements yield the same results. The measurement in time domain can be performed much faster since the complete signal is measured within a channel at the same time. With the IBW method, the channel is divided into subspectra. This is done by means of a bandwidth which is small compared to the channel bandwidth. These subspectra are then combined by integration of the trace pixels.

With the IBW method, the transmission channels or adjacent channels are marked by vertical lines at a distance of half the channel bandwidth to the left and to the right of the corresponding channel center frequency(see Fig. 4.15-1).

With the time-domain method, the power versus time is shown for each channel. The boundaries of the channels are marked by vertical lines (see Fig. 4.15-2).

For both methods, the results are listed in tables in the lower half of the screen.

The FSP offers predefined standard settings which can be selected from a table for the common mobile radio standards. Thus, channel configuration is performed automatically without the need to enter the corresponding parameters manually.

For some standards, the channel power and the adjacent-channel power are to be weighted by means of a root-raised cosine filter corresponding to a receive filter. This type of filtering is switched on automatically for both methods on selecting the standard (e.g. NADC, TETRA or 3GPP W-CDMA).

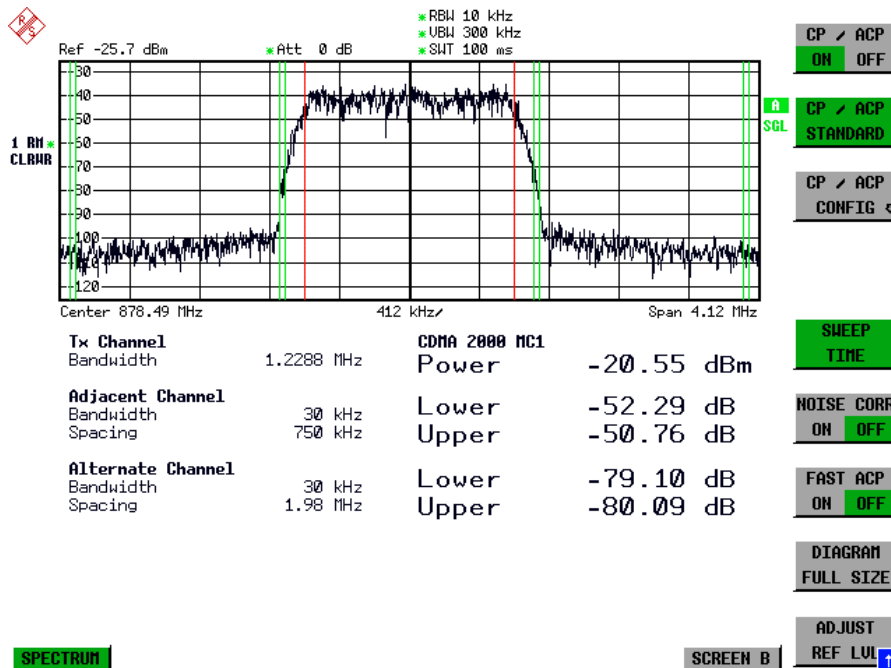

Fig. 4.15-1 Screen display of adjacent-channel power measurement using the IBW method

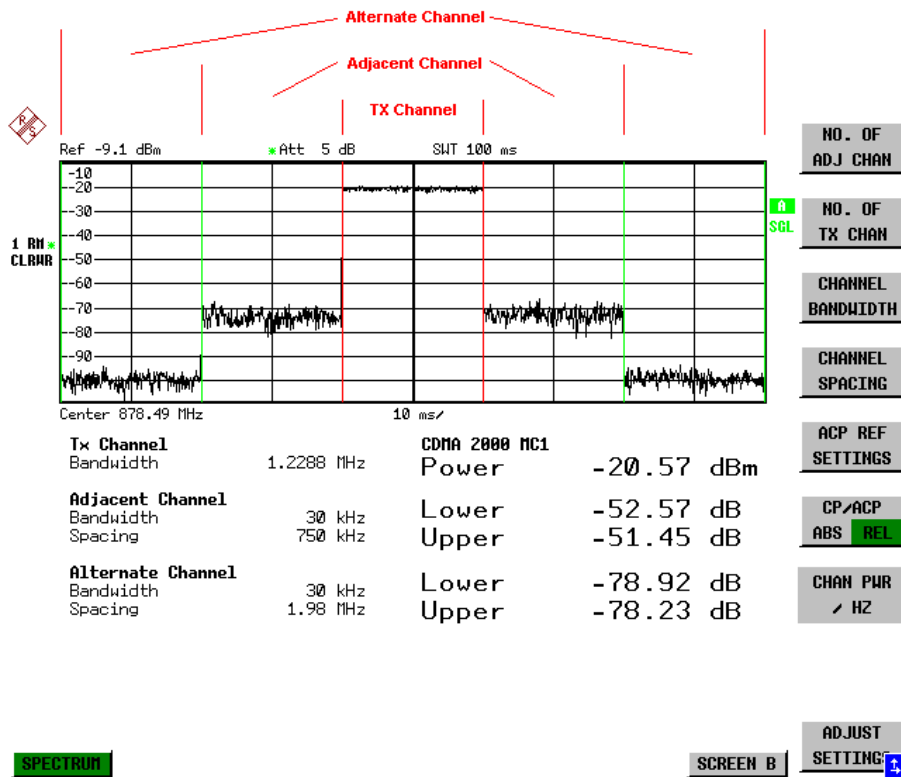
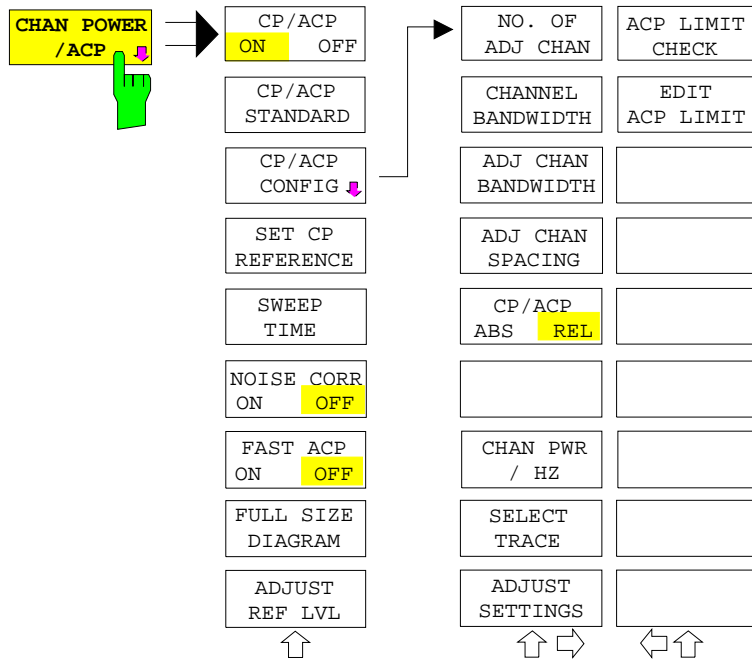

Fig. 4.15-2 Screen display of adjacent-channel power measurement using the time-domain method

Limit values for the adjacent-channel power can be defined for the measurement. If limit checking is switched on, a pass/fail information indicating that the power has been exceeded is displayed during the measurement in the table in the lower half of the screen.

Note: With the CP/ACP measurement switched on the functions SPLIT SCREEN and FULL SCREEN are inhibited.

The channel configuration is defined in the *MEAS - CHAN PWR ACP* or the *MEAS - MULT CARR ACP* menu.



The *CHAN PWR ACP* and *MULT CARR ACP* softkeys activate channel or adjacent-channel power measurement either for a single carrier signal (*CHAN PWR ACP*) or for several carrier signals (*MULT CARR ACP*), depending on the current measurement configuration. In addition, they open a submenu for defining the parameters for channel power measurement. The softkey selected is shown in colour to indicate that a channel or adjacent-channel power measurement is active.

Note: The softkeys are available only for measurements in the frequency domain (span > 0).

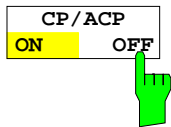

The *CP/ACP ON/OFF* softkey switches calculation of the channel power or adjacent-channel power on and off.

With default settings the measurement is performed by integrating the powers at the display points within the specified channels (IBW method).

The powers of the adjacent channels are measured either as absolute values or as relative values referenced to the power of a transmission channel. The default setting is relative-value measurement (see *CP/ACP ABS/REL* softkey).

When multicarrier ACP measurement is activated, the number of test points is increased to ensure that adjacent-channel powers are measured with adequate accuracy.

IEC/IEEE-bus commands: `CALC:MARK:FUNC:POW:SEL CPOW|ACP|MCAC`
`CALC:MARK:FUNC:POW:RES? CPOW|ACP|MCAC`
`CALC:MARK:FUNC:POW OFF`

CP/ACP
STANDARD



The *CP/ACP STANDARD* softkey opens a table for the selection of the settings according to predefined standards. The test parameters for the channel and adjacent-channel measurements are set according to the mobile radio standard.

ACP STANDARD
✓NONE
NADC IS136
TETRA
PDC
PHS
CDPD
CDMA IS95A FWD
CDMA IS95A REV
CDMA IS95C Class 0 FWD
CDMA IS95C Class 0 REV
CDMA J-STD008 FWD
CDMA J-STD008 REV
CDMA IS95C Class 1 FWD
CDMA IS95C Class 1 REV
W-CDMA 4.096 FWD
W-CDMA 4.096 REV
W-CDMA 3GPP FWD
W-CDMA 3GPP REV
CDMA 2000 DS
CDMA 2000 MC1
CDMA 2000 MC3
TD-SCDMA

The standards available are listed in the table on the left.

Note: For the FSP, the channel spacing is defined as the distance between the center frequency of the adjacent channel and the center frequency of the transmission channel. The definition of the adjacent-channel spacing in standards IS95 B and C, IS97 B and C and IS98 B and C is different. These standards define the adjacent-channel spacing from the center of the transmission channel to the closest border of the adjacent channel. This definition is also used for the FSP when the following standard settings are selected:

CDMA IS95 Class 0 FWD
 CDMA IS95 Class 0 REV
 CDMA IS95 Class 1 FWD
 CDMA IS95 Class 1 REV

The selection of the standard influences the following parameters:

- channel spacing and adjacent-channel spacing
- channel bandwidth, adjacent-channel bandwidth, and type of filtering
- resolution bandwidth
- video bandwidth
- detector
- # of adjacent channels

Trace mathematics and trace averaging are switched off.

The reference level is not influenced by the selection of a standard. To achieve an optimum dynamic range, the reference level has to be set in a way that places the signal maximum close to the reference level without forcing an overload message.

The default setting is *CP/ACP STANDARD NONE*.

IEC/IEEE-bus command: `CALC:MARK:FUNC:POW:PRES <standard>`

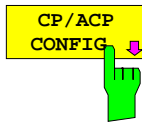

See following section "Setting the Channel Configuration"

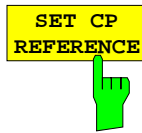

With channel power measurement activated, the *SET CP REFERENCE* softkey defines the currently measured channel power as the reference value. The reference value is displayed in the *CH PWR REF* field; the default value is 0 dBm.

In adjacent-channel power measurement with one or several carrier signals, the power is always referenced to a transmission channel, i.e. no value is displayed for *CH PWR REF*.

IEC/IEEE-bus command: `POW:ACH:REF:AUTO ONCE`

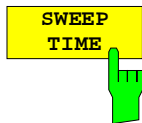

The *SWEEP TIME* softkey activates the entry of the sweep time. With the RMS detector, a longer sweep time increases the stability of the measurement results.

The function of the softkey is identical to the softkey *SWEEP TIME MANUAL* in the menu *BW*.

IEC/IEEE-bus command: `SWE:TIM <value>`

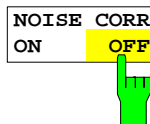

If the *NOISE CORR ON/OFF* softkey is activated, the results will be corrected by the instrument's inherent noise, which increases the dynamic range.

When the function is switched on, a reference measurement of the instrument's inherent noise is carried out. The noise power measured is then subtracted from the power in the channel that is being examined.

The inherent noise of the instrument depends on the selected center frequency, resolution bandwidth and level setting. Therefore, the correction function is disabled whenever one of these parameters is changed. A disable message is displayed on the screen.

To enable the correction function in conjunction with the changed setting, press the softkey once more. A new reference measurement is carried out.

IEC/IEEE-bus command: `SENS:POW:NCOR ON`

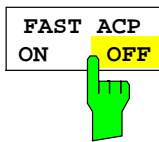

The *FAST ACP* softkey switches between the IBW method (*FAST ACP OFF*) and the time domain method (*FAST ACP ON*).

With *FAST ACP ON* the power measurement is performed in the different channels in the time domain. The FSP sets the center frequency consecutively to the different channel center frequencies and measures the power with the selected measurement time (= sweep time/number of channels). The RBW filters suitable for the selected standard and frequency offset are automatically used (e.g. root raised cos with IS 136). The list of available channel filters is included in section "Setting of Bandwidths and Sweep Time – *BW* key".

The RMS detector is used for obtaining correct power measurement results. Therefore this requires no software correction factors.

Measured values are output as a list. The powers of the transmission channels are output in dBm, the powers of the adjacent channels in dBm (*CP/ACP ABS*) or dB (*CP/ACP REL*).

The sweep time is selected depending on the desired reproducibility of results. Reproducibility increases with sweep time since power measurement is then performed over a longer time period.

As a general approach, it can be assumed that approx. 500 non-correlated measured values are required for a reproducibility of 0.5 dB (99% of the measurements are within 0.5 dB of the true measured value). This holds true for white noise. The measured values are considered as non-correlated when their time interval corresponds to the reciprocal of the measured bandwidth.

With IS 136 the measurement bandwidth is approx. 25 kHz, i.e. measured values at an interval of 40 μ s are considered as noncorrelated. A measurement time of 20 ms is thus required per channel for 1000 measured values. This is the default sweep time which the FSP sets in coupled mode. Approx. 5000 measured values are required for a reproducibility of 0.1 dB (99%), i.e. the measurement time is to be increased to 200 ms.

IEC/IEEE-bus command `SENS:POW:HSP ON`

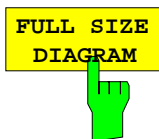

The *FULL SIZE DIAGRAM* softkey switches the diagram to full screen size.

IEC/IEEE-bus command: `DISP:WIND1:SIZE LARG|SMAL`

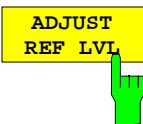

The *ADJUST REF LVL* softkey adjusts the reference level of the FSP to the measured channel power. This ensures that the settings of the RF attenuation and the reference level are optimally adjusted to the signal level without overloading the FSP or limiting the dynamic range by a too small S/N ratio.

Since the measurement bandwidth for channel power measurements is significantly lower than the signal bandwidth, the signal path may be overloaded although the trace is still significantly below the reference level.

IEC/IEEE-bus command: `SENS:POW:ACH:PRES:RLEV`

For manual setting of the test parameters different from the settings made with *ADJUST SETTINGS* the following should be observed:

Frequency span

The frequency span must at least cover the channels to be measured plus a measurement margin of 10%.

For channel power measurement, the span is 1.1 x channel bandwidth.

Note:

If the frequency span is large in comparison with the channel bandwidth (or the adjacent-channel bandwidths) being examined, only a few points on the trace are available per channel. This reduces the accuracy of the

waveform calculation for the channel filter used, which has a negative effect on the measurement accuracy.

We therefore strongly recommend that the formulas mentioned be taken into consideration when selecting the frequency span.

Resolution bandwidth (RBW)

To ensure both an acceptable measurement speed and the required selection (to suppress spectral components outside the channel to be measured, especially of the adjacent channels), the resolution bandwidth must not be selected too small or too large. As a general approach, the resolution bandwidth is to be set to values between 1% and 4% of the channel bandwidth.

A larger resolution bandwidth can be selected if the spectrum within the channel to be measured and around it has a flat characteristic. In the standard setting, e.g. for standard IS95A REV at an adjacent channel bandwidth of 30 kHz, a resolution bandwidth of 30 kHz is used. This yields correct results since the spectrum in the neighbourhood of the adjacent channels normally has a constant level. For standard NADC/IS136 this is not possible for example, since the spectrum of the transmit signal penetrates into the adjacent channels and a too large resolution bandwidth causes a too low selection of the channel filter. The adjacent-channel power would thus be measured too high.

With the exception of the IS95 CDMA standards, the *ADJUST SETTINGS* softkey sets the resolution bandwidth (RBW) as a function of the channel bandwidth:

$RBW \leq 1/40$ of channel bandwidth.

The maximum possible resolution bandwidth (with respect to the requirement $RBW \leq 1/40$) resulting from the available RBW steps (1, 3) is selected .

Video bandwidth (VBW)

For a correct power measurement, the video signal must not be limited in bandwidth. A restricted bandwidth of the logarithmic video signal would cause signal averaging and thus result in a too low indication of the power (-2.51 dB at very low video bandwidths). The video bandwidth should therefore be selected at least three times the resolution bandwidth.

The *ADJUST SETTINGS* softkey sets the video bandwidth (VBW) as a function of the channel bandwidth as follows:

$VBW \geq 3 \times RBW$.

The smallest possible VBW with regard to the available step size will be selected.

Detector

The *ADJUST SETTINGS* softkey selects the RMS detector.

The RMS detector is selected since it correctly indicates the power irrespective of the characteristics of the signal to be measured. In principle, the sample detector would be possible as well. Due to the limited number of trace pixels used to calculate the power in the channel, the sample detector would yield less stable results. Averaging, which is often performed to stabilize the measurement results, leads to a too low level indication and should therefore be avoided. The reduction in the displayed power depends on the number of averages and the signal characteristics in the channel to be measured.

Setting the Channel Configuration

MEAS - CP/ACP CONFIG submenu:

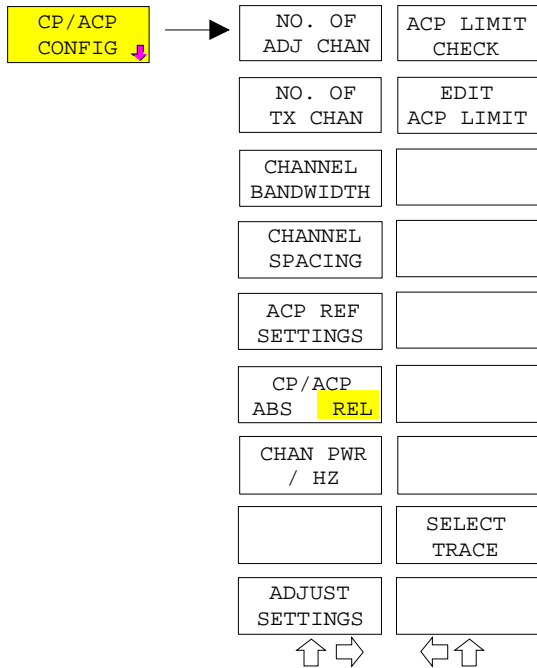

The *CP/ACP CONFIG* softkey opens a submenu for configuration of the channel power and adjacent channel power measurement independently of the offered standards.

The channel configuration includes the number of channels to be measured, the channel bandwidths (*CHANNEL BANDWIDTH*), and the channel spacings (*CHANNEL SPACING*).

Limit values can additionally be specified for the adjacent-channel power (*ACP LIMIT CHECK* and *EDIT ACP LIMITS*) which are checked for compliance during the measurement.

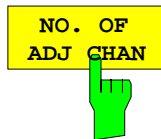

The *NO. OF ADJ CHAN* softkey activates the entry of the number $\pm n$ of adjacent channels to be considered in the adjacent-channel power measurement. Numbers from 0 to 3 can be entered.

The following measurements are performed depending on the number of the channels.

- 0 Only the channel powers are measured.
- 1 The channel powers and the power of the upper and lower adjacent channel are measured.
- 2 The channel powers, the power of the upper and lower adjacent channel and of the next higher and lower channel (alternate channel 1) are measured.
- 3 The channel power, the power of the upper and lower adjacent channel, the power of the next higher and lower channel (alternate channel 1) and of the next but one higher and lower adjacent channel (alternate channel 2) are measured.

IEC/IEEE-bus command: POW:ACH:ACP 1



The *NO. OF TX CHAN* softkey enables the entry of the number of carrier signals to be considered in channel and adjacent-channel power measurements.

Numbers from 1 to 4 can be entered.

The softkey is available only for multicarrier ACP measurements.

IEC/IEEE-bus command: SENS:POW:ACH:TXCH:COUN 4

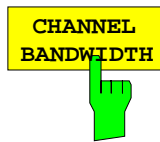

The *CHANNEL BANDWIDTH* softkey opens a table for defining the channel bandwidths for the transmission channels and the adjacent channels.

ACP CHANNEL BW	
CHAN	BANDWIDTH
ADJ	14 kHz
ALT1	14 kHz
ALT2	14 kHz

The transmission-channel bandwidth is normally defined by the transmission standard. The correct bandwidth is set automatically for the selected standard (see *CP/ACP STANDARD* softkey).

With the IBW method (*FAST ACP OFF*), the channel bandwidth limits are marked by two vertical lines right and left of the channel center frequency. It can in this way be visually checked whether the entire power of the signal under test is within the selected channel bandwidth.

Measurements in the time domain (*FAST ACP ON*) are performed in the zero span mode. The channel limits are indicated by vertical lines. For measurements requiring channel bandwidths deviating from those defined in the selected standard the IBW method is to be used.

Refer to section "Setting of Bandwidths and Sweep Time – *BW* key" for a list of available channel filters.

When measuring according to the IBW method (*FAST ACP OFF*) the bandwidths of the different adjacent channels are to be entered numerically. Since all adjacent channels often have the same bandwidth, the other channels Alt1 and Alt2 are set to the bandwidth of the adjacent channel on entering the adjacent-channel bandwidth (*ADJ*). Thus only one value needs to be entered in case of equal adjacent channel bandwidths. The same holds true for the *ALT2* channels (alternate channels 2) when the bandwidth of the *ALT1* channel (alternate channel 1) is entered.

Note: *The channel spacings can be set separately by overwriting the table from top to bottom.*

```
IEC/IEEE-bus command: SENS:POW:ACH:BWID:CHAN 14kHz
                      SENS:POW:ACH:BWID:ACH 1kHz
                      SENS:POW:ACH:BWID:ALT1 14kHz
                      SENS:POW:ACH:BWID:ALT2 14kHz
```

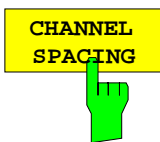

The *CHANNEL SPACING* softkey opens a table for defining the channel spacings.

ACP CHANNEL SPACING	
CHAN	SPACING
ADJ	20 kHz
ALT1	40 kHz
ALT2	60 kHz

Since all the adjacent channels often have the same distance to each other, the entry of the adjacent-channel spacing (ADJ) causes channel spacing ALT1 to be set to twice and channel spacing ALT2 to three times the adjacent-channel spacing. Thus only one value needs to be entered in case of equal channel spacing. The same holds true for the ALT2 channels when the bandwidth of the ALT1 channel is entered.

Note: *The channel spacings can be set separately by overwriting the table from top to bottom. The entry "TX" is only available for the multicarrier ACP measurement.*

IEC/IEEE-bus command: SENS:POW:ACH:SPAC:CHAN 20kHz
 SENS:POW:ACH:SPAC:ACH 20kHz
 SENS:POW:ACH:SPAC:ALT1 40kHz
 SENS:POW:ACH:SPAC:ALT2 60kHz

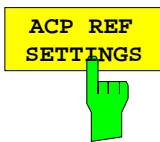

The *ACP REF SETTINGS* softkey opens a table for selecting the transmission channel to which the adjacent-channel relative power values should be referenced.

ACP REFERENCE CHANNEL	
<input checked="" type="checkbox"/>	TX CHANNEL 1
<input type="checkbox"/>	TX CHANNEL 2
<input type="checkbox"/>	TX CHANNEL 3
<input type="checkbox"/>	TX CHANNEL 4
<input type="checkbox"/>	MIN POWER TX CHANNEL
<input type="checkbox"/>	MAX POWER TX CHANNEL
<input type="checkbox"/>	LOWEST & HIGHEST CHANNEL

- TX CHANNEL 1 - 4 Selection of one of channels 1 to 4.
- MIN POWER TX CHANNEL The transmission channel with the lowest power is used as a reference channel.
- MAX POWER TX CHANNEL The transmission channel with the highest power is used as a reference channel.
- LOWEST & HIGHEST CHANNEL The outer lefthand transmission channel is the reference channel for the lower adjacent channels, the outer righthand transmission channel that for the upper adjacent channels.

Note:

The softkey is only available for the multicarrier ACP measurement.

IEC/IEEE-bus command:

```
SENS:POW:ACH:REF:TXCH:MAN 1
SENS:POW:ACH:REF:TXCH:AUTO MIN
```

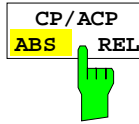

The *CP/ACP ABS/REL* softkey (channel power absolute/relative) switches between absolute and relative power measurement in the channel.

CP/ACP ABS The absolute power in the transmission channel and in the adjacent channels is displayed in the unit of the Y axis, e.g. in dBm, dBμV.

CP/ACP REL For adjacent-channel power measurements (*NO. OF ADJ CHAN > 0*), the level of the adjacent channels is displayed relative to the level of the transmission channel in dBc.

For channel power measurements (*NO. OF ADJ CHAN = 0*) with a single carrier, the power of the transmission channel is displayed relative to the power of a reference channel defined by *SET CP REFERENCE*. This means:

1. Declare the power of the currently measured channel as the reference value, using the *SET CP REFERENCE* softkey.
2. Select the channel of interest by varying the channel frequency (FSP center frequency).

With linear scaling of the Y axis, the power of the new channel relative to the reference channel (CP/CP_{ref}) is displayed. With dB scaling, the logarithmic ratio $10\lg(CP/CP_{ref})$ is displayed.

The relative channel power measurement can thus also be used for universal adjacent-channel power measurements. Each channel can be measured individually.

IEC/IEEE-bus command: `SENS:POW:ACH:MODE ABS`

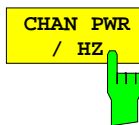

The *CHAN PWR / HZ* softkey toggles between the measurement of the total channel power and the measurement of the channel power referenced to a 1-Hz bandwidth.

The conversion factor is $10 \cdot \lg \frac{1}{\text{Channel} \cdot \text{Bandwidth}}$.

By means of this function it is possible e.g. to measure the signal/noise power density or use the additional functions *CP/ACP REL* and *SET CP REFERENCE* to obtain the signal to noise ratio.

IEC/IEEE-bus command:

```
CALC:MARK:FUNC:POW:RES:PHZ ON|OFF
```

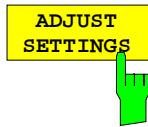

The *ADJUST SETTINGS* softkey automatically optimizes the instrument settings for the selected power measurement (see below).

All instrument settings relevant for a power measurement within a specific frequency range (channel bandwidth) are optimized for the selected channel configuration (channel bandwidth, channel spacing):

- Frequency span:

The frequency span should cover at least all channels to be considered in a measurement.

For channel power measurements, the frequency span is set as follows:

$$(\text{No. of transmission channels} - 1) \times \text{transmission channel spacing} + 2 \times \text{transmission channel bandwidth} + \text{measurement margin}$$

For adjacent-channel power measurements, the frequency span is set as a function of the number of transmission channels, the transmission channel spacing, the adjacent-channel spacing, and the bandwidth of one of adjacent-channels ADJ, ALT1 or ALT2, whichever is furthest away from the transmission channels:

$$(\text{No. of transmission channels} - 1) \times \text{transmission channel spacing} + 2 \times (\text{adjacent-channel spacing} + \text{adjacent-channel bandwidth}) + \text{measurement margin}$$

The measurement margin is approx. 10% of the value obtained by adding the channel spacing and the channel bandwidth.

- Resolution bandwidth $RBW \leq 1/40$ of channel bandwidth
- Video bandwidth $VBW \geq 3 \times RBW$
- Detector RMS detector

Trace math and trace averaging functions are switched off. The reference level is not influenced by *ADJUST SETTINGS*. It can be separately adjusted with *ADJUST REF LVL*.

The adjustment is carried out only once; if necessary, the instrument settings can be changed later.

IEC/IEEE-bus command:

```
SENS:POW:ACH:PRES ACP|CPOW|MCAC|OBW
```

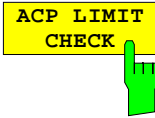

The *ACP LIMIT CHECK* softkey switches the limit check for the ACP measurement on and off.

IEC/IEEE-bus command: `CALC:LIM:ACP ON`
 `CALC:LIM:ACP:ACH:RES?`
 `CALC:LIM:ACP:ALT:RES?`

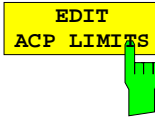

The *EDIT ACP LIMITS* softkey opens a table for defining the limits for the ACP measurement.

ACP LIMITS				
CHAN	RELATIVE LIMIT CHECK		ABSOLUTE LIMIT CHECK	
	VALUE	ON	VALUE	ON
ADJ	-45 dB	√		
ALT1	-60 dB	√		
ALT2				

The following rules apply for the limits:

- A separate limit can be defined for each adjacent channel. The limit applies to both the upper and the lower adjacent channel.
- A relative and/or absolute limit can be defined. The check of both limit values can be activated independently.
- The FSP checks adherence to the limits irrespective of whether the limits are absolute or relative or whether the measurement is carried out with absolute or relative levels. If both limits are active and if the higher of both limit values is exceeded, the measured value is marked accordingly.

Note: *Measured values exceeding the limit are marked by a preceding asterisk.*

IEC/IEEE-bus command:

```

CALC:LIM:ACP ON
CALC:LIM:ACP:ACH 0dB,0dB
CALC:LIM:ACP:ACH:STAT ON
CALC:LIM:ACP:ACH:ABS -10dBm,-10dBm
CALC:LIM:ACP:ACH:ABS:STAT ON
CALC:LIM:ACP:ALT1 0dB,0dB
CALC:LIM:ACP:ALT1:STAT ON
CALC:LIM:ACP:ALT1:ABS -10dBm,-10dBm
CALC:LIM:ACP:ALT1:ABS:STAT ON
CALC:LIM:ACP:ALT2 0dB,0dB
CALC:LIM:ACP:ALT2:STAT ON
CALC:LIM:ACP:ALT2:ABS -10dBm,-10dBm
CALC:LIM:ACP:ALT2:ABS:STAT ON
    
```

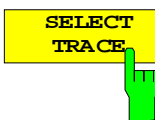

The *SELECT TRACE* softkey selects the trace on which the CP/ACP measurement is to be performed. Only activated traces can be selected, i.e. traces not set to BLANK.

IEC/IEEE-bus command: `SENS:POW:TRAC 1`

Examples:**1. Measurement of adjacent-channel power for a specific standard:**

The adjacent-channel power is to be measured for a signal at 800 MHz with 0 dBm level in line with IS136.

[PRESET]	Set the FSP to the default setting.
[FREQ: CENTER: 800 MHz]	Set the center frequency to 800 MHz.
[AMPT: 0 dBm]	Set the reference level to 0 dBm.
[MEAS]	Call the menu for the measurement functions.
[CHAN PWR / ACP]	Select the channel and adjacent-channel power measurement function. The measurement is performed with the default settings or a previously defined setting. The submenu for setting the desired new configuration is opened.
[CP/ACP STANDARD: select IS136: ENTER]	Select the NADC (IS136) standard.
[CP/ACP CONFIG]	Call the submenu for configuration of the adjacent-channel power measurement.
[NO. OF ADJ CHAN: 2 ENTER]	Select two adjacent channels for the measurement, i.e. the adjacent channel and the alternate channel are measured.
[ADJUST SETTINGS]	Set the optimum span, resolution bandwidth (RBW), video bandwidth (VBW) and detector automatically for the measurement. The absolute channel power and the relative power of the adjacent channels are displayed on the screen.
	Change to the main menu for channel power measurement.
[ADJUST REF LVL]	Set the reference level equal to the channel power measured.

2. Measurement with user-specific channel configuration:

Measurement of the adjacent-channel power ratio (ACPR) of an IS95 CDMA signal at 800 MHz, level 0 dBm. Similar to example 1, the setting can be simplified by using *CP/ACP STANDARD*.

[PRESET] Set the FSP to the default setting.

[FREQ: CENTER: 800 MHz] Set the center frequency to 800 MHz.

[AMPT: 0 dBm] Set the reference level to 0 dBm.

[MEAS] Call the menu for the measurement functions.

[CHAN PWR / ACP] Select the channel and adjacent-channel power measurement function. The measurement is carried out with the default settings or a previously defined setting. The submenu for setting the desired new configuration is opened.

[CP/ACP CONFIG] Call the submenu for defining the channel configuration.

[NO. OF ADJ CHAN:
2 ENTER]

Select two adjacent channels for the measurement, i.e. the adjacent channel and the alternate channel are measured.

[CHANNEL BANDWIDTH:

1.23 MHz: : 30 kHz]

Set the channel bandwidth to 1.23 MHz in accordance with IS 95. Set the adjacent-channel bandwidth to 30 kHz.

TX/ACP CHANNEL BW	
CHAN	BANDWIDTH
TX	1.23 MHz
ADJ	30 kHz
ALT1	30 kHz
ALT2	30 kHz

Upon entry of 30 kHz for the adjacent channel the alternate channels are also set to 30 kHz.

[CHAN SPACING:

1.25 MHz: 

885 kHz: 

-1.98 MHz] 
2.97 MHz]

Open the list for entering the channel spacings.

TX/ACP CHAN SPACING	
CHAN	SPACING
TX	1.25 MHz
ADJ	885 kHz
ALT1	1.98 MHz
ALT2	2.97 MHz

Upon entry of 885 kHz for the adjacent channel the channels ALT1 and ALT2 are set to 1770 kHz and 2655 kHz. Upon entry of 1.98 MHz for the alternate channel 1 the alternate channel 2 is set to 2.97 MHz.

[ADJUST SETTINGS]

Automatically set the optimum span (= 5 MHz), resolution bandwidth (RBW = 30 kHz), video bandwidth (VBW = 300 kHz) and detector (RMS) for the measurement. The absolute channel power and the relative power of the adjacent channels and alternate channels are displayed on the screen.

 PREV

Go to the main menu for channel power measurement.

[ADJUST REF LVL]

Set the reference level equal to the channel power measured.

3. Measurement of signal/noise power density (C/No) of an IS95 CDMA signal (frequency 800 MHz, level 0 dBm)

[PRESET]	Set the FSP to the default setting.
[FREQ: CENTER: 800 MHz]	Set the center frequency to 800 MHz.
[AMPT: 0 dBm]	Set the reference level to 0 dBm.
MEAS]	Call the menu for the measurement functions.
[CHAN PWR / ACP]	Select the channel and adjacent-channel power measurement. The measurement is performed with the default setting or a previously defined setting. The submenu for setting the desired new configuration is opened.
[CP/ACP CONFIG]	Call the submenu for defining the channel configuration.
[NO. OF ADJ CHAN: 0 ENTER]	Do not select an adjacent channel for the measurement, i.e. the measurement is carried out in one channel only.
[CHANNEL BANDWIDTH: 1.23 MHz]	Set the channel bandwidth to 1.23 MHz in line with IS95.
[ADJUST SETTINGS]	Set the optimum span (= 5 MHz), resolution bandwidth (RBW = 30 kHz), video bandwidth (VBW = 300 kHz) and detector (RMS) for the measurement automatically. The absolute channel power and the relative power of the adjacent channels and alternate channels are displayed on the screen.
	Go to the main menu for channel power measurement
[ADJUST REF LVL]	Set the reference level equal to the channel power measured.
[SET CP REFERENCE]	Set the measured channel power as a reference for the subsequent measurements.
[CP/ACP ABS / REL]	Select relative measurement related to the reference power set with SET REFERENCE (result 0 dB).
[CHAN PWR / HZ]	Select power measurement related to 1 Hz bandwidth (result -60.9 dB).
[FREQ: CENTER: 805 MHz]	Set the center frequency to 805 MHz. The FSP measures the channel power at 1.23 MHz bandwidth and outputs the result in dB relative to the reference power and 1 Hz bandwidth.

Measurement of Occupied Bandwidth

An important characteristics of a modulated signal is its occupied bandwidth. In a radio communications system for instance the occupied bandwidth must be limited to enable distortion-free transmission in adjacent channels. The occupied bandwidth is defined as the bandwidth containing a defined percentage of the total transmitted power. A percentage between 10% and 99.9% can be set on the FSP.

MEAS OCCUPIED BANDWIDTH menu:

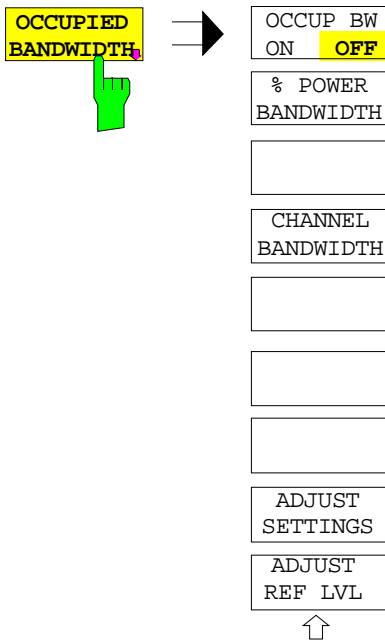

The *OCCUPIED BANDWIDTH* softkey activates measurement of the occupied bandwidth according to the current configuration and opens the submenu for configuring the measurement. The softkey is available only in frequency domain (span > 0) and is highlighted when the measurement is switched on.

In the spectrum display mode, this measurement determines the bandwidth that contains a predefined percentage of the power of the displayed frequency range (*% POWER BANDWIDTH* softkey). The occupied bandwidth is output in the marker display field and marked on the trace by temporary markers.

- Note:**
- The softkey is only available in the frequency domain (span > 0).
 - The measurement is performed on the trace with marker 1. In order to evaluate another trace, marker 1 must be placed on another trace by means of *SELECT TRACE* in the *MKR* menu

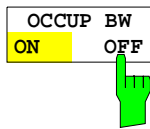

The *OCCUP BW ON/OFF* softkey switches measurement of the occupied bandwidth on or off.

IEC/IEEE-bus command: `CALC:MARK:FUNC:POW:SEL OBW`
`CALC:MARK:FUNC:POW:RES? OBW`
`CALC:MARK:FUNC:POW OFF`

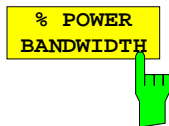

The *% POWER BANDWIDTH* softkey opens the entry of the percentage of power related to the total power in the displayed frequency range which defines the occupied bandwidth (percentage of total power). The valid range of values is 10% to 99.9%.

IEC/IEEE-bus command: `SENS:POW:BWID 99PCT`

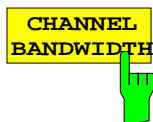

The *CHANNEL BANDWIDTH* softkey opens an input window for defining the channel bandwidth for the transmission channel. For measurements in line with a specific transmission standard, the bandwidth specified by the standard for the transmission channel must be entered.

The default setting is 14 kHz.

The specified channel bandwidth is used for optimization of the test parameters of the FSP with *ADJUST SETTINGS*.

IEC/IEEE-bus command: `SENS:POW:ACH:BWID 14kHz`

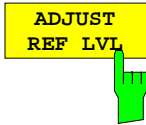

The *ADJUST REF LVL* softkey adjusts the reference level of the FSP to the measured total power of the signal. The softkey is activated after the first sweep with the measurement of the occupied bandwidth has been completed and the total power of the signal is thus known.

Adjusting the reference level ensures that the signal path of the FSP will not be overloaded and the dynamic range not limited by too low a reference level.

Since the measurement bandwidth for channel power measurements is significantly lower than the signal bandwidth, the signal path may be overloaded although the trace is distinctly below the reference level. If the measured channel power is equal to the reference level, the signal path cannot be overloaded.

IEC/IEEE-bus command: `SENS:POW:ACH:PRES:RLEV`

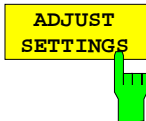

The *ADJUST SETTINGS* softkey optimizes the instrument settings for the measurement of the occupied bandwidth according to the specified channel bandwidth.

All instrument settings relevant for power measurement within a specific frequency range, such as

- frequency span 3 x channel bandwidth
- resolution bandwidth $RBW \leq 1/40$ of channel bandwidth
- video bandwidth $VBW \geq 3 \times RBW$
- detector RMS

are optimized.

The reference level is not influenced by *ADJUST SETTINGS*. For an optimum dynamic range it should be selected in a way that the signal maximum is close to the reference level.

The adjustment is carried out only once; if necessary, the instrument settings may be changed later.

IEC/IEEE-bus command: `SENS:POW:PRES:OBW`

Measurement principle:

For example, the bandwidth containing 99% of the signal power is to be determined. The routine first calculates the total power of all displayed points of the trace. In the next step, the points from the right edge of the trace are summed up until 0.5% of the total power is reached. Auxiliary marker 1 is positioned at the corresponding frequency. Then the FSP sums up the points from the left edge of the trace until 0.5% of the power is reached. Auxiliary marker 2 is positioned at this point. 99% of the power is now between the two markers. The distance between the two frequency markers is the occupied bandwidth which is displayed in the marker info field.

A prerequisite for correct measurement is that only the signal to be measured is visible on the screen of the FSP. An additional signal would invalidate the measurement.

To ensure correct power measurement especially for noise signals and to obtain the correct occupied bandwidth, the following settings should be selected:

RBW	<< occupied bandwidth (approx. 1/20 of occupied bandwidth, for voice communication type. 300 Hz or 1 kHz)
VBW	$\geq 3 \times$ RBW
Detector	RMS or sample
Span	≥ 2 to $3 \times$ occupied bandwidth

Some of the measurement specifications (e.g. PDC, RCR STD-27B) require measurement of the occupied bandwidth using a peak detector. The detector setting of the FSP has to be changed accordingly then.

Example:

Measurement of occupied bandwidth of a PDC signal at 800 MHz, level 0 dBm

[PRESET]	Set the FSP to the default setting.
[FREQ: CENTER: 800 MHz]	Set the center frequency to 800 MHz.
[AMPT: 0 dBm]	Set the reference level to 0 dBm.
[MEAS]	Call the menu for the measurement functions.
[OCCUPIED BANDWIDTH]	Select measurement of the occupied bandwidth and open the submenu for configuring the measurement.
[% POWER BANDWIDTH: 99 %]	Select 99% for the bandwidth to be measured.
[CHANNEL BANDWIDTH: 21 kHz]	Enter the channel bandwidth of 21 kHz specified by PDC.
[ADJUST SETTINGS]	Optimize the measurement parameters for the specified channel bandwidth. Allow for a complete frequency sweep so that the FSP can determine the total signal power.
[ADJUST REF LVL]	Adjust the reference level to the measured signal power.
[TRACE: DETECTOR: DETECTOR MAX PEAK]	PDC requires measurement of the occupied bandwidth using a peak detector. Therefore, switch on the peak detector instead of the RMS detector selected by ADJUST SETTINGS.

Measurement of Signal Amplitude Statistics

Digital modulated signals are similar to white noise within the transmit channel, but are different in their amplitude distribution. In order to transmit the modulated signal without distortion all amplitudes of the signal have to be transmitted linearly, e. g. from the output power amplifier. Most critical are the peak amplitude values, of course.

Degradation in transmit quality caused by a transmitter two port network is dependent on the amplitude of the peak values as well as on their probability.

The probability of amplitude values can be measured with the APD function (Amplitude Probability Distribution). During a selectable measurement time all occurring amplitude values are assigned to an amplitude range. The number of amplitude values in the specific ranges is counted and the result is displayed as a histogram. Each bar of the histogram represents the percentage of measured amplitudes within the specific amplitude range.

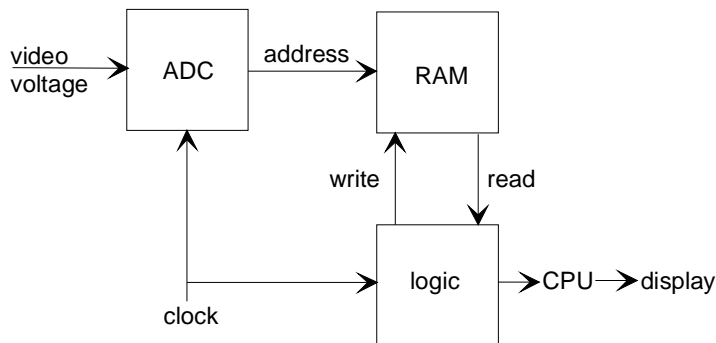

Fig. 4.15-3 Simplified block diagram for APD measurement

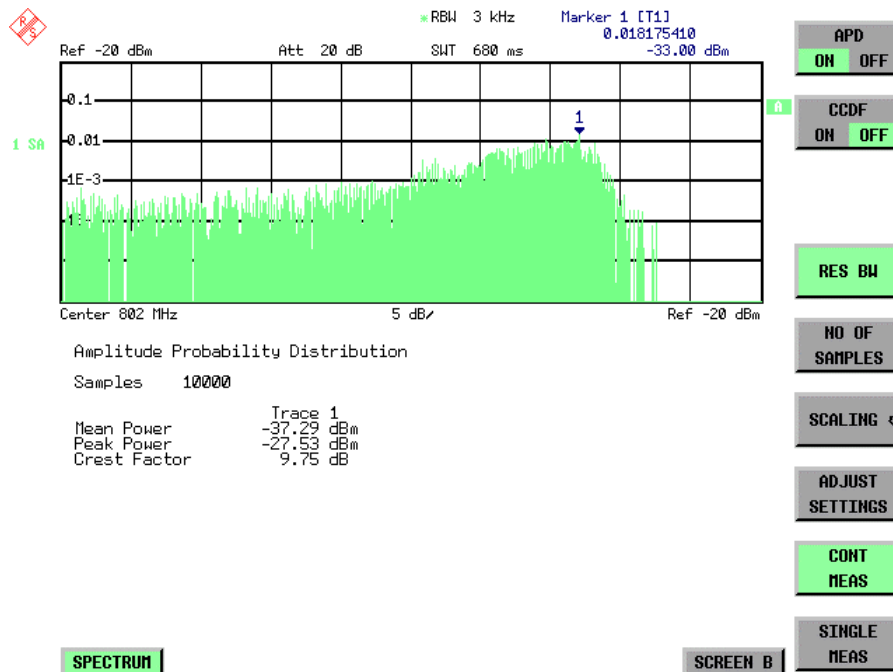

Fig. 4.15-4 Display of the amplitude probability distribution

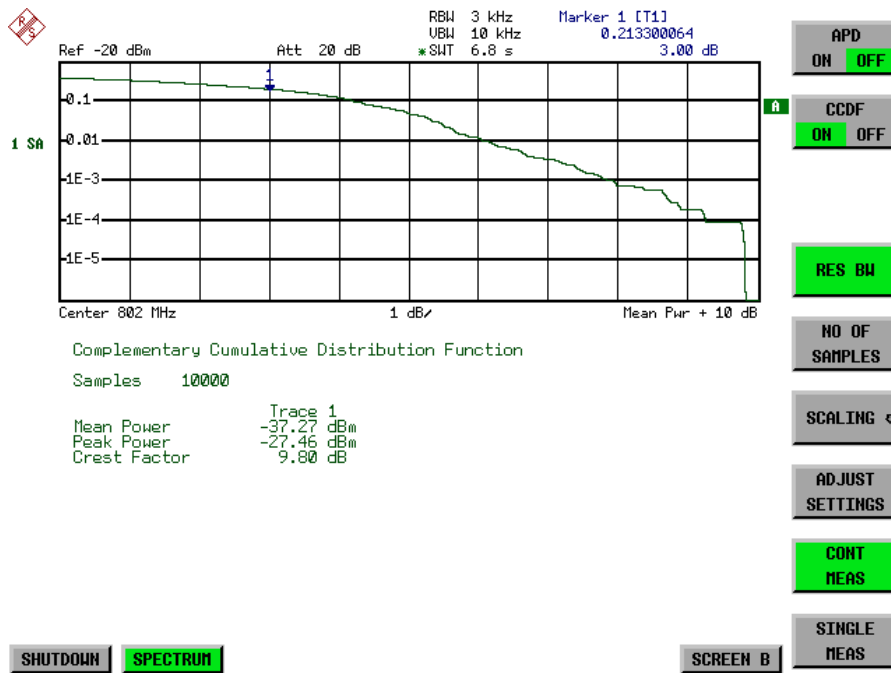

Fig. 4.15-5 Display of the complementary cumulative distribution function (CCDF)

Alternate to the histogram display of the APD the Complementary Cumulative Distribution Function (CCDF) can be displayed. It shows the probability of an amplitude exceeding a specific value. For the APD function the x-axis is scaled in absolute values in dBm, whereas for the CCDF function the x-axis is scaled relative to the MEAN POWER measured.

Definitions:

Crest factor = peak voltage to rms

CCDF = complementary cumulative distribution function

Note: During an active statistic measurement the functions FULL SCREEN, SPLIT SCREEN and selection of the active diagram via SCREEN A / SCREEN B are disabled.

MEAS SIGNAL STATISTIC submenu :

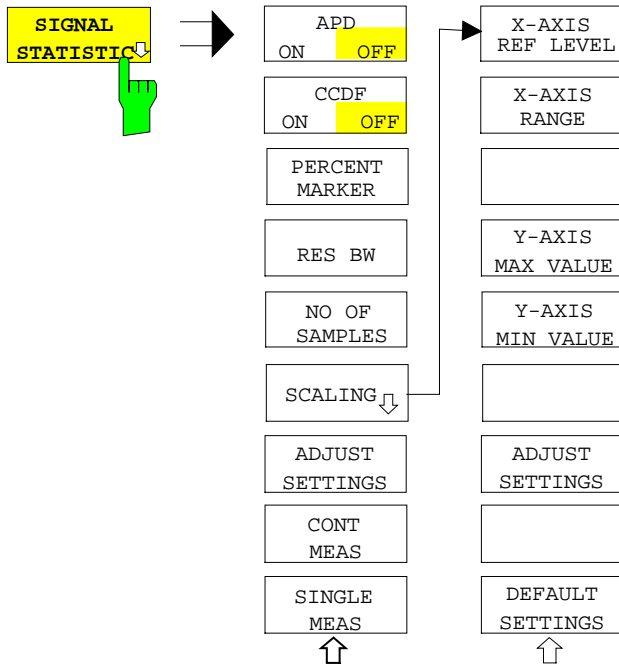

The *SIGNAL STATISTIC* softkey opens a submenu for measurement of signal statistics.

In the submenu measurement of amplitude probability density (*APD*) and complementary cumulative distribution (*CCDF*) can be selected alternately. Only one of the signal statistic functions can be switched on at a time.

In default mode all statistic functions are switched off.

With a statistic function switched on the FSP is set into zero span mode automatically.

The FSP measures the statistics of the signal applied to the RF input with the resolution bandwidth set. In order not to influence the peak amplitudes the video bandwidth is automatically set to 10 times the resolution bandwidth. The sample detector is used for detecting the video voltage.

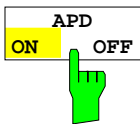

The *APD ON/OFF* softkey switches on or off the amplitude probability distribution function.

When the *APD* function is switched on, the *CCDF* function is switched off automatically.

IEC/IEEE-bus command: `CALC:STAT:APD ON`

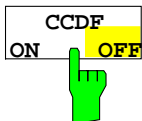

The *CCDF ON/OFF* softkey switches on or off the complementary cumulative distribution function.

When the *CCDF* function is switched on, the *APD* function is switched off automatically.

IEC/IEEE-bus command: `CALC:STAT:CCDF ON`



If the *CCDF* function is active, the *PERCENT MARKER* softkey allows to position marker 1 by entering a probability value. Thus, the power which is exceeded with a given probability can be determined very easily.

If marker 1 is in the switched-off state, it will be switched on automatically.

IEC/IEEE-bus command: `CALC:MARK:Y:PERC 0...100%`

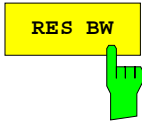

The *RES BW* softkey sets the resolution bandwidth in the menu *STATISTIC FUNCTION* directly without switching to the corresponding menu (*BW*). The function of the softkey is identical to the softkey *RES BW MANUAL* in the menu *BW*.

For correct measurement of the signal statistics the resolution bandwidth has to be wider than the signal bandwidth in order to transmit the actual peaks of the signal amplitude correctly. Video bandwidth is set to 10 MHz automatically with a statistic function switched on.

IEC/IEEE-bus command: BAND 3 MHz

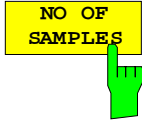

The *NO OF SAMPLES* softkey sets the number of power measurements taken into account for the statistics.

Please note that the overall measurement time is influenced by the number of samples selected as well as by the resolution bandwidth set up for the measurement as the resolution bandwidth directly influences the sampling rate.

IEC/IEEE-bus command: CALC:STAT:NSAM <value>

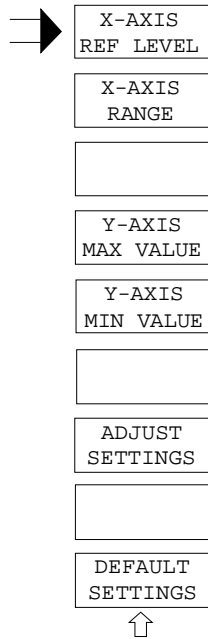
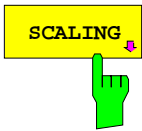

The *SCALING* softkey opens a sub menu that allows changing the scaling parameters for both the x- and the y-axis.



The *X-AXIS REF LEVEL* softkey changes the level settings of the instrument and sets the maximum power to be measured.

The function is identical to softkey *REF LEVEL* in menu *AMPT*. For the *APD* function this value is mapped to the right diagram border. For the *CCDF* function there is no direct representation of this value on the diagram as the x-axis is scaled relatively to the *MEAN POWER* measured.

IEC/IEEE command: CALC:STAT:SCAL:X:RLEV <value>



X-AXIS
RANGE

The *X-AXIS RANGE* softkey changes the level range to be covered by the statistics measurement selected. The function is identical to softkey *RANGE LOG MANUAL* in menu *AMPT*.

IEC/IEEE command: `CALC:STAT:SCAL:X:RANG <value>`

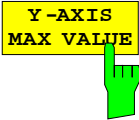

Y-AXIS
MAX VALUE

The *Y-AXIS MAX VALUE* softkey defines the upper limit of the displayed probability range. Values on the y-axis are normalized which means that the maximum value is 1.0. As the y-axis scaling has a logarithmic axis the distance between max and min value must be at least one decade.

IEC/IEEE command: `CALC:STAT:SCAL:Y:UPP <value>`



Y-AXIS
MIN VALUE

The *Y-AXIS MIN VALUE* softkey defines the lower limit of the displayed probability range. As the y-axis scaling has a logarithmic axis the distance between max and min value must be at least one decade. Valid values are in the range $0 < \text{value} < 1$.

IEC/IEEE command: `CALC:STAT:SCAL:Y:LOW <value>`

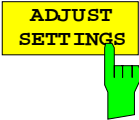

ADJUST
SETTINGS

see below

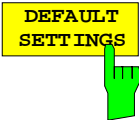

DEFAULT
SETTINGS

The *DEFAULT SETTINGS* softkey resets the x- and y-axis scalings to their PRESET values.

x-axis ref level: -20 dBm
x-axis range APD: 100 dB
x-axis range CCDF: 20 dB

y-axis upper limit: 1.0
y-axis lower limit: 1E-6

IEC/IEEE-bus command: `CALC:STAT:PRES`

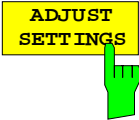

ADJUST
SETTINGS

The *ADJUST SETTINGS* softkey optimizes the level settings of the FSP according to the measured peak power in order to gain maximum sensitivity of the instrument.

The level range is adjusted according to the measured difference between peak and minimum power for APD measurement and peak and mean power for CCDF measurement in order to obtain maximum power resolution. Additionally the probability scale is adapted to the selected number of samples.

IEC/IEEE-bus command: `CALC:STAT:SCAL:AUTO ONCE`

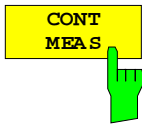

The *CONT MEAS* softkey starts collecting a new sequence of sample data and calculating the APD or CCDF curve depending on the selected measurement. The next measurement is started automatically as soon as the indicated number of samples has been reached ("CONTInuous MEASUrement").

IEC/IEEE-bus command: INIT:CONT ON ;
 INIT:IMM

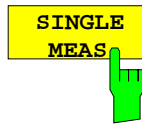

The *SINGLE MEAS* softkey starts collecting a new sequence of sample data and calculating the APD or CCDF curve depending on the selected measurement. At the beginning of the measurement previously obtained measurement results are discarded.

IEC/IEEE-bus command: INIT:CONT OFF ;
 INIT:IMM

Hint for usage of the marker functions with measurement of signal statistics:

With the signal statistic measurement level always is displayed on x-axis. Y-axis always is a normalized value between 0 and 1. In contrary to use of marker in frequency or time domain marker is input in level values and the output is in percentage values.

Example:

Measurement of CCDF of a IS95 BTS signal, level 0 dBm, frequency 800 MHz

[PRESET]	Switch on preset settings.
[FREQ: CENTER: 800 MHz]	Set center frequency to 800 MHz.
[AMPT: 10 dBm]	Set reference level to 10 dBm.
[BW: 3 MHz]	Set resolution bandwidth to 3 MHz (resolution bandwidth shall be wider than signal bandwidth (1.25 MHz) in order to have the complete signal within the resolution bandwidth).
[MEAS]	Call the menu for measurement functions.
[SIGNAL STATISTIC]	Call the menu for signal statistics measurement.
[CCDF ON/OFF]	Switch on measurement of the complementary cumulative distribution function. The FSP switches to zero span mode. The power of the signal and the CCDF is calculated for the number of samples selected. With the CCDF function sample detector and video bandwidth are set automatically.
[NO OF SAMPLES: 10000]	Set the number of measurement samples to 10000.
[SINGLE MEAS]	Start the measurement sequence. At the end the resulting trace will display the CCDF for the measured 10000 samples.

Measurement of Carrier/Noise Ratio C/N and C/N₀

Using the carrier/noise measurement function, the FSP determines the C/N ratio which can also be shown normalized to a 1 Hz bandwidth (function C/N₀).

To determine the noise power, a channel at the set center frequency is examined. The bandwidth of the channel is fixed by means of the CHANNEL BANDWIDTH function.

The largest signal in the frequency span is the carrier. It is searched when the function is activated and is marked by means of the REFERENCE FIXED marker. The noise power of the channel is subtracted from the signal level obtained (C/N), and in the case of a C/N₀ measurement it is referred to a 1 Hz bandwidth.

There are two methods for measuring the carrier/noise ratio:

1. The carrier is outside the channel examined:

In this case, it is sufficient to switch on the desired measurement function and to set the channel bandwidth. The carrier/noise ratio is displayed on the screen.

2. The carrier is inside the channel examined:

In this case, the measurement must be performed in two steps. First, the reference measurement is performed with the carrier being active. This is done by switching on either the C/N or the C/N₀ measurement and waiting for the end of the next measurement run. Then, the carrier is switched off so that only the noise of the test setup is active in the channel. The carrier/noise ratio is displayed after the subsequent measurement has been completed.

The ADJUST SETTINGS function facilitates the selection of the frequency span appropriate for the channel bandwidth: it automatically sets the SPAN to approx. 4 x channel bandwidth.

The RMS detector is enabled when the power measurement is switched on (TRACE-DETECTOR-RMS).

Submenu MEAS – C/N, C/N₀:

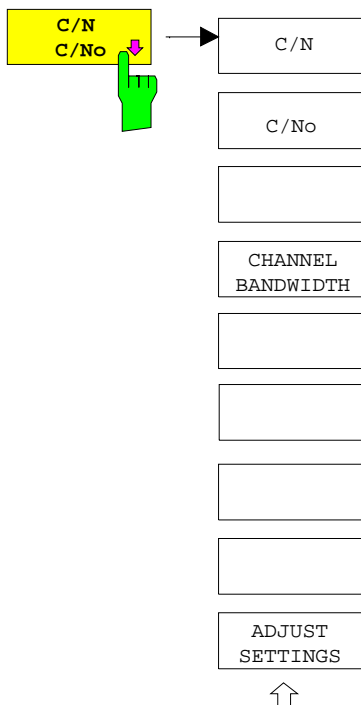

The C/N, C/No softkey opens the submenu for configuring the carrier/noise ratio measurement.

The user can choose between measurement without (C/N) and measurement with reference to the bandwidth (C/No). In addition, it is possible to select the bandwidth of the channel and to adapt the span.

Note:

The measurements are only available in the frequency domain (span >0).

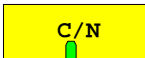
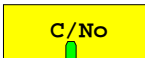
The *C/N* and *C/No* softkeys enable and disable the measurement of the carrier/noise ratio, the *C/No* measurement also being referred to a 1 Hz bandwidth.

The maximum value of the current trace is determined when the function is activated and is marked by means of the *REFERENCE FIXED* marker.

Note: *The measurement is performed on the trace where MARKER 1 is located. To measure another trace, MARKER 1 has to be shifted to the trace in question using the SELECT TRACE softkey in the MKR menu.*

If no marker is active, MARKER 1 is activated when the function is switched on.

IEC/IEEE-bus command: `CALC:MARK:FUNC:POW:SEL CN`
`CALC:MARK:FUNC:POW:RES? CN`
`CALC:MARK:FUNC:POW:SEL CNO`
`CALC:MARK:FUNC:POW:RES? CNO`
`CALC:MARK:FUNC:POW OFF`



The *CHANNEL BANDWIDTH* softkey opens a window for selecting the measurement channel bandwidth.

The default setting is 14 kHz.

The specified channel bandwidth allows the optimal setting of the measurement parameters of the FSP using *ADJUST SETTINGS*.

IEC/IEEE-bus command: `SENS:POW:ACH:BWID 14kHz`

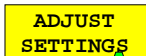

The *ADJUST SETTINGS* softkey adapts the span to the channel bandwidth selected.

For the carrier/noise ratio measurement, the span is set to:

4 x channel bandwidth + measurement margin

The adjustment is performed once; if necessary, the setting can be changed later on.

IEC/IEEE-bus command: `SENS:POW:ACH:PRES CN | CNO`

Measurement of the AM Modulation Depth

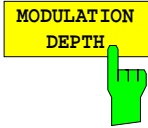

The *MODULATION DEPTH* softkey switches on the measurement of the AM modulation depth. An AM-modulated carrier is required on the screen for ensuring correct operation.

The level value of *MARKER 1* is taken as the carrier level. When this function is activated, *MARKER 2* and *MARKER 3* are automatically set symmetrically to the carrier on the adjacent peak values of the trace as delta markers and *MARKER 2* is activated for the entry.

When the position of *MARKER 2* (delta) is changed, *MARKER 3* (delta) is moved symmetrically with respect to the reference marker (*MARKER 1*).

If the data entry is activated for *MARKER 3* (*MARKER 1 2 3 4* softkey), the latter can be moved for fine adjustment irrespective of *MARKER 2*.

The FSP calculates the power at the marker positions from the measured levels. The AM modulation depth is calculated from the ratio between the power values at the reference marker and at the delta markers. When the powers of the two AM side bands are unequal, the mean value of the two power values is used for AM modulation depth calculation.

Measurement example:

The AM modulation depth of a carrier modulated with 1 kHz is to be measured at 100 MHz.

[PRESET]	The FSP is set to the default setting.
[CENTER: 100 MHz]	The center frequency is set to 100 MHz.
[SPAN: 5 kHz]	The span is set to 5 kHz.
[AMPT: 0 dBm]	The reference level is set to 0 dBm.
[MKR FCTN]	<i>MARKER 1</i> is switched on and positioned at the maximum of the displayed trace.
[<i>MODULATION DEPTH</i> : 1 kHz]	The measurement of the AM modulation depth is switched on. <i>MARKERS 2</i> and <i>3</i> (delta markers) are set to the adjacent peak values of the trace and are activated for the frequency entry. The AM modulation depth is output in % in the marker info field. When 1 kHz is entered, <i>MARKER 2</i> can be exactly positioned on 1 kHz and <i>MARKER 3</i> at -1 kHz from the reference marker.

IEC/IEEE-bus command: `CALC:MARK:FUNC:MDEP ON;`
 `CALC:MARK:FUNC:MDEP:RES?`

Measurement of the Third Order Intercept (TOI)

If several signals are applied to a transmission twoport device with nonlinear characteristic, intermodulation products appear at its output by the sums and differences of the signals. The nonlinear characteristic produces harmonics of the useful signals which intermodulate at the characteristic. The intermodulation products of lower order have a special effect since their level is largest and they are near the useful signals. The intermodulation product of third order causes the highest interference. It is the intermodulation product generated from one of the useful signals and the 2nd harmonic of the second useful signal in case of two-tone modulation.

The frequencies of the intermodulation products are above and below the useful signals. Fig. 4.15-6 shows intermodulation products P_{I1} and P_{I2} generated by the two useful signals P_{U1} and P_{U2} .

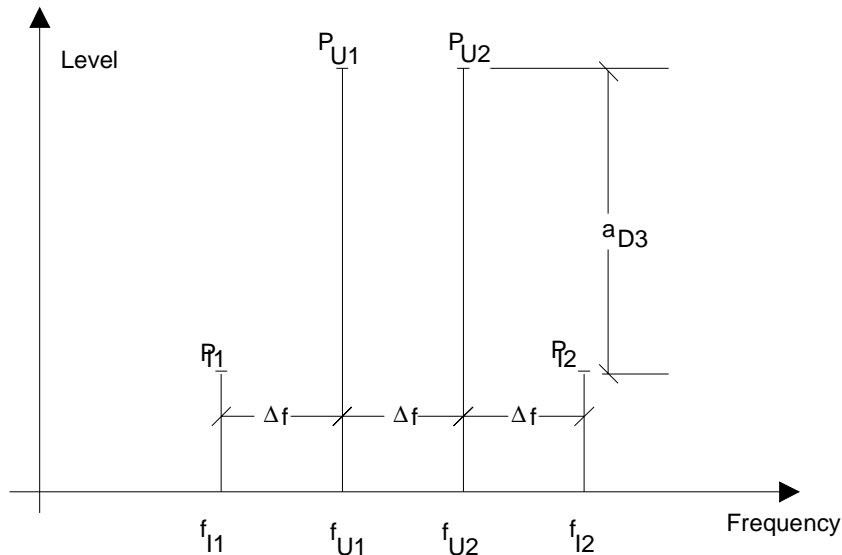

Fig. 4.15-6 Intermodulation products P_{U1} and P_{U2}

The intermodulation product at f_{I2} is generated by mixing the 2nd harmonic of useful signal P_{U2} and signal P_{U1} , the intermodulation product at f_{I1} by mixing the 2nd harmonic of useful signal P_{U1} and signal P_{U2} .

$$f_{I1} = 2 \times f_{U1} - f_{U2} \quad (1)$$

$$f_{I2} = 2 \times f_{U2} - f_{U1} \quad (2)$$

The level of the intermodulation products depends on the level of the useful signals. If the two useful signals are increased by 1 dB, the level of the intermodulation products increases by 3 dB, which means that spacing a_{D3} between intermodulation signals and useful signals is reduced by 2 dB. This is illustrated in Fig. 4.15-7.

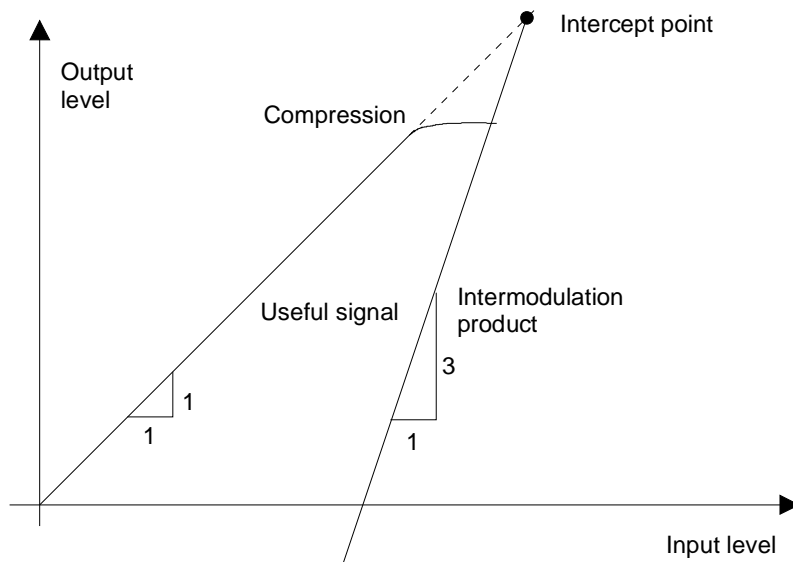

Fig. 4.15-7 Dependence of intermodulation level on useful signal level

The useful signals at the twoport output increase proportionally with the input level as long as the twoport is in the linear range. A level change of 1 dB at the input causes a level change of 1 dB at the output. Beyond a certain input level, the twoport goes into compression and the output level stops increasing. The intermodulation products of the third order increase three times as much as the useful signals. The intercept point is the fictitious level where the two lines intersect. It cannot be measured directly since the useful level is previously limited by the maximum twoport output power. It can be calculated from the known line slopes and the measured spacing a_{D3} at a given level according to the following formula.

$$IP3 = \frac{a_{D3}}{2} + P_N \quad (3)$$

The 3rd order intercept point (TOI), for example, is calculated for an intermodulation of 60 dB and an input level P_U of -20 dBm according to the following formula:

$$IP3 = \frac{60}{2} + (-20\text{dBm}) = 10\text{dBm}. \quad (4)$$

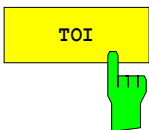

The *TOI* softkey enables the measurement of the 3rd order intercept point. A two-tone signal with equal carrier levels is expected at the FSP input. *MARKER 1* and *MARKER 2* (both normal markers) are set to the maximum of the two signals. *MARKER 3* and *MARKER 4* (both delta markers) are placed on the intermodulation products. When the function is enabled, the frequency entry is activated for the delta markers. They can be set manually. The FSP calculates the third order intercept from the level spacing between normal markers and delta markers and outputs it in the marker info field.

IEC/IEEE-bus command: `CALC:MARK:FUNC:TOI ON;`
 `CALC:MARK:FUNC:TOI:RES?`

Example:

A two-tone signal with frequencies of 100 MHz and 101 MHz is applied to the RF input of the FSP. The level of the two signals is -10 dBm.

[PRESET]	The FSP is set to the default setting.
[CENTER: 100.5 MHz]	The center frequency is set to 100.5 MHz.
[SPAN: 3 MHz]	The span is set to 3 MHz.
[AMPT: -10 dBm]	The reference level is set to -10 dBm.
[MKR FCTN]	MARKER 1 is switched on and set to the signal peak.
[TOI]	The FSP sets the 4 markers to the useful signals and the intermodulation products and calculates the third order intercept. The result is output in the marker info field.



The *SELECT MARKER* softkey activates the selection of a marker for functions *MODULATION DEPTH* and *TOI*. Thus, the markers can be fine-adjusted for these functions.

The markers are numerically selected in a data entry field. Delta marker 1 is selected by entering '0'.

If the marker is in the switch-off state, it will be switched on and can thus be shifted.

IEC/IEEE-bus command:	CALC:MARK1 ON;
	CALC:MARK1:X <value>;
	CALC:MARK1:Y?

Setup of Limit Lines and Display Lines – LINES Key

Limit lines are used to define amplitude curves or spectral distribution boundaries on the display screen which are not to be exceeded. They indicate, for example, the upper limits for interference radiation or spurious waves which are allowed from a unit under test (UUT). For transmission of information in TDMA (e.g. GSM), the amplitude of the bursts in a timeslot must adhere to a curve which must fall within a specified tolerance band. The lower and upper limits may each be specified by a limit line. Then, the amplitude curve can be controlled either visually or automatically for any violations of the upper or lower limits (GO/NOGO test).

The instrument supports limit lines with a maximum of 50 data points. 8 of the limit lines stored in the instrument can be used simultaneously and activated in the split-screen mode either in Screen A, Screen B or in the two windows. The number of limit lines stored in the instrument is only limited by the capacity of the flashdisk used.

For each limit line, the following characteristics must be defined:

- The name of the limit line. The limit line data are stored under this name and can be examined in the table *LIMIT LINES*.
- The domain in which the limit line is to be used. Here, a distinction is made between the time domain (span = 0 Hz) and the frequency domain (span > 0 Hz).
- The reference of the interpolation points to the X axis. The limit line may be specified either for absolute frequencies or times or for frequencies which are related to the set center frequency and times related to the time on the left edge of the diagram.
- The reference of the interpolation points to the Y axis. The limit line can be selected either for absolute levels or voltages or referred to the set maximum level (Ref Lvl). The position on the display depends on the *REF LEVEL POSITION*.
- With relative reference values for the Y axis, it is possible to enter an absolute threshold (THRESHOLD) which lowers the relative limit values (see below).
- The type of limit line (upper or lower limit). With this information and the active limit checking function (Table *LIMIT LINES*, *LIMIT CHECK ON*, the FSP checks for compliance with each limit.
- The limit line units to be used. The units of the limit line must be compatible with the level axis in the active measurement window.
- The measurement curve (trace) to which the limit line is assigned. For the FSP, this defines the curve to which the limit is to be applied when several traces are simultaneously displayed.
- For each limit line, a margin can be defined which serves as a threshold for automatic evaluation.
- In addition, commentary can be written for each limit line, e.g. a description of the application.

Display lines are exclusively used to optically mark relevant frequencies or points in time (span = 0) as well as constant level values. It is not possible to check automatically whether the marked level values have been underranged or exceeded.

Selection of Limit Lines

The *LINES* key opens the menu for fixing the limit lines and the display lines.

LINES menu

LINES →

SELECTED LIMIT LINE

Name: GSM900UP x-Axis: LIN
 Domain: FREQUENCY x-Scaling: ABSOLUTE
 Unit: dBm y-Scaling: ABSOLUTE
 Limit: UPPER
 Comment: GSM900 Transient Spectrum Upper Limit

LIMIT LINES				
NAME	COMPATIBLE	LIMIT CHECK	TRACE	MARGIN
√GSM900UP	√	on	1	0.000 dB
LP1GHZ	√	off	2	0.000 dB
NFSIG		off	3	0.000 dB

Center 4 GHz Span 8 GHz

SPECTRUM **SCREEN B**

Vertical menu buttons: SELECT LIMIT LINE, NEW LIMIT LINE, EDIT LIMIT LINE, COPY LIMIT LINE, DELETE LIMIT LINE, X OFFSET, Y OFFSET, DISPLAY LIMIT LINE

The *SELECTED LIMIT LINE* display field provides information concerning the characteristics of the marked limit lines.

In the *LIMIT LINES* table, the limit lines compatible to the settings of the active screen can be enabled.

New limit lines can be specified and edited in the *NEW LIMIT LINE* and *EDIT LIMIT LINE* sub-menus, respectively.

The horizontal and vertical lines of the *DISPLAY LINES* submenu mark individual levels or frequencies (span > 0) or times (span = 0) in the diagram.

The *SELECTED LIMIT LINE* table provides information about the characteristics of the marked limit line :

<i>Name</i>	name
<i>Domain</i>	frequency or time
<i>Unit</i>	vertical scale
<i>X-Axis</i>	interpolation
<i>Limit</i>	upper/lower limit
<i>X-Scaling</i>	absolute or relative frequencies/times
<i>Y-Scaling</i>	absolute or relative Y units
<i>Threshold</i>	absolute limit with relative Y units
<i>Comment</i>	commentary

The characteristics of the limit line are set in the *EDIT LIMIT LINE (=NEW LIMIT LINE)* sub-menu.



The *SELECT LIMIT LINE* softkey activates the *LIMIT LINES* table and the selection bar jumps to the uppermost name in the table.

The following information is offered in the columns of the table:

<i>Name</i>	Enable the limit line.
<i>Compatible</i>	Indicates if the limit line is compatible with the measurement window of the given trace.
<i>Limit Check</i>	Activate automatic violation check for upper/lower limits.
<i>Trace</i>	Select the measurement curve to which the limit is assigned.
<i>Margin</i>	Define margin.

Name and Compatible - Enabling limit lines

A maximum of 8 limit lines can be enabled at any one time. In split screen mode, they may be assigned to screen A, screen B or to both screens. A check mark at the left edge of a cell indicates that this limit line is enabled.

A limit line can only be enabled when it has a check mark in the *Compatible* column, i.e. only when the horizontal display (time or frequency) and vertical scales are **identical** to those of the display in the measurement window. Lines with the unit dB are compatible to all dB(..) settings of the Y axis.

If the scale of the y axis or the domain (frequency or time axis) are changed, all non-compatible limit lines are automatically switched off in order to avoid misinterpretation. The limit lines must be enabled anew when the original display is re-displayed.

IEC/IEEE-bus command: `CALC:LIM3:NAME "GSM1"`
 `CALC:LIM3:UPP:STAT ON`
 `CALC:LIM4:LOW:STAT ON`

Limit Check - Activate automatic limit violation check

When *LIMIT CHECK ON* is activated, a GO/NOGO test is performed in the active screen. In the center of the diagram, a display window appears which indicates the results of the limit check test:

LIMIT CHECK: PASSED No violations of active limits.

LIMIT CHECK: FAILED One or more active limit lines were violated. The message contains the names of the limit lines which were violated or whose margins were not complied with.

LIMIT CHECK: MARGIN The margin of at least one active limit lines was not complied with, however, no limit line was violated. The message contains the names of the limit lines whose margins were not complied with.

The following example shows two active limit lines:

```
LIMIT CHECK: FAILED
LINE VHF_MASK: Failed
LINE UHF2MASK: Margin
```

A check for violations of limit lines takes place only if the limit line of the assigned measurement curve (trace) is enabled.

If *LIM CHECK* is set to *OFF* for all active limit lines, then the limit line check is not executed and the display window is activated.

IEC/IEEE-bus command: `CALC:LIM:STAT ON`
 `INIT;*WAI`
 `CALC:LIM:FAIL?`

Trace - Select the measurement curve to which the limit line is assigned.

The selection of the measurement curve (trace) takes place in an entry window. Allowed are the integer entries 1, 2 or 3. The default setting is trace 1. If the selected limit line is not compatible with the assigned measurement curve, then the limit line is disabled (display and limit check).

IEC/IEEE-bus command: `CALC:LIM:TRAC 1`

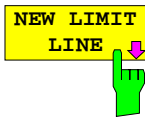

See following Section "Entry and Editing of Limit Lines".

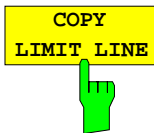
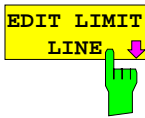

The *COPY LIMIT LINE* softkey copies the data file describing the marked limit line and saves it under a new name. In this way, a new limit line can be easily generated by parallel translation or editing of an existing limit line. The name can be arbitrarily chosen and input via an entry window (max. of 8 characters).

IEC/IEEE-bus command: `CALC:LIM3:COPY 2` or
 `CALC:LIM3:COPY "GSM2"`



The *DELETE LIMIT LINE* softkey erases the selected limit line. Before deletion, a message appears requesting confirmation.

IEC/IEEE-bus command: `CALC:LIM3:DEL`



The *X OFFSET* softkey horizontally shifts a limit line, which has been specified for relative frequencies or times (X axis). The softkey opens an entry window, where the value for shifting may be entered numerically or via the rollkey.

Note: *This softkey does not have any effect on limit lines that represent absolute values for the X axis.*

IEC/IEEE-bus command: `CALC:LIM3:CONT:OFFS 10kHz`



The *Y OFFSET* softkey vertically shifts a limit line, which has relative values for the Y axis (levels or linear units such as volt). The softkey opens an entry window where the value for shifting may be entered numerically or via the rollkey.

Note: *This softkey does not have any effect on limit lines that represent absolute values for the Y axis.*

IEC/IEEE-bus command: `CALC:LIM3:LOW:OFFS 3dB`
 `CALC:LIM3:UPP:OFFS 3dB`

Entry and Editing of Limit Lines

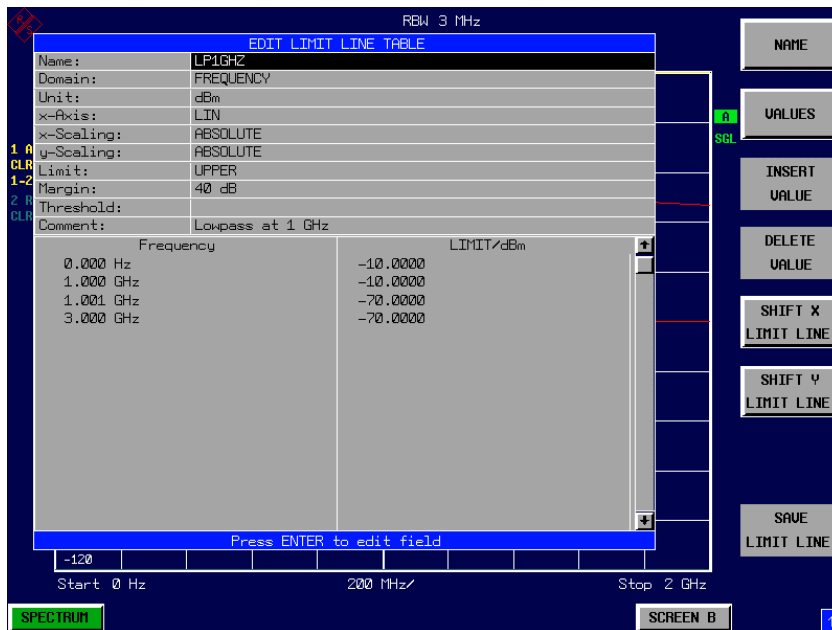

A limit line is characterized by

- its name
- the assignment of domain (frequency or time)
- the scaling in absolute or relative times or frequencies
- the vertical unit
- the interpolation
- the vertical scaling
- the vertical threshold (only with relative vertical scaling)
- the margin
- the definition of the limit line as either upper or lower limit.
- the data points for frequency/time and level

At the time of entry, the FSP immediately checks that all limit lines are in accordance with certain guidelines. These guidelines must be observed if specified operation is to be guaranteed.

- The frequencies/times for each data point must be entered in ascending order, however, for any single frequency/time, two data points may be input (vertical segment of a limit line).

The data points are allocated in order of ascending frequency/time. Gaps are not allowed. If gaps are desired, two separate limit lines must be defined and then both enabled.

- The entered frequencies/times need not necessarily be selectable in FSP. A limit line may also exceed the specified frequency or time domains. The minimum frequency for a data point is -200 GHz, the maximum frequency is 200 GHz. For the time domain representation, negative times may also be entered. The valid range is -1000 s to +1000 s.
- The minimum/maximum value for a limit line is -200 dB to +200 dB for the logarithmic or 10^{-20} to 10^{+20} or -99.9% to + 999.9% for the linear amplitude scales.

LINES - EDIT LIMIT LINE menu

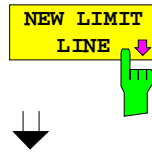
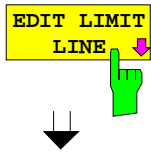

The *EDIT LIMIT LINE* and *NEW LIMIT LINE* softkeys both call the *EDIT LIMIT LINE* sub-menu used for editing limit lines. In the table heading, the characteristics of the limit line can be entered. The data points for frequency/time and level values are entered in the columns.

<i>Name</i>	Enter name.
<i>Domain</i>	Select domain.
<i>Unit</i>	Select units.
<i>X-Axis</i>	Select interpolation
<i>Limit</i>	Select upper and lower limit value.
<i>X-Scaling</i>	Entry of absolute or relative values for the X axis
<i>Y-Scaling</i>	Entry of absolute or relative values for the Y axis
<i>Margin</i>	Entry of margin.
<i>Threshold</i>	Entry of vertical threshold (only with relative vertical scaling)
<i>Comment</i>	Enter comments.
<i>Time/Frequency</i>	Enter time/frequency for the data points.
<i>Limit/dBm</i>	Enter magnitudes for the data points.

Note: *Domain, unit, X scaling and Y scaling cannot be modified as soon as reference values have been entered in the data section of the table.*

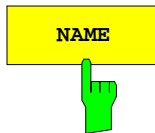

The *NAME* softkey enables the entry of characteristics in the table heading.

Name - Enter name

A maximum of 8 characters is permitted for each name. All names must be compatible with the MS DOS conventions for file names. The instrument stores all limit lines with the .LIM extension.

IEC/IEEE-bus command: `CALC:LIM3:NAME "GSM1"`

Domain - Select time or frequency domain

The default setting is frequency.

Note: *A change in domain (frequency/time) is only permitted when the data point table is empty.*

IEC/IEEE-bus command: `CALC:LIM3:CONT:DOM FREQ`

X Axis - Select interpolation

Linear or logarithmic interpolation can be carried out between the frequency reference points of the table. The ENTER key toggles between LIN and LOG selection.

IEC/IEEE-bus commands CALC:LIM3:CONT:SPAC LIN
 CALC:LIM3:UPP:SPAC LIN
 CALC:LIM3:LOW:SPAC LIN

Scaling - selection of absolute or relative scaling

The limit line can either be scaled in absolute (frequency or time) or relative units. Any of the unit keys may be used to toggle between ABSOLUTE and RELATIVE, the cursor must be positioned in the X Scaling or the Y Scaling line.

X-Scaling ABSOLUTE The frequencies or times are interpreted as absolute physical units.

X-Scaling RELATIVE In the data point table, the frequencies are referred to the currently set center frequency. In time domain mode, the left boundary of the diagram constitutes the reference.

Y-Scaling ABSOLUTE The limit values refer to absolute levels or voltages.

Y-Scaling RELATIVE The limit values refer to the reference level (Ref Level) or, in case a reference line is set, to the reference line.
 Limit values with the unit dB are always relative values.

The RELATIVE scaling is always suitable, if masks for bursts are to be defined in the time domain, or if masks for modulated signals are required in the frequency domain.

An X offset with half the sweep time may be entered in order to shift the mask in the time domain into the center of screen.

IEC/IEEE-bus command: CALC:LIM3:CONT:MODE ABS
 CALC:LIM3:UPP:MODE ABS
 CALC:LIM3:LOW:MODE ABS

Unit - Select the vertical scale units for the limit line

The selection of units takes place in a selection box. The default setting is dBm.

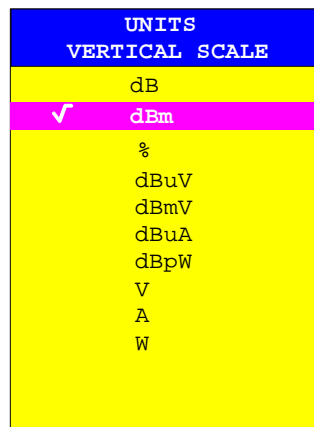

IEC/IEEE-bus command: CALC:LIM3:UNIT DBM

Limit - Select upper/lower limit

A limit line can be defined as either an upper or lower limit.

IEC/IEEE-bus command: --
(defined by key words :UPPer or :LOWer)

Margin - Setting a margin.

The margin is defined as the signal-level distance to the limit line . When the limit line is defined as an upper limit, the margin means that the level is below the limit line. When the limit line is defined as a lower limit, the margin means that the level is above the limit line. The default setting is 0 dB (i.e. no margin).

IEC/IEEE-bus command: CALC:LIM3:UPP:MARG 10dB
 CALC:LIM3:LOW:MARG 10dB

Threshold – Selection of the threshold value with relative Y scaling

With relative Y scaling, an absolute threshold value can be defined which lowers the relative limit values. The function is useful especially for mobile radio applications provided the limit values are defined in relation to the carrier power as long as they are above an absolute limit value.

Example:

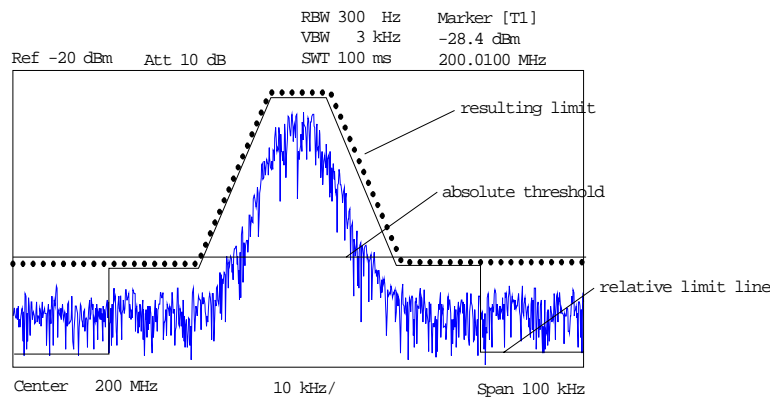

The preset value is at -200 dBm. The field is displayed if the value RELATIVE is entered in the field Y-SCALING.

IEC/IEEE-bus command: CALC:LIM3:UPP:THR -30 dBm
 OR
 CALC:LIM3:LOW:THR -30 dBm

Comment - Enter comments

Comments are arbitrary, however, they must be less than 41 characters long.

IEC/IEEE-bus command: CALC:LIM3:COMM "Upper limit"

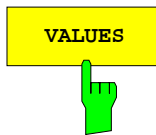

The *VALUES* softkey activates the entry of the data points in the table columns *Time/Frequency* and *Limit/dB*. Which table columns appear depends upon the *Domain* selection in the table heading.

The desired frequency/time data points are entered in ascending order (two repeated frequencies/time values are permitted).

IEC/IEEE-bus command: `CALC:LIM3:CONT:DATA 1MHz,3MHz,30MHz`
`CALC:LIM3:UPP:DATA -10,0,0`
`CALC:LIM3:LOW:DATA -30,-40,-40`

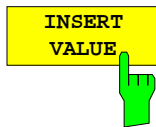

The *INSERT VALUE* softkey creates an empty line above the current cursor position where a new data point may be entered. However, during the entry of new values, it is necessary to observe an ascending order for frequency/time.

IEC/IEEE-bus command: --

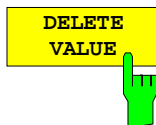

The *DELETE VALUE* softkey erases the data point (complete line) at the cursor position. All succeeding data points are shifted down accordingly.

IEC/IEEE-bus command: --

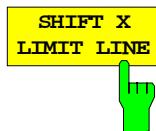

The *SHIFT X LIMIT LINE* softkey calls an entry window where the complete limit line may be shifted parallel in the horizontal direction.

The shift takes place according to the horizontal scale:

- in the frequency domain in Hz, kHz, MHz or GHz
- in the time domain in ns, μ s, ms or s

In this manner, a new limit line can be easily generated based upon an existing limit line which has been shifted horizontally and stored (*SAVE LIMIT LINE* softkey) under a new name (*NAME* softkey).

IEC/IEEE-bus command: `CALC:LIM3:CONT:SHIF 50kHz`

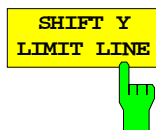

The *SHIFT Y LIMIT LINE* softkey calls an entry window where the complete limit line may be shifted parallel in the vertical direction.

The shift takes place according to the vertical scale:

- for logarithmic units, relative, in dB
- for linear units, as a factor

In this manner, a new limit line can be easily generated based upon an existing limit line which has been shifted vertically and stored (*SAVE LIMIT LINE* softkey) under a new name (*NAME* softkey).

IEC/IEEE-bus command: `CALC:LIM3:CONT:UPP:SHIF 20dB`
`CALC:LIM3:CONT:LOW:SHIF 20dB`

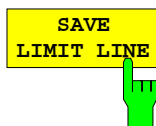

The *SAVE LIMIT LINE* softkey stores the currently edited limit line. The name can be entered in an input window (max. 8 characters)

IEC/IEEE-bus command: --

Display Lines

Display lines help to evaluate a trace – as do markers. The function of a display line is comparable to that of a ruler that can be shifted on the trace in order to mark absolute values.

The FSP provides two different types of display lines :

- two horizontal level lines for marking levels – Display Line 1/2,
- two vertical frequency or time lines for marking frequencies or points in time – Frequency/Time Line 1/2.

Each line is identified by one of the following abbreviations:

D1	Display Line 1
D2	Display Line 2
F1	Frequency Line 1
F2	Frequency Line 2
T1	Time Line 1
T2	Time Line 2

The level lines are continuous horizontal lines across the entire width of a diagram and can be shifted in y direction.

The frequency or time lines are continuous vertical lines across the entire height of the diagram and can be shifted in x direction.

The *DISPLAY LINES* submenu for activating and setting the display lines appears different depending on the display mode set in the active measurement window (frequency or time domain).

If the spectrum is shown (span \neq 0) the *TIME LINE 1* and *TIME LINE 2* softkeys are disabled, whereas in the time domain (span = 0) the *FREQUENCY LINE 1* and *FREQUENCY LINE 2* softkeys are not available.

Note: *The softkeys for setting and switching the display lines on/off work like triple switches:*

Initial situation: The line is off (softkey with gray background)

1st press: The line is switched on (softkey with red background) and the data input function is activated. The position of the display line can be selected by means of the rollkey, the step keys or a numerical entry in the appropriate field. The data input function is disabled if another function is activated. The line, however, remains switched on (softkey with green background).

2nd press: The line is switched off (softkey with gray background).

Initial situation: The line is on (softkey with green background)

1st press: The data input function is activated (softkey with red background). The position of the display line can be selected by means of the rollkey, the step keys or a numerical entry in the appropriate field. The data input function is disabled if another function is activated. The line, however, remains switched on (softkey with green background).

2nd press: The line is switched off (softkey with gray background).

LINES menu

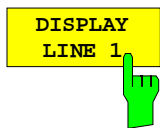
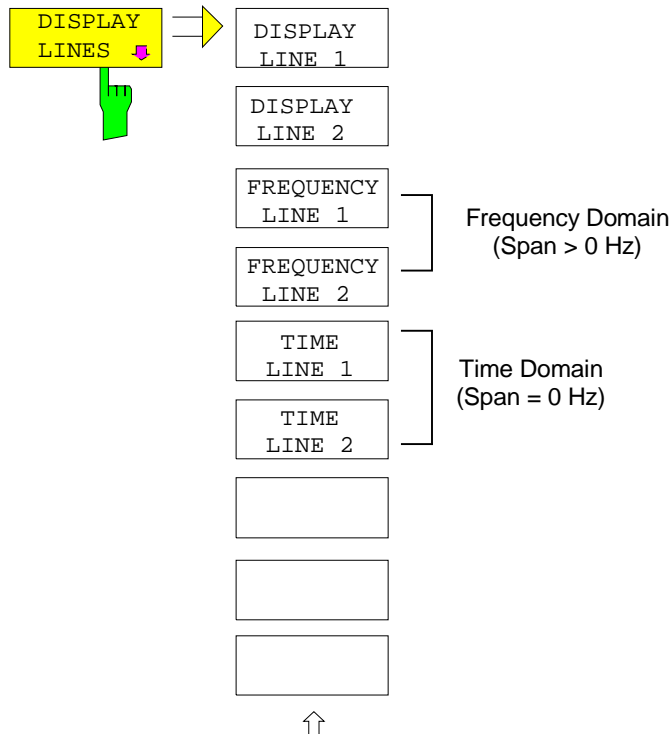

The *DISPLAY LINE 1/2* softkeys enable or disable the level lines and allow the user to enter the position of the lines.

The level lines mark the selected level in the measurement window.

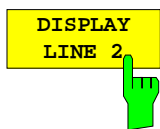

IEC/IEEE-bus command: `CALC:DLIN:STAT ON`
`CALC:DLIN -20dBm`

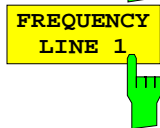

The *FREQUENCY LINE 1/2* softkeys enable or disable the frequency lines 1/2 and allow the user to enter the position of the lines.

The frequency lines mark the selected frequencies in the measurement window.

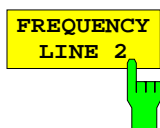

Note: *The two softkeys cannot be used in the time domain (span = 0).*

IEC/IEEE-bus command: `CALC:FLIN:STAT ON`
`CALC:FLIN 120MHz`

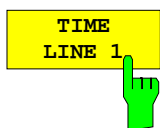

The *TIME LINE 1/2* softkeys enable or disable the time lines 1/ and allow the user to enter the position of the lines.

The time lines mark the selected times or define search ranges (see section "Marker Functions").

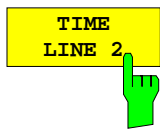

Note: *The two softkeys cannot be used in the frequency domain (span > 0).*

IEC/IEEE-bus command: `CALC:TLIN:STAT ON`
`CALC:TLIN 10ms`

Configuration of Screen Display – DISP Key

The *DISPLAY* menu allows the configuration of the diagram display on the screen and also the selection of the display elements and colors. The *POWER SAVE* mode is also configured in this menu for the display.

The test results are displayed on the screen of the FSP either in a full-screen window or in two overlapping windows. The two windows are called diagram A and diagram B.

In the default setting, the two windows are completely decoupled from each other, ie they behave like two separate instruments. This is very useful, for example with harmonics measurements or measurements on frequency-converting DUTs, since the input signal and the output signal lie in different frequency ranges.

However, specific settings of the two windows (reference level, center frequency) can be coupled, if required, so that with *CENTER B = MARKER A* for example, the shift of the marker in diagram A causes the frequency range (zoomed in some cases) to be shifted along diagram B.

New settings are performed in the diagram selected via hotkey *SCREEN A* or *SCREEN B*. If only one window is displayed, it is the diagram in which the measurements are performed; the diagram not displayed is not active for measurements.

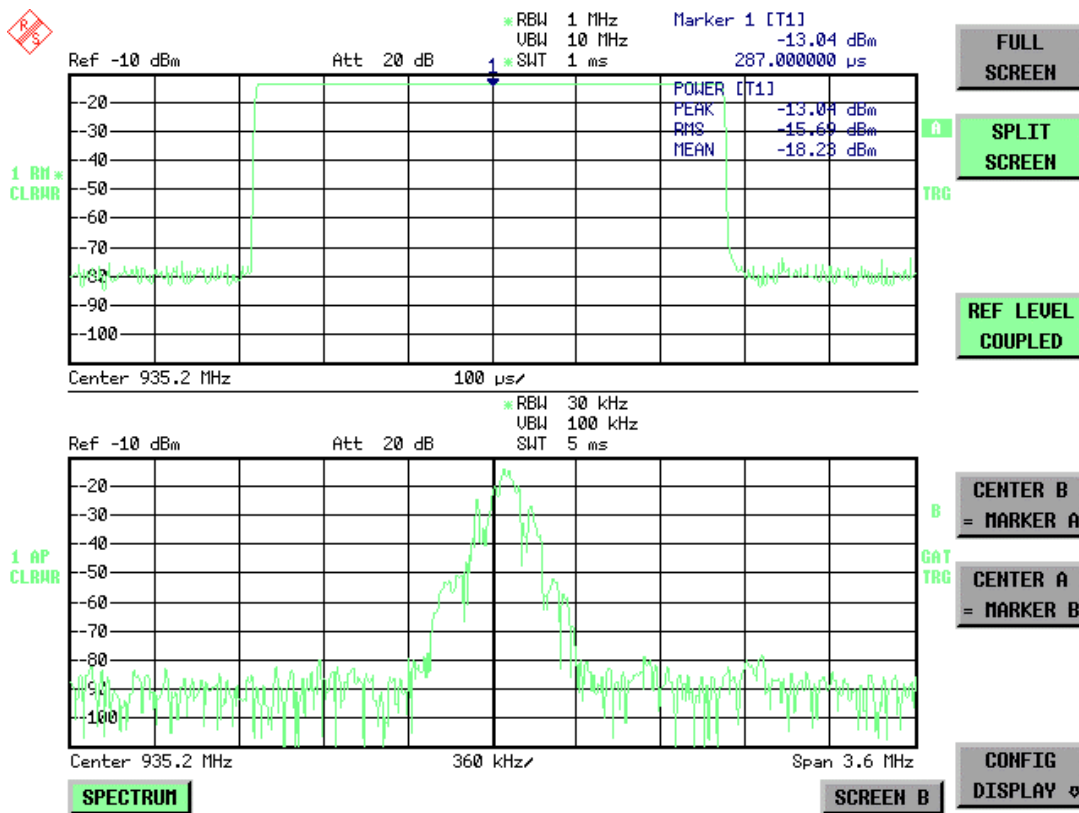
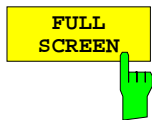
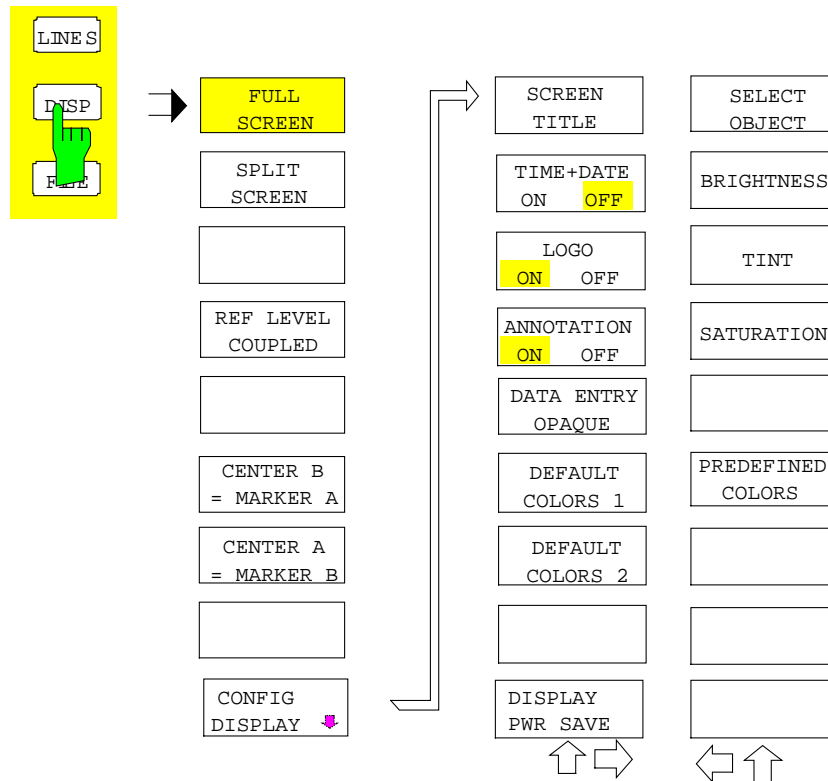

Fig. 4.17-1 Typical split-screen display, settings are uncoupled

The *DISP* key opens the menu for configuring the screen display and selecting the active diagram in SPLIT SCREEN mode.



The *FULL SCREEN* softkey selects the display of one diagram. This corresponds to the default setting of FSP.

In the *FULL SCREEN* mode it is possible to switch between two different device settings by selecting the active window (screen A or screen B). Switching between *SCREEN A* and *SCREEN B* is performed by means of the corresponding key in the *HOTKEY* bar.

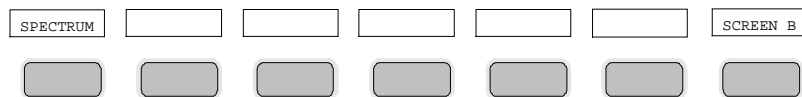

It should be noted that the measurements in the *FULL SCREEN* mode are performed only in the visible (active) window.

The active window is marked by **A** or **B** on the right of the diagram.

IEC/IEEE-bus command: `DISP:FORM SING`
`DISP:WIND<1|2>:SEL`

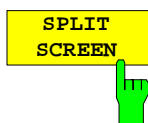

The *SPLIT SCREEN* softkey selects the display of two diagrams. The upper diagram is designated *SCREEN A*, the lower diagram *SCREEN B*.

Switching between *SCREEN A* and *SCREEN B* is performed via the corresponding key in the *HOTKEY* bar. The active window is marked by highlighting fields **A** and **B** on the right of the diagram.

IEC/IEEE-bus command: `DISP:FORM SPL`

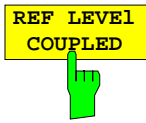

The *REF LEVEL COUPLED* softkey switches the coupling of the reference level on and off. In addition to the reference level, the mixer level and input attenuation are coupled with one another.

For the level measurement, the same reference level and input attenuation must be set for the two diagrams.

IEC/IEEE-bus command `INST:COUP RLEV`



The *CENTER B = MARKER A* and *CENTER A = MARKER B* softkeys couple the center frequency in diagram B with the frequency of marker 1 in diagram A and the center frequency in diagram B with the frequency of marker 1 in diagram B. The two softkeys are mutually exclusive.

This coupling is useful, eg for viewing the signal at the marker position in diagram A with higher frequency resolution or in the time domain in diagram B.

If marker 1 is off, it is switched on and set to the maximum of the trace in the active diagram.

IEC/IEEE-bus command: `INST:COUP CF_B`
 `INST:COUP CF_A`

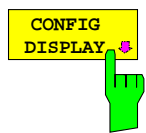

SCREEN TITLE	SELECT OBJECT
TIME+DATE ON OFF	BRIGHTNESS
LOGO ON OFF	TINT
ANNOTATION ON OFF	SATURATION
DATA ENTRY OPAQUE	
DEFAULT COLORS 1	PREDEFINED COLORS
DEFAULT COLORS 2	
DISPLAY PWR SAVE	

↑ → ← ↑

The *CONFIG DISPLAY* softkey opens a submenu allowing additional display items to be added to the screen. In addition, the display power-save mode (*DISPLAY PWR SAVE*) and the colors of the display elements can be set here.

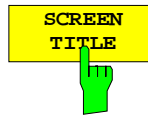

The *SCREEN TITLE* softkey activates the entry of a title for the active diagram A or B. It switches on or off a title that is already input. The length of the title is limited to max. 20 characters.

IEC/IEEE-bus command: `DISP:WIND1:TEXT 'Noise Meas'`
`DISP:WIND1:TEXT:STATE ON`

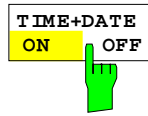

The *TIME+DATE ON/OFF* softkey switches on or off the display of date and time above the diagram.

IEC/IEEE-bus command: `DISP:TIME OFF`

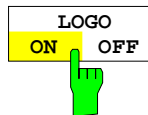

The *LOGO ON/OFF* softkey switches the Rohde & Schwarz company logo displayed in the upper left corner of the display screen on or off.

IEC/IEEE-bus command: `DISP:LOGO ON`

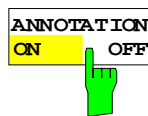

The *ANNOTATION ON/OFF* softkey switches the displaying of frequency information on the screen on and off.

ON Frequency information is displayed.

OFF Frequency information is not outputted to the display. This can be used for example to protect confidential data.

IEC/IEEE-bus command: `DISP:ANN:FREQ ON`

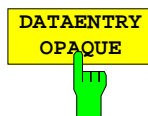

The *DATAENTRY OPAQUE* softkey sets the data entry windows to opaque. This means that entry windows are underlayed with the background color for tables.

IEC/IEEE-bus command: `--`



The *DEFAULT COLORS 1 and 2* softkey restores the default settings for brightness, color tint and color saturation for all display screen elements.

The color schemes have been selected to give optimum visibility of all picture elements at an angle of vision from above or below. *DEFAULT COLORS 1* is active in the default setting of the instrument.

IEC/IEEE-bus command: `DISP:CMAP:DEF1`
`DISP:CMAP:DEF2`





The *DISPLAY PWR SAVE* softkey is used to switch on/off the power-save mode for the display and to enter the time for the power-save function to respond. After the elapse of this time the display is completely switched off, ie including backlighting.

Note: *This mode is recommended for saving the TFT display especially when the instrument is exclusively operated in remote control.*

The power-save mode is configured as follows:

- The first keystroke activates the power-save mode and opens the editor for the response time (*POWER SAVE TIMEOUT*). The response time is entered in minutes between 1 and 6 minutes and is confirmed by *ENTER*.
- The power-save mode is deactivated by pressing the key again.

On leaving the menu with the power-save mode in the activated state, the softkey is highlighted in color on returning to the menu and opens again the editor for the response time. Pressing again the key switches off the power-save mode.

IEC/IEEE-bus command: `DISP:PSAV ON`
`DISP:PSAV:HOLD 15`

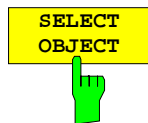

The *SELECT OBJECT* softkey activates the *SELECT DISPLAY OBJECT* table, with which a graphics element can be selected. After selection, the brightness, tint and saturation of the selected element can be changed using the softkeys of the same name. The color changes by means of the *PREDEFINED COLORS* softkey can be seen immediately on the display screen.

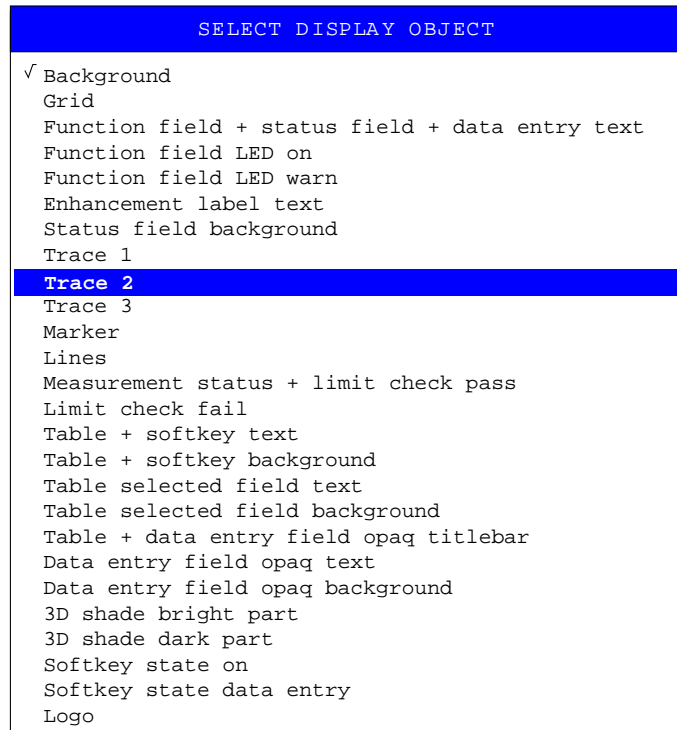



The *BRIGHTNESS* softkey activates entry of the brightness of the selected graphics element.

Values between 0 and 100% can be entered.

IEC/IEEE-bus: DISP:CMAP3:HSL < hue> , <sat> , <lum>

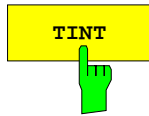

The *TINT* softkey activates the entry of the color tint of the selected element. The entered value is related to a continuous color spectrum ranging from red (0%) to blue (100%).

IEC/IEEE-bus: DISP:CMAP3:HSL <hue> , <sat> , <lum>



The *SATURATION* softkey activates the entry of the color saturation for the selected element.

The range of inputs is from 0 to 100%.

IEC/IEEE-bus: DISP:CMAP3:HSL <hue> , <sat> , <lum>



The *PREDEFINED COLORS* softkey activates a table, with which the predefined colors for the display screen elements can be selected.

COLOR
√ BLACK
BLUE
BROWN
GREEN
CYAN
RED
MAGENTA
YELLOW
WHITE
GRAY
LIGHT GRAY
LIGHT BLUE
LIGHT GREEN
LIGHT CYAN
LIGHT RED
LIGHT MAGENTA

IEC/IEEE-bus command: DISP:CMAP1 to 26:PDEF <color>

Instrument Setup and Interface Configuration – *SETUP* Key

The *SETUP* key opens the menu for configuration of the FSP:

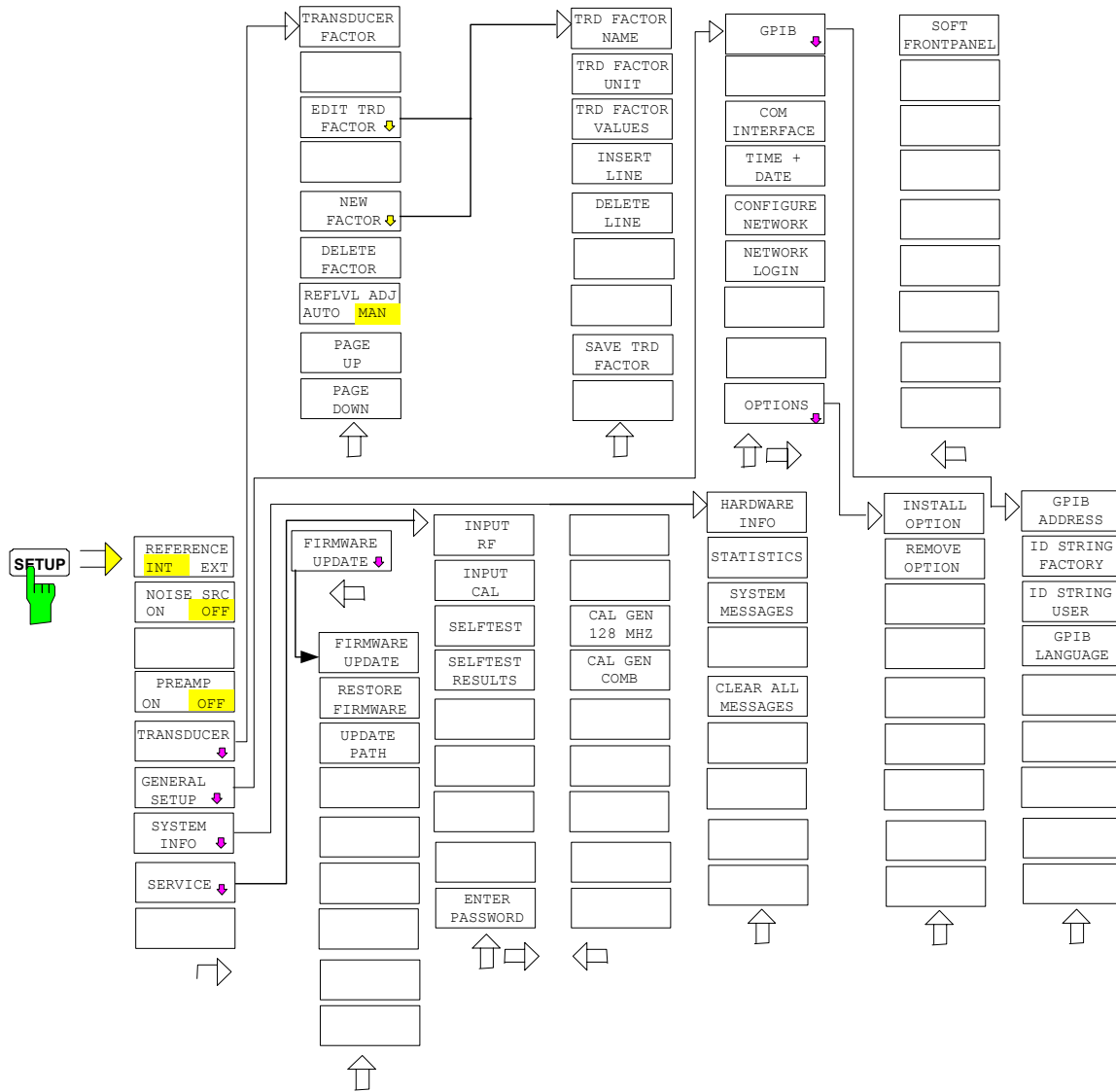

The following settings can be modified here:

- The *REFERENCE INT/EXT* softkey determines the source of the reference
- The *NOISE SRC ON/OFF* softkey switches on and off the voltage supply for an external noise source.
- The *PREAMP* softkey switches on the RF preamplifier gain. This softkey is only available with option EL. ATTENUATOR (B25).
- The *TRANSUCER* softkey opens a submenu for entering the correction characteristics for transducers.
- The *GENERAL SETUP* softkey opens a submenu for all the general settings such as IEC/IEEE-bus address, date and time as well as the configuration of the device interfaces. *FIRMWARE OPTIONS* can be installed under this menu item.

- The *SYSTEM INFO* softkey opens a submenu for displaying the hardware configuration of the instrument, the switching cycle statistics and system messages.
- The *SERVICE* softkey opens a submenu in which special device functions and system information can be selected for servicing. The password required for service functions can be entered in this submenu.
- The *SERVICE FUNCTIONS* softkey enables additional special settings for servicing and troubleshooting. It is available after entering the corresponding password under the *SERVICE* softkey.

External Reference

The FSP can use the internal reference source or an external reference source as frequency standard from which all internal oscillators are derived. A 10 MHz crystal oscillator is used as internal reference source. In the default setting (internal reference), this frequency is available as output signal at rear-panel connector REF OUT, e.g. to synchronize other instruments to the reference of the FSP. In the setting *REFERENCE EXT*, the connector REF IN is used as input connector for an external frequency standard. In this case all internal oscillators of the FSP are synchronized to the external reference frequency (also 10 MHz).

SETUP menu:

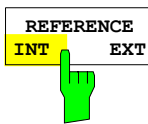

The *REFERENCE INT / EXT* softkey switches between the internal and external reference.

Note: *If the reference signal is missing when switching to external reference, the message "EXREF" appears after a while to indicate that there is no synchronization. On switching to internal reference please ensure that the external reference signal is de-activated to avoid interactions with the internal reference signal.*

IEC/IEEE-bus command: `ROSC:SOUR INT`

External Noise Source

SETUP menu:

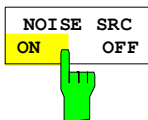

The *NOISE SRC ON/OFF* softkey switches on or off the supply voltage for an external noise source which is connected to the *NOISE SOURCE* connector on the rear panel of the instrument.

IEC/IEEE-bus command: `DIAG:SERV:NSO ON`

RF Preamp

To improve the noise figure, a low-noise preamplifier with variable gain at the RF input can be switched into the signal path.

SETUP menu:

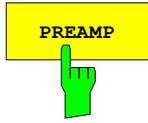

The *PREAMP* softkey switches the preamplifier on and activates the entry of the preamplifier gain. The preamplifier is switched off by pressing the softkey again.

The only possible value with option el. attenuator is 20 dB.

IEC/IEEE-bus command: `INP:GAIN 0DB`

Note: *The PREAMP softkey is only available with option EL. ATTENUATOR (FSP-B25) .*

Transducer

Activating Transducer Factors

The *TRANSDUCER* softkey opens a submenu enabling the user to activate or deactivate defined transducer factors, to generate new transducer factors or to edit existing ones. A table with the transducer factors defined is displayed.

As soon as a transducer is activated, the unit of the transducer is automatically used for all the level settings and outputs. The unit cannot be changed in the *AMPT* menu since the FSP and the transducer used are regarded as one measuring instrument. Only if the transducer has the unit dB, will the unit originally set on the FSP be maintained and can be changed.

If a transducer factor is active, the remark TDF appears in the Enhancement Labels column. After all transducers have been switched off, the FSP returns to the unit that was used before a transducer was activated.

In the analyzer mode, an active transducer for a sweep is calculated once in advance for every point displayed and is added to the result of the level measurement during the sweep. If the sweep range changes, the correction values are calculated again. If several measured values are combined, only one value is taken into consideration.

If the active transducer factor is not defined for the entire sweep range, the values missing are replaced by zeroes.

SETUP menu:

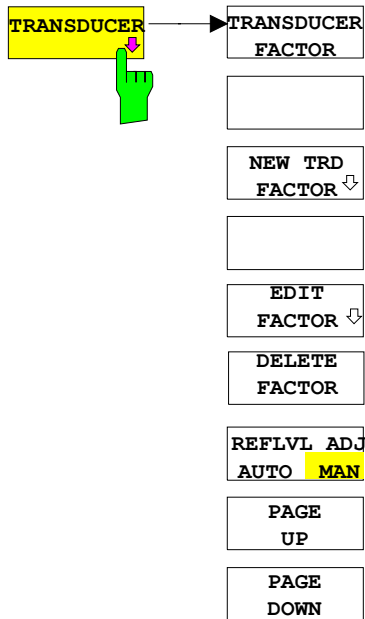

The *TRANSDUCER* softkey opens a submenu where defined transducer factors can be edited or new transducer factors can be entered. A table with the available factors is displayed, and the active transducer can be selected from this list.

TRANSDUCER FACTOR	
Name	Unit
<input checked="" type="checkbox"/> Cable_1	dB
HK116	dBuV/m
HL223	dBuV/m

The *TRANSDUCER FACTOR* table contains all the defined factors with name and unit. If the number of transducer factors defined exceeds the number of lines available in the table, the user has to scroll through the table.

Only one factor at a time can be activated. A tick next to the name indicates that the transducer is active.

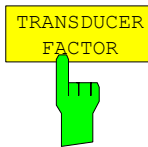

The *TRANSDUCER FACTOR* softkey places the scrollbar on the position of the active transducer factor. If a transducer factor is not active, the scrollbar is placed on the first line of the table.

IEC/IEEE-bus command: CORR:TRAN:SEL <name>
CORR:TRAN ON | OFF

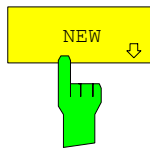

The *NEW* and *EDIT* softkeys give access to the submenu for editing and generating transducer factors.

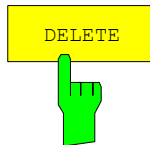
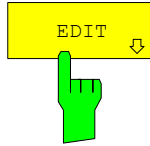

The *DELETE* softkey deletes the factor that is marked. To prevent inadvertent deleting, the instrument outputs a confirmation query.

MESSAGE	
Do you really want to delete the factor?	
YES	NO

IEC/IEEE-bus command: CORR:TRAN DEL



When a transducer factor is used, the trace is moved by a calculated shift. However, an upward shift reduces the dynamic range for the displayed values. With the softkey REFLVL ADJ an automatic reference level offset adaptation allows to restore the original dynamic range by also shifting the reference level by the maximum value of the transducer factor.

IEC/IEEE-bus command:

CORR:TRAN:ADJ:RLEV ON | OFF

Note: Command CORR:TRAN:SEL has to be sent prior to this command

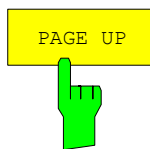

The *PAGE UP* and *PAGE DOWN* softkeys are used to scroll through large tables that cannot completely be displayed on the screen.

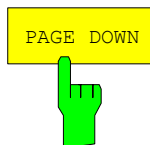

Entry and Editing of Transducer Factors

A transducer factor is characterized by the following:

- Reference values with frequency and factor (*Values*)
- Unit of the factor (*Unit*) and
- Name (*Name*) to distinguish the various factors.

During entry the FSP checks the transducer factor for compliance with specific rules that must be met to ensure correct operation.

- The frequencies for the reference values must always be entered in ascending order. Otherwise the entry will not be accepted and the following message will appear.

Frequency Sequence!

- The frequencies entered may exceed the frequency range of the FSP since only the set frequency range is taken into account for measurements. The minimum frequency of a reference value is 0 Hz, the maximum frequency 200 GHz.
- The value range for the transducer factor is ± 200 dB. If the minimum or maximum value is exceeded, the FSP outputs the following message:

Min Level -200 dB or

Max Level 200 dB.

- Gain has to be entered as a negative value, and attenuation as a positive value.

Note: *The softkeys in the "UNIT" submenu of the AMPT key cannot be operated if the transducer is on.*

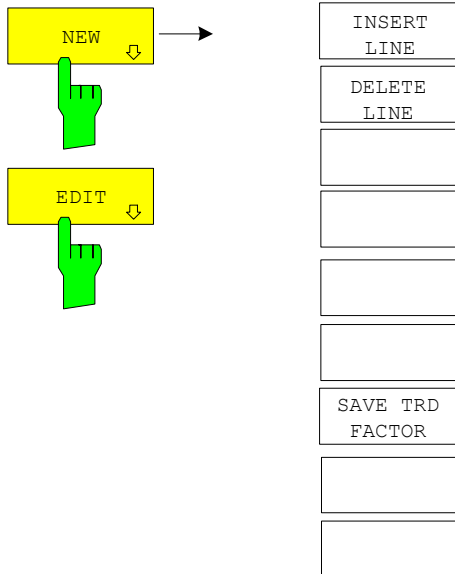

The *NEW* and *EDIT* softkeys give access to the submenu for editing and generating transducer factors.

EDIT TRANSDUCER FACTOR			
Name/Unit/Interpolation:		Cable	dB
Comment:			LIN
FREQUENCY	TDF/dB..	FREQUENCY	TDF/dB..
1.0000000 MHz	1.000		
1.0000000 GHz	5.500		

Depending on the softkey selected, either the table with the data of the factor marked (softkey *EDIT*) or an empty table (softkey *NEW*) appears. This table is empty except for the following entries:

Unit: dB
 Interpolation: LIN for linear frequency scaling
 LOG for logarithmic frequency scaling

The features of the factor are entered in the header of the table, and the frequency and the transducer factor are entered in the columns.

- Name* Entry of name
- Unit* Selection of unit
- Interpolation* Selection of interpolation
- Comment* Entry of comment
- FREQUENCY* Entry of frequency of reference values
- TDF/dB* Entry of transducer factor.

During editing, a transducer factor remains stored in the background until the factor edited is saved with the *SAVE TRD FACTOR* softkey or until the table is closed. A factor that was edited by mistake can be restored by leaving the entry function.

Name – Entry of name

The name may consist of a maximum of 8 characters that have to comply with the conventions for DOS file names. The instrument automatically adds the extension .TDF to all transducer factors that are saved.

If an existing name is changed, the factor stored under the previous name is maintained and is not automatically overwritten by the new version. The old factor can be deleted later on using the *DELETE* function. This makes it possible to copy factors.

IEC/IEEE-bus command `CORR:TRAN:SEL <name>`

Unit - Selection of unit

The unit of the transducer factor is selected from a box that is activated by pressing ENTER.

FACTOR	UNIT
	dB
	dBm
	dB μ V
	dB μ V/m
	dB μ A
	dB μ A/m
✓	dBpW
	dBpT

The default setting is dB.

IEC/IEEE-bus command `CORR:TRAN:UNIT <string>`

Interpolation - Selection of interpolation

Linear or logarithmic interpolation can be performed between the frequency reference values of the table. The ENTER key allows the user to select LIN or LOG (toggle function).

IEC/IEEE-bus command `CORR:TRAN:SCAL LIN|LOG`

The following diagrams show the effect that interpolation has on the calculated trace:

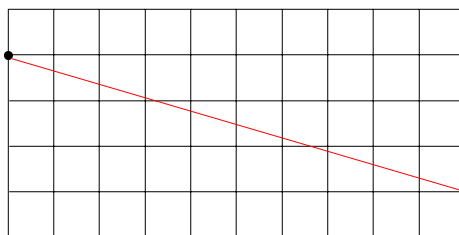

Fig. 4.18-1 Linear frequency axis and linear interpolation

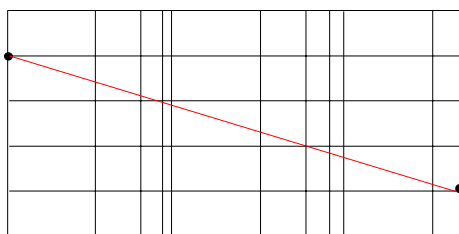

Fig. 4.18-2 Logarithmic frequency axis and interpolation

Comment - Entry of comment

Any comment with a maximum length of 50 characters can be entered.

IEC/IEEE-bus command `CORR:TRAN:COMM <string>`

FREQUENCY, TDF/dB – Entry of values

The scrollbar marks the first reference value. The desired reference values must be entered in ascending order of frequencies. After the frequency has been entered, the scrollbar automatically goes to the associated level value.

The table can be edited after entry of the first value using the *INSERT LINE* and *DELETE LINE* softkeys. To change individual values later on, the value has to be selected and a new one entered.

IEC/IEEE-bus command `CORR:TRAN:DATA <freq>,<level>`.

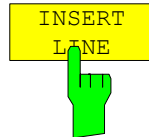

The *INSERT LINE* softkey inserts an empty line above the marked reference value. When entering a new reference value in the line, the ascending order of frequencies must be taken into consideration, however.

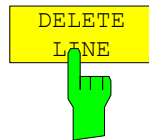

The *DELETE LINE* softkey deletes the marked reference value (complete line). The reference values that follow move one line up.

IEC/IEEE-bus command --



The *SAVE TRD FACTOR* softkey saves the changed table in a file on the internal hard disk.

If there is already a transducer factor that has the same name, a confirmation query is output.

If the new factor is active, the new values become immediately valid.

IEC/IEEE-bus command - (With IEC/IEEE bus operation, the save operation is performed automatically after the definition of the reference values)

Programming the Interface Configuration and Time Setup

The *GENERAL SETUP* softkey opens a submenu in which the general instrument parameters can be set up. In addition to the configuration of the digital interfaces (*IECBUS*, *COM*), the date and time may be entered.

The current settings are displayed in tabular form on the display screen where they may be edited.

SETUP - GENERAL SETUP submenu:

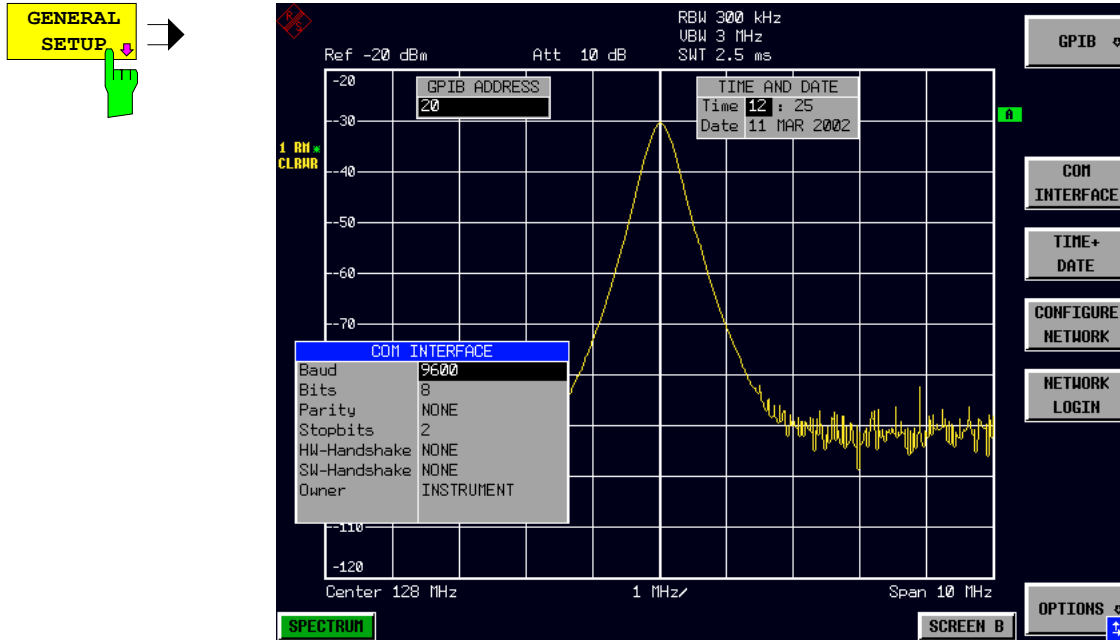

Selecting the IEC/IEEE-Bus Address

SETUP - GENERAL SETUP menu:

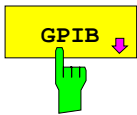

The *GPIB* softkey opens a submenu for setting the parameters of the remote-control interface.

IEC/IEEE-bus command: --



The *GPIB ADDRESS* softkey enables the entry of the IEC/IEEE-bus address.

Valid addresses are 0 through 30. The default address is 20.

IEC/IEEE-bus command: `SYST:COMM:GPIB:ADDR 20`

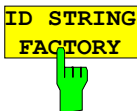

The *ID STRING FACTORY* softkey selects the default response to the *IDN? query.

IEC/IEEE-bus command: --

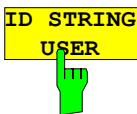

The *ID STRING USER* softkey opens an editor for entering a user-defined response to the *IDN? query.

Max. length of output string: 36 characters

IEC/IEEE-bus command: --



The *GPIB LANGUAGE* softkey opens a list of selectable remote-control languages:

- SCPI
- 8560E
- 8561E
- 8562E
- 8563E
- 8564E
- 8565E
- 8566A
- 8566B
- 8568A
- 8568B
- 8594E

Note:

For 8566A/B, 8568A/B and 8594E, command sets A and B are available. Command sets A and B differ in the rules regarding the command structure.

On switching between remote-control languages, the following settings or changes will be made:

SCPI:

- The instrument will perform a *PRESET*.

8566A/B, 8568A/B, 8594E:

- The instrument will perform a *PRESET*.
- The following instrument settings will then be changed:

Model	# of Trace Points	Start Freq.	Stop Freq.	Ref Level	Input Coupling
8566A/B	1001	2 GHz	22 GHz	0 dBm	DC (FSU/FSQ) AC (FSP)
8568A/B	1001	0 Hz	1.5 GHz	0 dBm	AC
8560E	601	0 Hz	2.9 GHz	0 dBm	AC
8561E	601	0 Hz	6.5 GHz	0 dBm	AC
8562E	601	0 Hz	13.2 GHz	0 dBm	AC
8563E	601	0 Hz	26.5 GHz	0 dBm	AC
8564E	601	0 Hz	40 GHz	0 dBm	AC
8565E	601	0 Hz	50 GHz	0 dBm	AC
8594E	401	0 Hz	3 GHz	0 dBm	AC

- Switchover of the "# of Trace Points" will not take place until the instrument is switched to the *REMOTE* mode. For manual operation (selected with *LOCAL* softkey), the number of sweep points (trace points) will always be set to 1251.
- The stop frequency indicated in the table may be limited to the corresponding frequency of the R&S FSP, if required.

IEC/IEEE-bus command: SYST:LANG "SCPI" | "8560E" | "8561E" |
 "8562E" | "8563E" | "8564E" |
 "8565E" | "8566A" | "8566B" |
 "8568A" | "8568B" | "8594E"

Serial Interface Configuration

SETUP-GENERAL SETUP submenu:

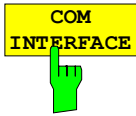

The *COM INTERFACE* softkey activates the *COM INTERFACE* table for entry of the serial interface parameters.

The following parameters can be configured in the table:

<i>Baud rate</i>	data transmission rate
<i>Bits</i>	number of data bits
<i>Parity</i>	bit parity check
<i>Stop bits</i>	number of stop bits
<i>HW-Handshake</i>	hardware handshake protocol
<i>SW-Handshake</i>	software handshake protocol
<i>Owner</i>	assignment to the measuring instrument or computer

COM INTERFACE	
Baud	9600
Bits	8
Parity	NONE
Stopbits	2
HW-Handshake	NONE
SW-Handshake	NONE
Owner	INSTRUMENT

Baud – Data transmission rate

The FSP supports baud rates between 110 and 19200 baud. The default setting is 9600 baud.

BAUD RATE
19200
✓9600
4800
2400
1200
600
300
110

IEC/IEEE-bus command: SYST:COMM:SER:BAUD 9600

Bits – Number of data bits per word

For the transmission of text without special characters, 7 bits are adequate. For binary data as well as for text with special characters, 8 bits must be selected (default setting).

BITS
7
✓8

IEC/IEEE-bus command: SYST:COMM:SER:BITS 7

Parity – Bit parity check

NONE no parity check (default setting)
EVEN even parity check
ODD odd parity check



IEC/IEEE-bus command: `SYST:COMM:SER:PAR NONE`

Stop bits – Number of stop bits

Available are 1 and 2. The default setting is 1 stop bit.



IEC/IEEE-bus command: `SYST:COMM:SER:SBIT 1`

HW-Handshake – Hardware handshake protocol

The integrity of data transmission can be improved by the use of a hardware handshake mechanism, which effectively prevents uncontrolled transmission of data and the resulting loss of data bytes. For hardware handshake additional interface lines are used to transmit acknowledge signals with which the data transmission can be controlled and, if necessary, stopped until the receiver is ready to receive data again.

A prerequisite for using hardware handshaking is, however, that the interface lines (DTR and RTS) are connected on both transmitter and receiver. For a simple 3-wire connection, this is not the case and hardware handshake cannot be used here.

Default setting is *NONE*.



IEC/IEEE-bus command: `SYST:COMM:SER:CONT:DTR OFF`
`SYST:COMM:SER:CONT:RTS OFF`

SW-Handshake – Software handshake protocol

Besides the hardware handshake mechanism using interface lines, it is also possible to achieve the same effect by using a software handshake protocol. Here, control bytes are transmitted in addition to the normal data bytes. These control bytes can be used, as necessary, to stop data transmission until the receiver is ready to receive data again.

In contrast to hardware handshaking, software handshaking can be realized even for a simple 3-wire connection.

One limitation is, however, that software handshaking cannot be used for the transmission of binary data, since the control characters XON and XOFF require bit combinations that are also used for binary data transmission.

Default setting is *NONE*.



IEC/IEEE-bus command: `SYST:COMM:SER:PACE NONE`

Owner – Assignment of the interface

The serial interface can be assigned alternatively to the measuring instrument section or to the computer section

If the interface is assigned to one section of the instrument, it is not available to the other section.

INSTRUMENT The interface is assigned to the measuring instrument section. Outputs to the interface from the computer section are not possible will get lost.

OS The interface is assigned to the computer section. It cannot be used by the measuring instrument section. This means that remote control of the instrument via the interface is not possible.



IEC/IEEE-bus command: `--`

Setting Date and Time

SETUP-GENERAL SETUP submenu:

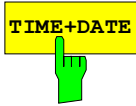

The *TIME+DATE* softkey activates the entry of time and date for the internal realtime clock.

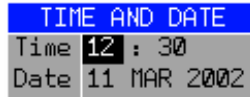

Time - Input of time

In the corresponding dialog box, the time is partitioned into two input fields so that hours and minutes can be entered independently.

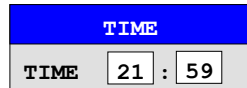

IEC/IEEE-bus command: SYST:TIME 21,59

Date - Input of Date

In the corresponding dialog box, the date is partitioned into 3 input fields so that day, month and year can be input separately.



For the selection of the month, pressing a unit key opens a list of abbreviations wherein the desired month can be selected.

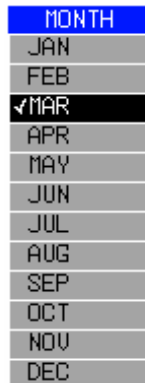

IEC/IEEE-bus command: SYST:DATE 1999,10,01

Configuration of Network Settings FSU

The instrument can be connected to an Ethernet LAN (local area network) by means of the LAN Interface FSU. This allows data transmission via the network and the use of network printers. The network card is able to handle both 10 MHz Ethernet IEEE 802.3 and 100 MHz Ethernet IEEE 802.3u. For more details see section 'LAN Interface FSU'.

SETUP - GENERAL SETUP - menu:



The *CONFIGURE NETWORK* softkey opens the dialog box with the network settings.

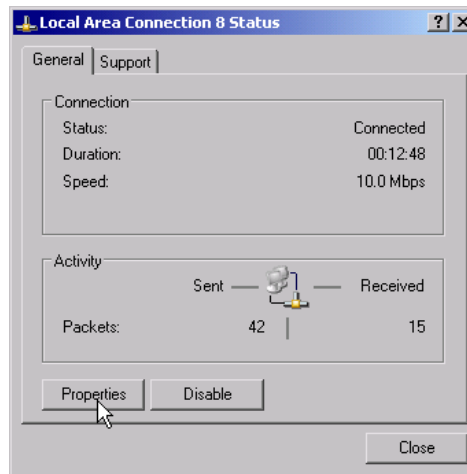

The softkey is used to modify an existing network configuration after the corresponding tabs are selected (see subsection "Configuration of Already Installed Network Protocols" in the section "Option FSP-B16 – LAN Interface").

- Notes:**
- A PC keyboard with trackball (or mouse instead) is required for the installation/configuration of the network support.
 - The softkey is only available with built-in LAN interface FSU

IEC/IEEE-bus command: -



The *NETWORK LOGIN* softkey opens the dialog box with the auto login settings.



When a network is installed, the preset user name 'Instrument' and the password 'instrument' can be adapted to a new user (see section 'Defining Users' in the LAN interface manual).

With the 'Auto Login' option active, an automatic registration is performed during booting with the specified user name and password. Otherwise the Windows XP login request is displayed during booting.

- Notes:**
- A PC keyboard with trackball (or additional mouse instead) is required for the installation/configuration of the network support.
 - The softkey is only available with built-in LAN interface FSU.

IEC/IEEE-bus command: -

Enabling Firmware Options

The *OPTIONS* softkey opens a submenu that allows license keys for firmware options to be entered. Previously installed options are displayed in a table that opens automatically.

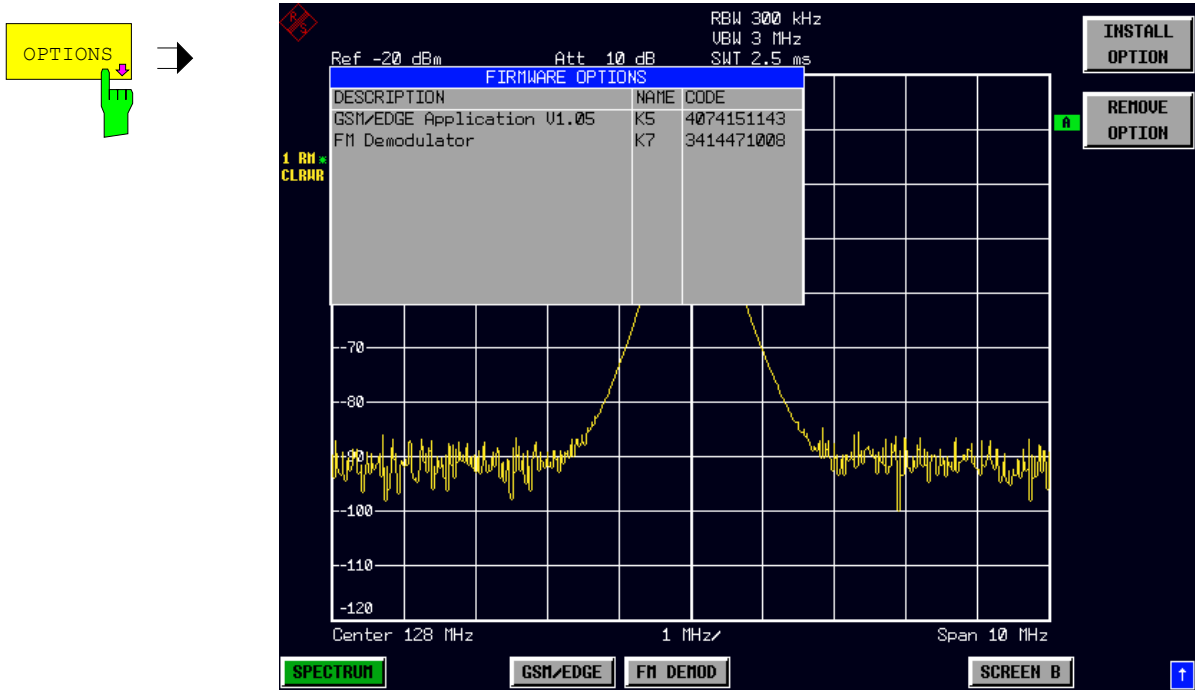

Softkey *INSTALL OPTION* opens the data entry for the license keycode of a firmware option.

On entry of a valid license key the message *OPTION KEY OK* is displayed in the status line and the firmware option appears in table *FIRMWARE OPTIONS*.

On entry of an invalid license key the message *OPTION KEY INVALID* is displayed in the status line.

IEC/IEEE-bus command: --



Softkey *REMOVE OPTION* removes all firmware options from the instruments. Execution of this function must be confirmed in a message box in order to avoid removal of the firmware options by mistake.

IEC/IEEE-bus command: --

Emulation of the Instrument Front Panel

SETUP - GENERAL SETUP – NEXT menu:

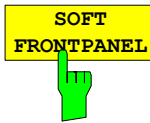

The *SOFT FRONTPANEL* softkey switches the display of the front-panel keys on and off.

When the front-panel keys are displayed on the screen, the instrument can be controlled by clicking the respective button with the mouse. This is especially useful when the instrument in a different site is controlled via a remote-control program, such as, for instance, the remote desktop of Windows XP, and the screen contents are transferred to the controller via remote link (see the section "LAN Interface - Remote Desktop under Windows XP).

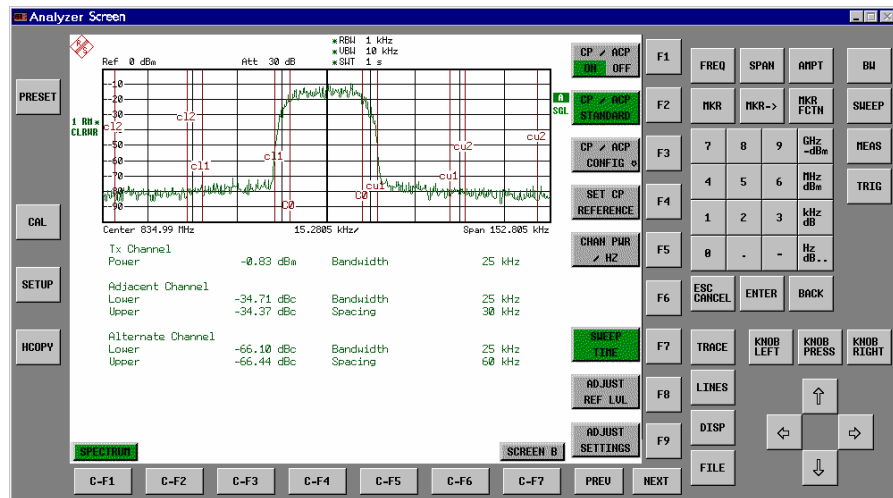

Note:

Display resolution:

When the display of the front-panel keys is switched on, the screen resolution of the instrument changes to 1024x768 pixels. Only a section of the total screen is then displayed on the LC display, which will automatically be shifted on mouse moves.

In order to obtain a complete display of the user interface, an external monitor is to be plugged into the corresponding connector at the rear panel. Prior to performing the resolution change the user is prompted for confirmation whether the required monitor is connected.

Switching off the front-panel display restores the original screen resolution.

Key assignment:

Button labels largely correspond to those of the front-panel keys. The rotation function of the rotary knob is assigned to the 'KNOB LEFT' and 'KNOB RIGHT' buttons, the press function (<ENTER>) to 'KNOB PRESS'.

The labels of the softkey buttons (F1 to F9) and of the hotkey buttons (C-F1 to C-F7) indicate that the keys can be operated directly by means of the corresponding function keys F1 to F9 or <CTRL>F1 to <CTRL>F7 of a PS/2 keyboard.

IEC/IEEE-bus command: SYST:DISP:FPAN ON

System Information

The *SYSTEM INFO* softkey opens a submenu in which detailed information on module data, device statistics and system messages is displayed.

SETUP menu:



Display of Module Data

SETUP SYSTEM INFO submenu:

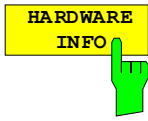

The *HARDWARE INFO* softkey opens a table in which the modules (INSTALLED COMPONENTS) installed in the instrument are listed together with the corresponding hardware revisions.

Table *HARDWARE INFO* consists of six columns:

- SERIAL # serial number
- COMPONENT name of module
- ORDER # order number
- MODEL model number of the module
- REV main modification index of the module
- SUB REV secondary modification index of the module

HARDWARE INFO						
COMPONENT	SERIAL #	ORDER #	MODEL	REV	SUB REV	
RF_ATTEN_7	688557/005	1067.7684	00	21	00	↑
FRONTEND1	833387/003	1093.5540	03	07	11	
FRONTEND2	683346/053	1093.5791	03	05	12	
IF-FILTER/REF	689712/002	1093.7242	02	04	04	
DETECTOR	683999/035	1093.6998	02	03	04	
AF_DEMOD	665087/002	1093.7620	02	03	03	
CPU-Board	991025/687	1091.2489	00	04	11	
MOTHERBOARD	675631/022	1093.7494	02	05	04	
FSP	833387/026	1093.4495	03	00	00	
LAN Interface	821818/018	1093.9080	00	00	80	↓

Note: The screenshot lists the components of an FSP 7 with options FSP-B3 (AF demodulator) and FSP-B16 (LAN interface).

Display of Device Statistics

SETUP SYSTEM INFO submenu:

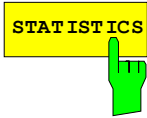

The *STATISTICS* softkey opens the table *STATISTICS*. This table contains the model information, serial number and firmware version, and a list in which the operating time of the instrument, the power-on cycles as well as attenuator switching cycles are displayed.

FIRMWARE VERSIONS - STATISTICS	
Model	FSP-7
Serial #	123456789
Firmware Rev.	1.40
BIOS Rev.	V1.5-26-3
Operating Time (hours)	1994
Power On Cycles	488
Attenuator Cycles	
Input RF/Cal	12380
10dB	68977
20dB	57314
40dB	32699
El. Attenuator Cycles	
5dB	19055
Bypass	4398
PreAmp	921

IEC/IEEE-bus command: --

Display of System Messages

SETUP SYSTEM INFO submenu:

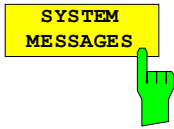

The *SYSTEM MESSAGES* softkey opens a submenu including a table in which the generated system messages are displayed in the order of their occurrence. The most recent messages are placed at the top of the list.

The following information is available:

No	Device-specific error code
MESSAGE	Brief description of the message
COMPONENT	On hardware messages: name of the affected module
	On software messages: if needed, the name of the affected software components
DATE/TIME	Date and time of the occurrence of the message

Messages that have occurred since the last call to the *SYSTEM MESSAGES* menu are marked with an asterisk '*'.

The *CLEAR ALL MESSAGES* softkey is activated and allows clearing of the error buffer.

If the number of error messages exceeds the capacity of the error buffer, the message appearing first is "Message buffer overflow".

SYSTEM MESSAGES			
NO	MESSAGE	COMP.	DATE/TIME
107	Reference is Unlocked	DCON	07.MAR.02; 14:03:19
110	Error 110 size of block too big. Block id 10616	CDS	07.MAR.02; 10:38:45
110	Checksum error RF attenuator Block id 10616	CDS	07.MAR.02; 10:38:45

IEC/IEEE-bus command: SYST:ERR?



The *CLEAR ALL MESSAGES* softkey deletes all messages in the table. The softkey is only available when table *SYSTEM INFO* is active.

IEC/IEEE-bus command: SYST:ERR?

Service Menu

The service menu offers a variety of additional functions which are used for maintenance and/or trouble shooting.



Caution:

The service functions are not necessary for normal measurement operation. However, incorrect use can affect correct operation and/or data integrity of the FSP.

Therefore, many of the functions can only be used after entering a password. They are described in the instrument service manual.

SETUP menu:

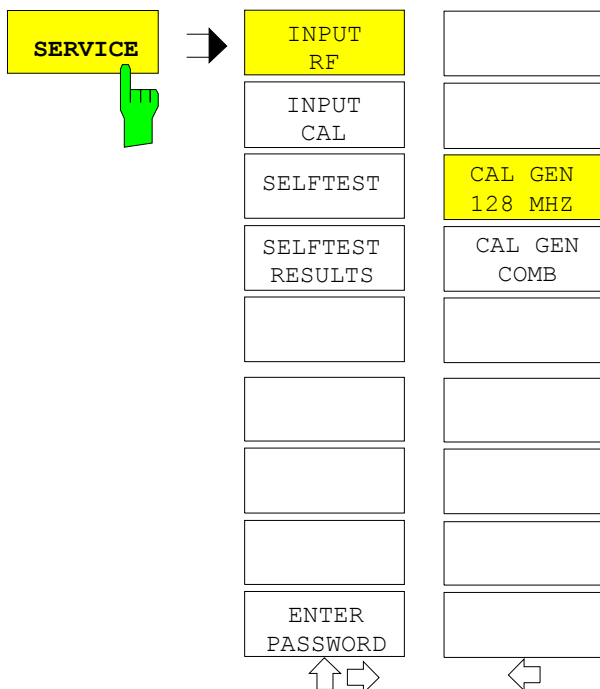

The *SERVICE* softkey opens a submenu for selection of the service function.

The *INPUT RF* and *INPUT CAL* softkeys are mutually exclusive selection switches. Only one switch can be active at any one time.

General Service Functions

SETUP SERVICE submenu:

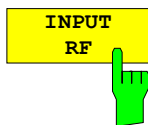

The *INPUT RF* softkey switches the input of the FSP to the input connector (normal position).

After *PRESET*, *RECALL* or FSP power on, the *INPUT RF* is always selected.

IEC/IEEE-bus command: `DIAG:SERV:INP RF`

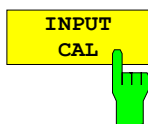

The *INPUT CAL* softkey switches the RF input of the FSP to the internal calibration source (128 MHz) and activates the data entry of the output level of the calibration source. Possible values are 0 dB and -30 dB.

IEC/IEEE-bus command: `DIAG:SERV:INP CAL;`
`DIAG:SERV:INP:CSO 0 DBM`



The *ENTER PASSWORD* softkey allows the entry of a password.

The FSP contains a variety of service functions which, if incorrectly used, can affect correct operation of the analyzer. These functions are normally not accessible and are only usable after the entry of a password (see instrument service manual).

IEC/IEEE-bus command: `SYST:PASS "Password"`

SETUP SERVICE NEXT submenu:

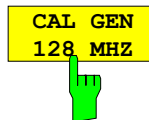

The *CAL GEN 128 MHZ* softkey selects a sinusoidal signal at 128 MHz as output signal for the internal calibration source. The internal pulse generator will be switched off.

Note:

The softkey is only available if the optional Broadband Calibration Source FSP-B15 is fitted.

IEC/IEEE-bus command: `DIAG:SERV:INP:PULS OFF`



The *CAL GEN COMB* softkey switches the internal pulse generator on and allows the pulse frequency to be entered.

For model FSP40 the pulse frequency 640 MHz is selected.

With option FSP-B15 the selectable pulse frequencies are 10 kHz and 62.5 kHz.

Note:

The softkey is only available for model FSP40 or if the optional Broadband Calibration Source FSP-B15 is fitted.

IEC/IEEE-bus command `DIAG:SERV:INP:PULS ON;`
`DIAG:SERV:INP:PRAT 62.5KHZ`

Selftest

SETUP SERVICE submenu:



The *SELFTTEST* softkey initiates the selftest of the instrument modules.

With this function the instrument is capable of identifying a defective module in case of failure.

During the selftest a message box appears in which the current test and its result is shown. The test sequence can be aborted by pressing ENTER ABORT.

All modules are checked consecutively and the test result (selftest PASSED or FAILED) is output in the message box.

IEC/IEEE-bus command: *TST?



The *SELFTTEST RESULTS* softkey calls the *SELFTTEST* table in which the results of the module test are displayed.

In case of failure a short description of the failed test, the defective module, the associated value range and the corresponding test results are indicated.

SELFTTEST RESULTS				
Total Selftest Status: user mode ---PASSED---				
Rohde&Schwarz,FSP-7,123456789,1.40				
Date (dd/mm/yyyy): 07/03/2002 Time: 14:04:29				
Runtime: 01:10				
Supply voltages detector [Volt]				
test description	min	max	result	state
+6V	5.70	6.60	6.06	PASSED
+8V	7.60	9.20	8.53	PASSED
+12V	11.39	13.20	12.45	PASSED
-12V	-14.27	-10.45	-12.44	PASSED
+28V	25.74	30.23	28.16	PASSED
-5V	-5.97	-4.06	-4.98	PASSED
-6V	-7.18	-4.86	-5.88	PASSED
Supply & ref. voltages IF-Filter [Volt]				
test description	min	max	result	state
TEMPERATURE	0.20	70.20	37.80	PASSED

IEC/IEEE-bus command: DIAG:SERV:STE:RES?

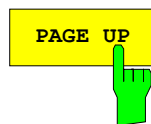

The *PAGE UP* or *PAGE DOWN* softkey sets the *SELFTTEST RESULTS* table to the next or previous page.

IEC/IEEE-bus command --

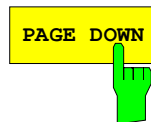

Hardware Adjustment

Some of the FSP modules can be realigned. This realignment can become necessary after calibration due to temperature drift or aging of components (see service manual instrument).



Caution:

The realignment should be carried out by qualified personnel since the changes considerably influence the measurement accuracy of the instrument. This is the reason why the softkeys **REF FREQUENCY**, **CAL SIGNAL POWER** and **SAVE CHANGES** can only be accessed after entering a password.

Firmware Update

The installation of a new firmware version can be performed using the built-in diskette drive. The firmware update kit contains several diskettes.

The installation program is called in the **SETUP** menu.

SETUP side menu:

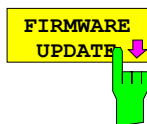

The **FIRMWARE UPDATE** softkey opens the subdirectory for installing/deinstalling new firmware versions.

IEC/IEEE-bus command: --

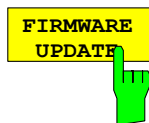

The **FIRMWARE UPDATE** softkey starts the installation program and leads the user through the remaining steps of the update

IEC/IEEE-bus command: --

The firmware update is started as follows:

Insert disk 1 into the floppy drive.

Call **SETUP** side menu via **[SETUP][NEXT]**

Start the update via **[FIRMWARE UPDATE]**



The **RESTORE FIRMWARE** softkey restores the previous firmware version

IEC/IEEE-bus command: --



The **UPDATE PATH** softkey is used to select the drive and directories under which the archive files for the firmware update are stored.

The firmware update can thus also be performed via network drives or USB memory sticks/USB-CD-ROM drives.

IEC/IEEE-bus command:

```
"SYST:FIRM:UPD 'D:\USER\FWUPDATE' "
```

Saving and Recalling Data Sets – FILE Key

Overview

The *FILE* key calls the following functions:

- Storage/loading functions for storing (*SAVE*) instrument settings such as instrument configurations (measurement/display settings, etc) and measurement results from working memory to permanent storage media, or to load (*RECALL*) stored data into working memory.
- Functions for management of storage media (*FILE MANAGER*). Included are among others functions for listing files, formatting storage media, copying, and deleting/renaming files.

The FSP is capable of internally storing complete instrument settings with instrument configurations and measurement data in the form of data sets. The respective data are stored on the internal hard disk or, if selected, on a floppy. The hard-disk and floppy-disk drives have the following names:

floppy disk A:
 hard disk D: (hard disk C: is reserved for instrument software)

The configuration of the softkeys in the menu is shown in the following figure:

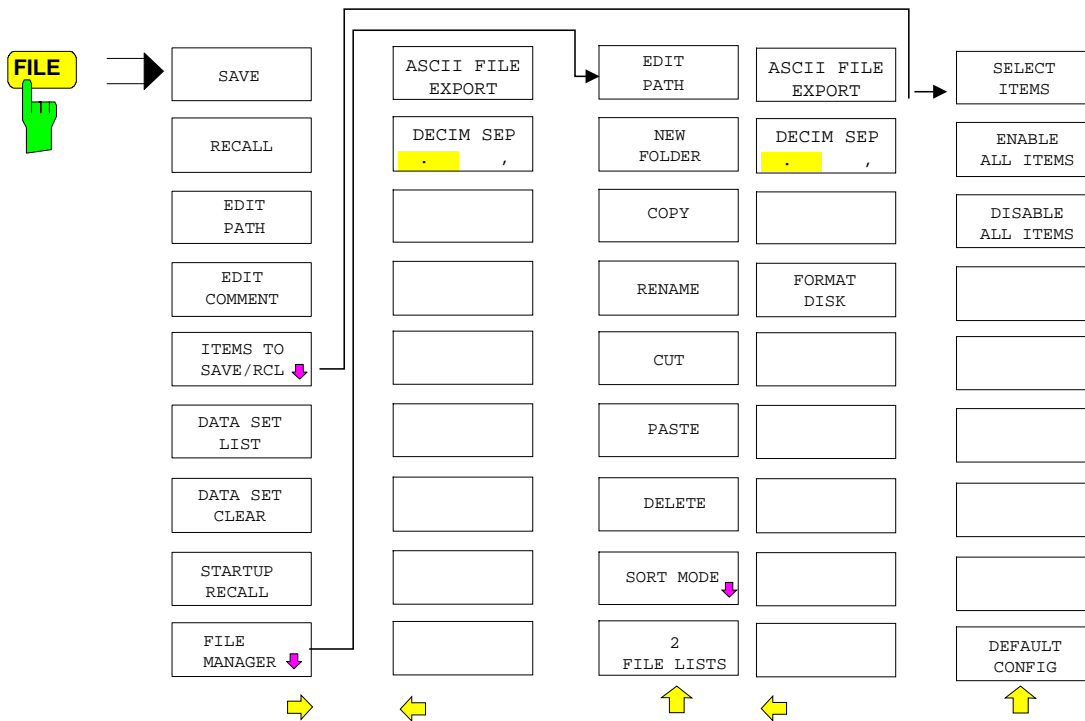



Storing a Device Configuration

Storing a Complete Device Configuration

The following steps are required to store a complete device configuration:

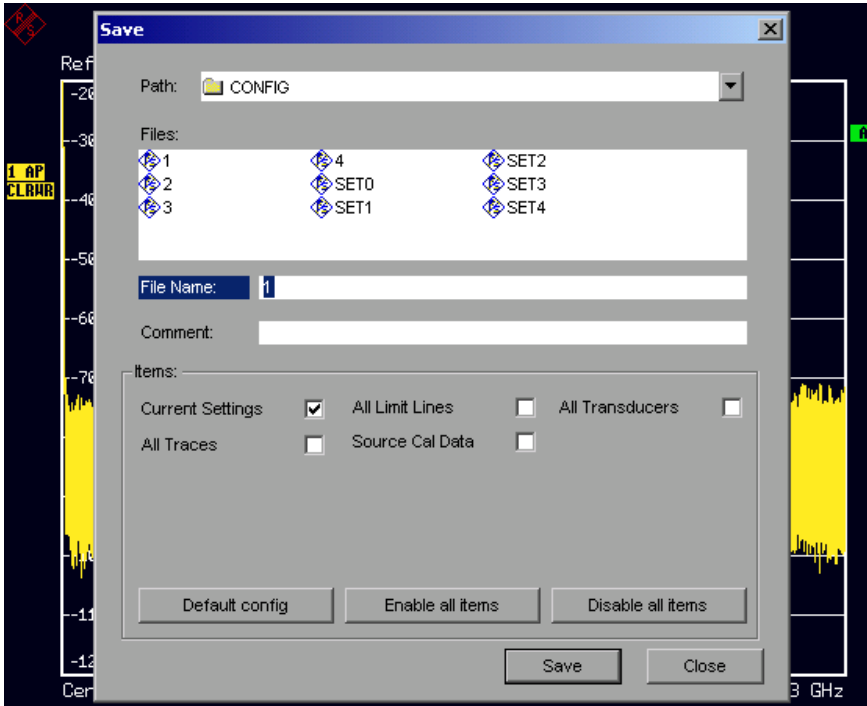
- Press the *FILE* key and then press the *SAVE* softkey.
The selection box for the device configuration will be opened:



- Enter the name of the data set to be stored (in the simplest case, a digit from 0 to 9) and press *ENTER*. The data set will be stored and the dialog window closed.
The name of the data set may comprise letters and digits; if required, the desired directory may precede the name of the data set (the directory will then automatically be used for further *SAVE* and *RECALL* processes).
The help line editor, which can be opened by pressing the *Cursor Down*  key, is available for entering file names via the front-panel keypad.
For further information on the operation of this editor, see section "Entering Text using the Help Line Editor".

How to enter comments, change the path for the file to be stored and select the data set from a list is described under the associated softkeys *EDIT COMMENT*, *EDIT PATH* and *DATA SET LIST*.

The default path for the device configuration is D:\USER\CONFIG. The file names of the data sets have the extension .FSP.

Storing Parts of a Device Configuration

To store part of a data set (e.g. "All Transducers"), the partial data set has to be selected beforehand. The following steps are required:

- Press the *FILE* key and then the *SAVE* softkey.
- Press the *ITEMS TO SAVE/RCL* softkey. The entry focus moves to the first entry in the **Items** field.
- Use the spinwheel to move the entry focus to the desired entry in the **Items** field and select the partial data set by pressing the spinwheel or *ENTER*. The selection of already highlighted partial data sets

can be cancelled by pressing the spinwheel / ENTER again.

Softkeys *ENABLE ALL ITEMS* / *DISABLE ALL ITEMS* are also available to select all partial data sets or to cancel the selection.

- Move the entry focus to the field *File Name* using the spinwheel and activate the text entry by pressing the spinwheel.
- Enter file names and store the data set with *ENTER*.

Loading a Data Set:

A data set may be loaded in two different ways:

1. Direct entry of data set name:

- Press the *FILE* key and then press the *RECALL* softkey.
- Enter the name of the data set to be stored (in the simplest case, a digit from 0 to 9) and press *ENTER*. The data set will be loaded.

The name of the data set may comprise letters and digits; if required, the desired directory may precede the name of the data set (the directory will then automatically be used for further *SAVE* and *RECALL* processes).

The help line editor, which can be opened by pressing the *Cursor Down*  key, is available for entering file names via the front-panel keypad.

For further information on the operation of this editor, see section "Entering Text using the Help Line Editor".

2. Selection of data set via a selection list:

- Press the *FILE* key and then press the *RECALL* softkey.
- Press the *ITEMS TO SAVE/RCL* softkey.

The list of available data sets will be selected:

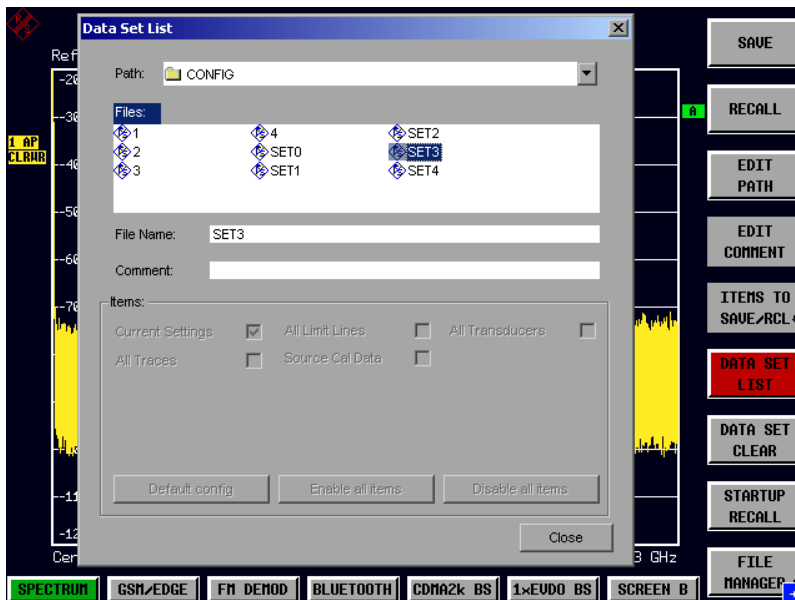

- Select the data set to be loaded with the spinwheel and confirm twice with *ENTER*. The data set will be loaded.

If the path for the device configuration is to be changed, this is done via the *EDIT PATH* softkey.

When loading device data, the settings of the unloaded partial data sets will remain unchanged. The R&S FSP recognizes which parts the loaded data set has and ignores selected but unavailable partial data sets.

Automatic Loading of a Data Set during Booting

When the R&S FSP is delivered, it will load the device setting last activated when the unit was switched off (provided that the unit was switched off via the *STANDBY* switch at the front panel, see section 1 "Putting the Device Into Operation").

Moreover, the R&S FSP is also able to automatically load a user-defined data set. The following operating steps are required:

- Press the *FILE* key and then press the *RECALL* softkey.
 - Press the *STARTUP RECALL* softkey.
- The list of available data sets will be selected:

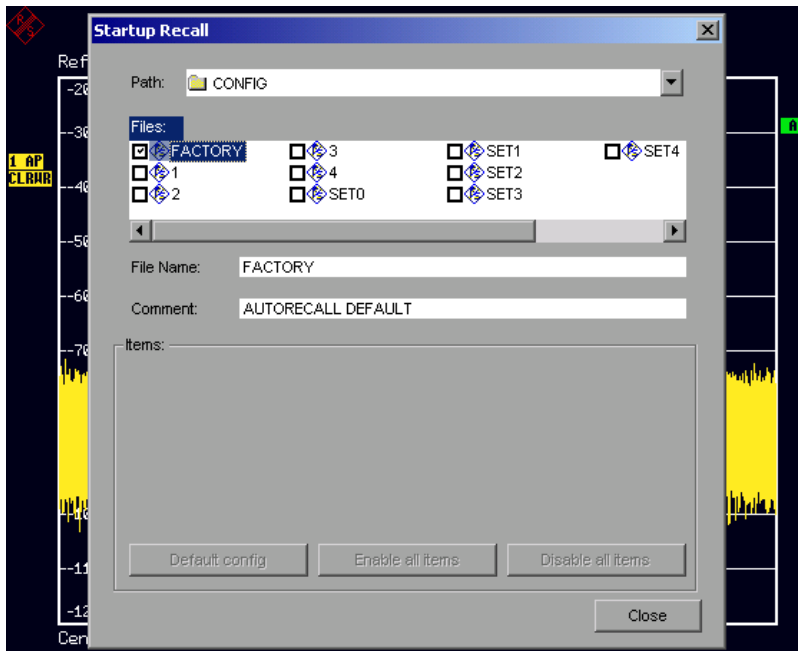

- Select the data set to be loaded using the spinwheel and mark with *ENTER*.

Notes:

1. The selected data set will also be loaded when pressing the *PRESET* key.
2. The entry *FACTORY* will load the last setting that was activated prior to switch-off when the unit is started after delivery.

- Close the dialog window by pressing *ESC* twice.

If the path is to be changed for the device configuration, this is done via the *EDIT PATH* softkey.

Copying Data Sets to Disk

The saved files of the data sets can be copied from one storage medium (e.g. drive D:) to another storage medium (e.g. drive A:) or to another directory using the functions found in the *FILE MANAGER* submenu. The file extension *.FSP* must not be changed.

EnteringText with the Help Line Editor





The help line editor is opened as soon as the *CURSOR DOWN*  key is pressed on a text entry field (*File Name, Comment*):

													1	2	3	4	5	6	7	8	9	0
A	B	C	D	E	F	G	H	I	J	K	L	M	:	\	.	/	^	+	-	=	,	
H	O	P	Q	R	S	T	U	V	W	X	Y	Z	<	>	()	{	}	[]	#	~
a	b	c	d	e	f	g	h	i	j	k	l	m	'	@	:		?	!	"	€	\$	%
n	o	p	q	r	s	t	u	v	w	x	y	z	«	»	BACK	EXIT						
SPACE																						

The entry range consists of two parts:

- editing line
- character selection field

Die *CURSOR DOWN*  key is used to move from the editing line to the character selection field.

The navigation in the character selection field is by means of the spinwheel or the cursor keys , ,  and .



The desired characters are transferred to the editing line by pressing the spinwheel or by pressing the *ENTER* key:

Default Spectrum													1	2	3	4	5	6	7	8	9	0
A	B	C	D	E	F	G	H	I	J	K	L	M	:	\	.	/	^	+	-	=	,	
H	O	P	Q	R	S	T	U	V	W	X	Y	Z	<	>	()	{	}	[]	#	~
a	b	c	d	e	f	g	h	i	j	k	l	m	'	@	:		?	!	"	€	\$	%
n	o	p	q	r	s	t	u	v	w	x	y	z	«	»	BACK	EXIT						
SPACE																						

The fields of the last line of the character selection field have special functions:

SPACE adds a space to the editing line
 << moves the cursor in the editing line by one character towards the left
 >> moves the cursor in the editing line by one character towards the right
 BACK deletes the character in front of the cursor
 EXIT stores the contents of the editing line and closes the help line editor

A return to the editing line is possible via the *CURSOR UP*  key (return from the top line of the character selection field).

Within the editing line, navigation is also performed by means of the spinwheel or the cursor keys  and .

Digits, decimal points and signs are directly entered into the editing line via the keys of the numeric block provided at the front panel. With a PC keyboard connected, letters and special characters can also be entered directly.

Editing is terminated via *ENTER* if the text is to be stored and via *ESC* if the text is to be discarded. The help line editor will be closed in both cases.

Description of the Individual Softkeys

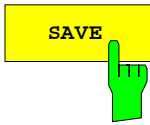

The **SAVE** softkey opens the dialog window for entering the data set to be stored.

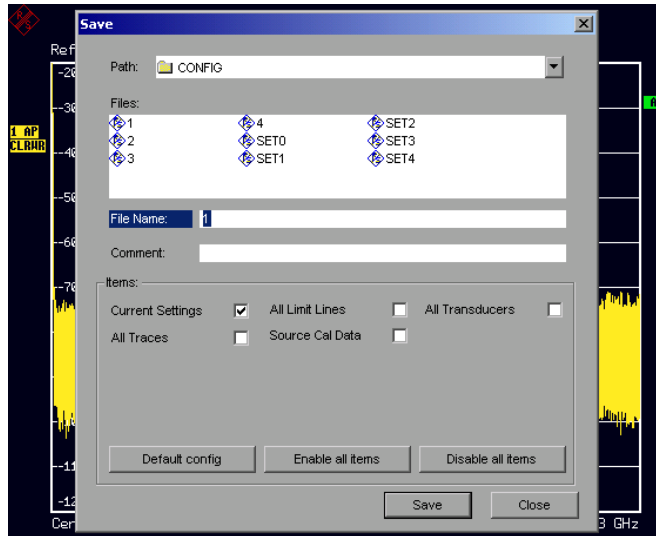

The **SAVE** table contains the entry fields for editing the data set:

- Path** Directory in which the data set is stored.
- Files** List of data sets already stored.
- File Name** Name of data set.
The name can be entered with or without drive name and directory; the drive name and directory, if available, will then appear in the **PATH** field. The extension of the data name is ignored.
- Comment** Comment regarding the data set.
- Items** Selection of settings to be stored.

IEC/IEEE command: `MMEM:STOR:STAT 1, "a:\test02"`

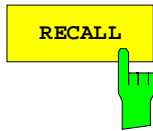

The *RECALL* softkey activates the dialog window to enter the data set to be loaded.

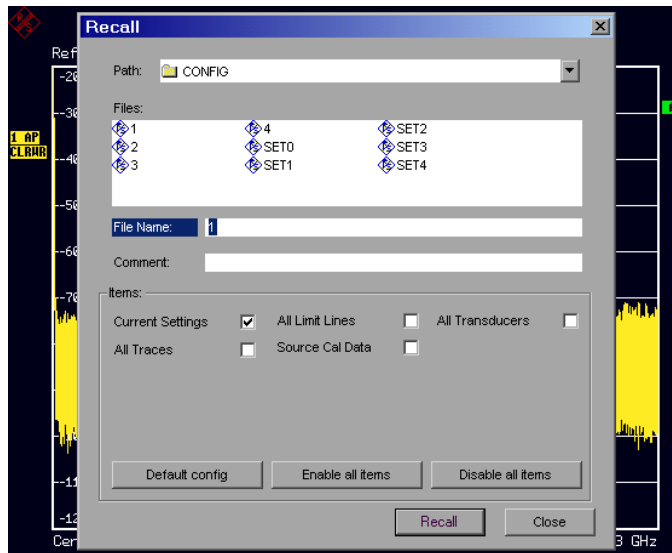

The *RECALL* table shows the current settings regarding the data set:

<i>Path</i>	Directory in which the data set is stored.
<i>Files</i>	List of stored data sets
<i>File Name</i>	Name of data set. The name can be entered with or without drive name and directory. The drive name and directory will then appear in the Path field. A potential extension of the file name is ignored.
<i>Comment</i>	Comment regarding data set.

IEC/IEEE command: `MMEM:LOAD:STAT 1,"a:\test02"`



The *EDIT PATH* softkey activates the entry of a path name for the device configuration to be stored/to be loaded:

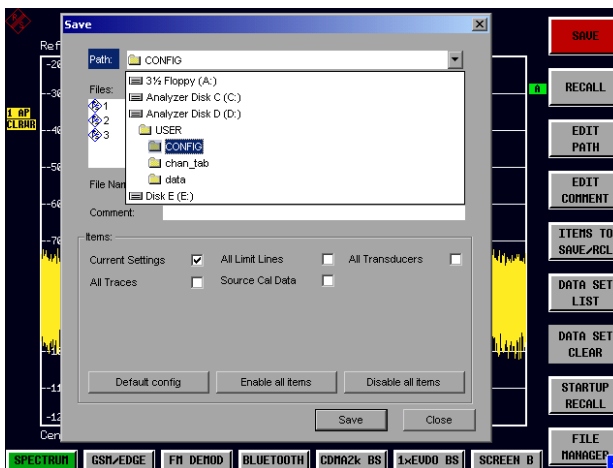

The desired directory is selected with the spinwheel or the *CURSOR UP / DOWN* key and is confirmed by pressing the spinwheel or the *ENTER* key.

Subdirectories are opened by the *CURSOR RIGHT*  key and closed with the *CURSOR LEFT*  key.

IEC/IEEE-bus command -

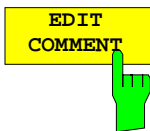

The *EDIT COMMENT* softkey activates the entry of commentary concerning the current data set. The help line editor is opened with *CURSOR DOWN*. A total of 60 characters are available for this purpose.

Note:

For further information on how to enter the comment text via the front panel of the unit, see the section "Entering Text using the Help Line Editor".

IEC/IEEE command: `MMEM:COMM "Setup fuer GSM Messung"`

The *SEL ITEMS TO SAVE/RCL* softkey opens a submenu for selecting the data subsets.

FILE - ITEMS TO SAVE/RCL submenu:

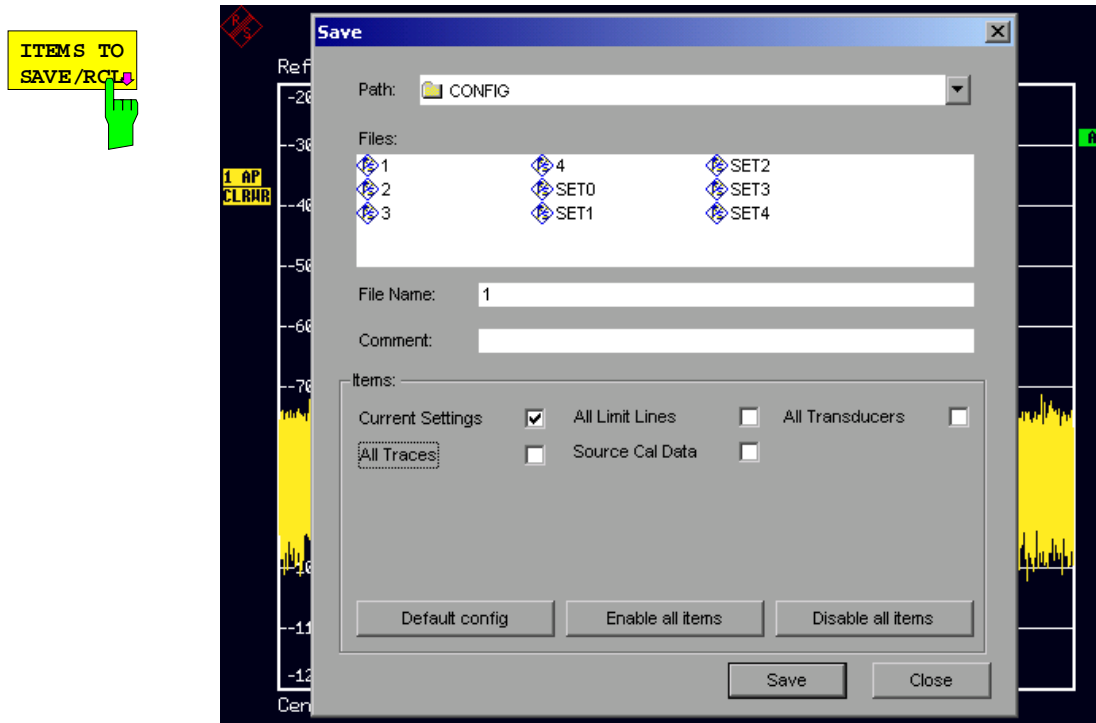

The Dialog *SaveL* table offers the following selectable data subsets in the *Items* field:
Current Settings

These settings include:

- current configuration of general instrument parameters
- current measurement hardware settings
- active limit lines:
 A data set may contain maximum 8 limit lines for each window. It always contain the activated limit lines and the de-activated limit lines used last, if any. Consequently, the combination of the restored de-activated limit lines depends on the sequence of use with command `MMEM:LOAD`.
- the activated transducer factor
- user-defined colour settings
- configuration for hardcopy output
- settings of tracking generator (only with option tracking generator)
- settings of tracking generator (only with option)

All Limit Lines
All Transducer
All Traces
Source Cal Data

all limit lines
 all transducer factors
 all traces which are not blanked
 correction data for tracking generator (only with options B9 / B10)



The *SELECT ITEMS* softkey moves the selection bar to the first line, left column of the *Items* field. An entry is selected. Position the entry focus to the corresponding partial data set using the cursor keys and then press the *ENTER* key in the desired line. The selection is cleared by pressing the key again.

IEC/IEEE command:

Current Settings:	MMEM:SEL:HWS ON
All Limit Lines:	MMEM:SEL:LIN:ALL ON
All Traces:	MMEM:SEL:TRAC ON
Source Cal Data:	MMEM:SEL:SCD ON



The *ENABLE ALL ITEMS* softkey marks all partial data sets.

IEC/IEEE command: MMEM:SEL:ALL

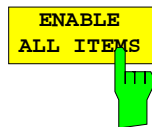

The *ENABLE ALL ITEMS* softkey marks all partial data sets.

IEC/IEEE-bus command MMEM:SEL:ALL

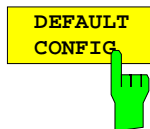

The *DEFAULT CONFIG* softkey establishes the default selection of the data subset to be saved and outputs *DEFAULT* in the *ITEMS* field of the *SAVE/RECALL DATA SET* table.

IEC/IEEE command: MMEM:SEL:DEF

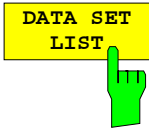

The *DATA SET LIST* softkey sets the entry focus to the list *Files* of all available data sets. In addition, the *DATA SET CLEAR* softkey are displayed.

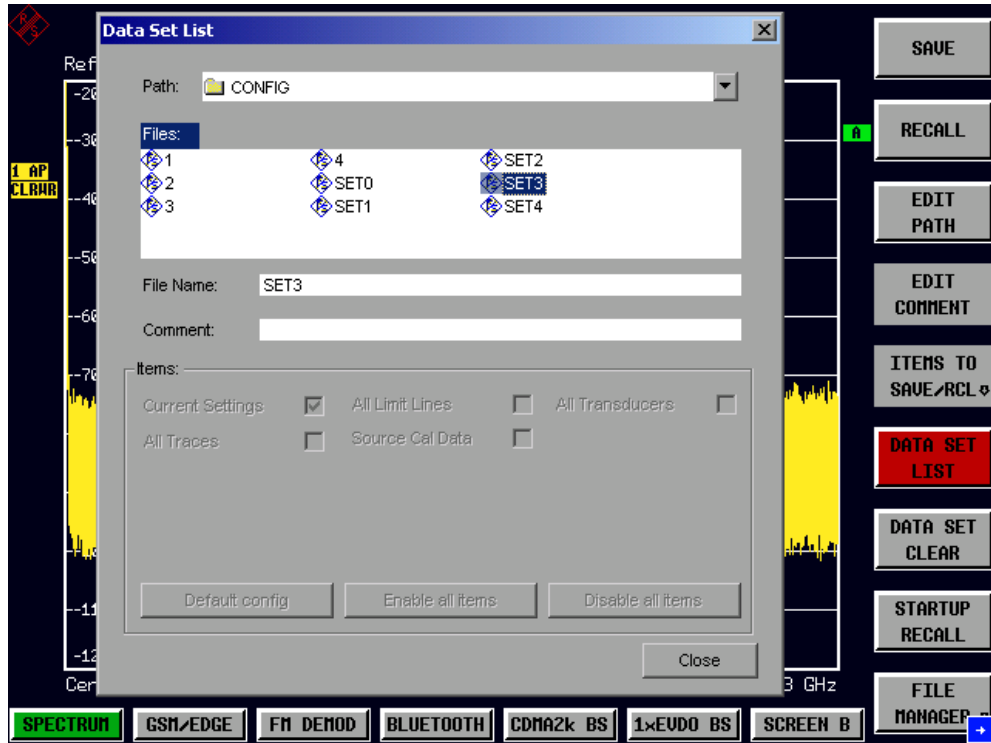

The list *Files* lists all data sets which are stored in the selected directory.

The *Comment* and *Items* fields in the *DATA SET CONTENTS* column indicate the saved data subsets and the comment for the currently selected data set.

IEC/IEEE command: ---

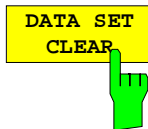

The *DATA SET CLEAR* softkey deletes the selected data set

IEC/IEEE command: `MMEM:CLE:STAT 1, "test03"`

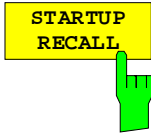

The *STARTUP RECALL* softkey activates the selection of a data set which is automatically loaded when the instrument is powered on and after *PRESET*. For this purpose the Dialog *Startup Recall* is opened (analogously to *DATA SET LIST*).

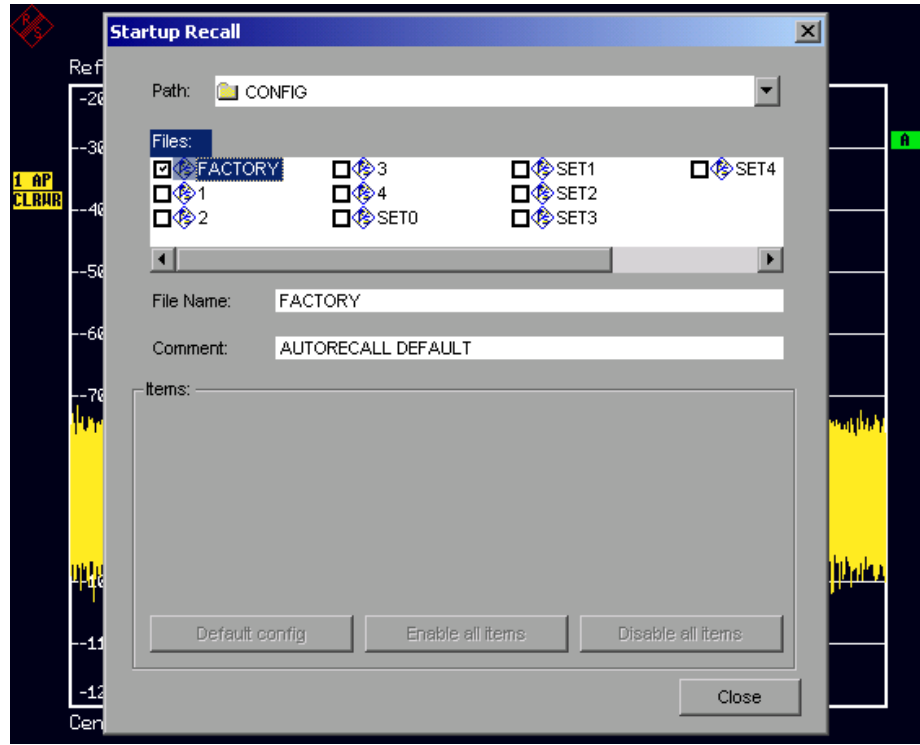

The field *Files* lists all data sets stored in the selected directory. The currently selected data set is checked.

In addition to the data sets stored by the user, the data set *FACTORY*, which specifies the settings of the instrument before it was last switched off (Standby), is always present (when unit is delivered).

To select a data set, the entry focus is set to the corresponding entry by means of the spinwheel and the data set is activated by pressing the spinwheel or the *ENTER* key.

If a data set other than *FACTORY* is chosen, this data set will be loaded when the unit is switched on or after pressing the *PRESET* key. Any settings can be assigned to the *PRESET* key.

IEC/IEEE command: `MMEM:LOAD:AUTO 1, "D:\user\config\test02"`

Operating Concept of File Managers

The *FILE MANAGER* softkey opens a menu for managing storage media and files.

FILE - FILE MANAGER submenu:

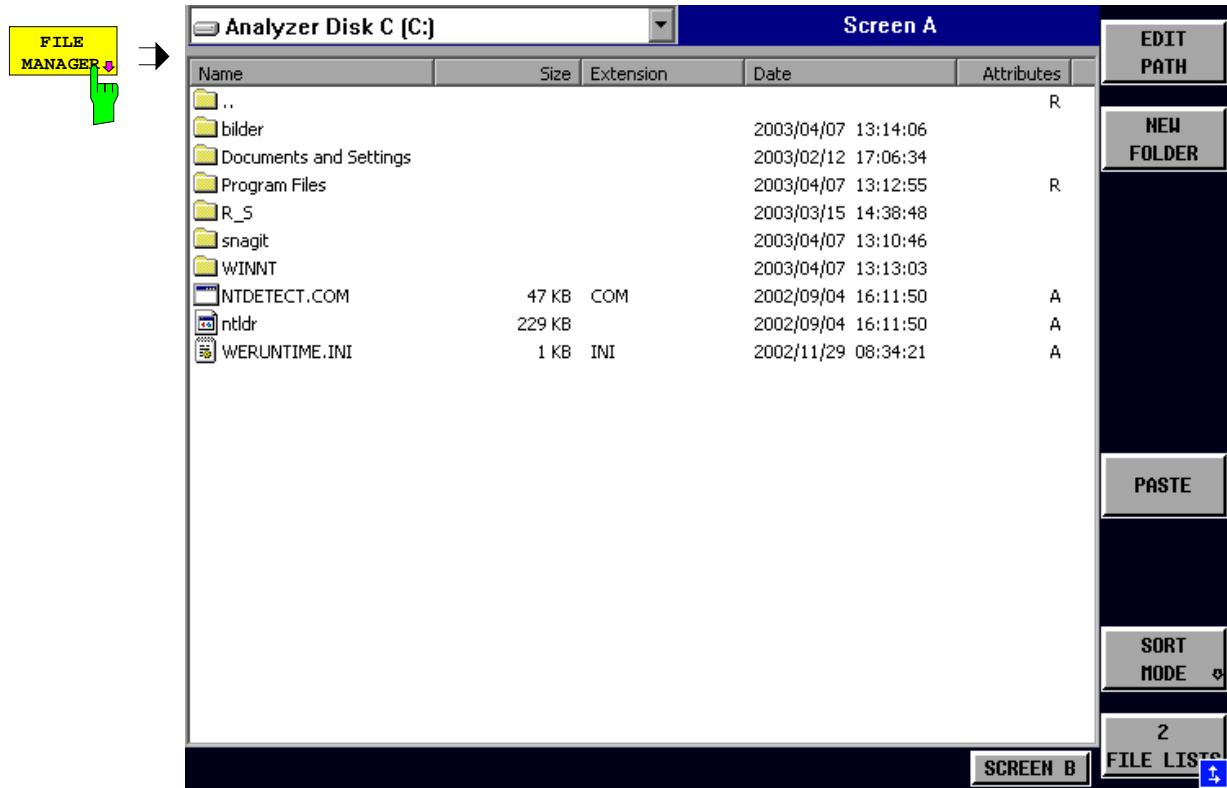

The designation and the letter of the current drive are displayed in the upper left corner of the File Manager dialog.

The table below shows the files of the current directory and potential subdirectories.

A file or a directory in the table is selected via cursor keys. The *ENTER* key is used to switch from one subdirectory to another. The softkeys *COPY*, *RENAME*, *CUT* and *DELETE* are only visible if the entry focus is set to a file and not to a directory.

The dots ".." open up the next higher directory.

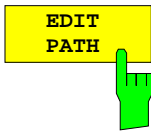

The *EDIT PATH* softkey activates the input of the directory which will be used in subsequent file operations.

The new path is included in the *FILE MANAGEMENT* table.

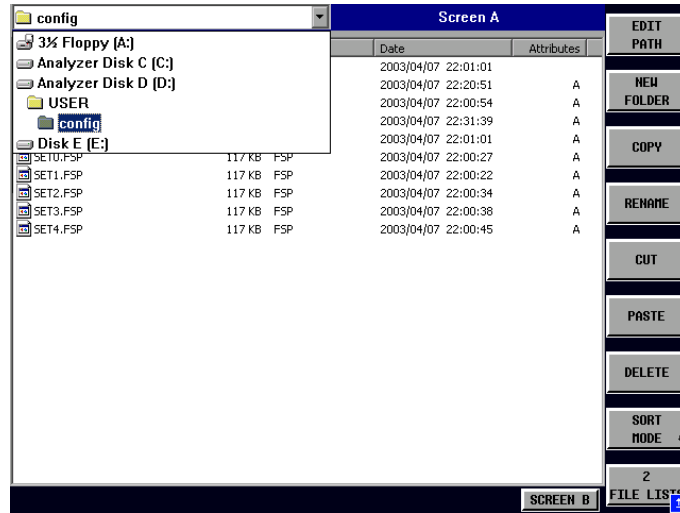

Use *CURSOR UP / DOWN* to select a drive and confirm your selection with *ENTER*.

Open subdirectories by using *CURSOR RIGHT*, and use *CURSOR LEFT* to close them again.

When you have found the subdirectory you looked for, mark it with *ENTER*.

IEC/IEEE command: MMEM:MSIS "a: "
 MMEM:CDIR "D:\user "

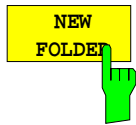

The *NEW FOLDER* softkey creates subdirectories.

The entry of an absolute path name (e.g. "\USER\MEAS") as well as the path relative to the current directory (e.g. "..\MEAS") is possible.

IEC/IEEE command: MMEM:MDIR "D:\user\test"

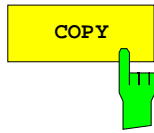

The *COPY* softkey opens the help line editor to enter the target directory for a copying process. The file is also copied into the clipboard and can be copied into a different directory at a later time by means of *PASTE*.

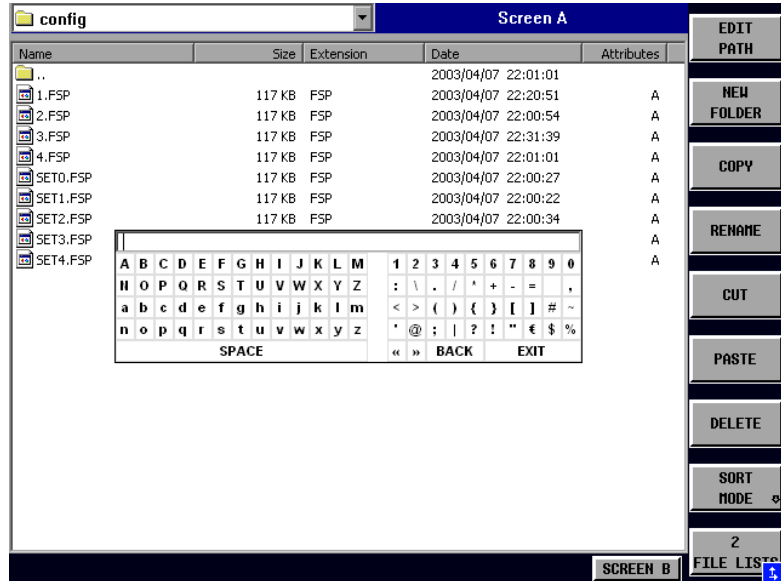

Files can also be copied to a different storage medium by indicating a certain drive letter (e.g. D:). The selected files or directories will be copied after terminating the entry with the ENTER key.

IEC/IEEE-bus command `MMEM:COPY "D:\user\set.cfg", "a:"`

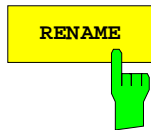

The *RENAME* softkey opens the help line editor to rename a file or a directory (analogously to the *COPY* softkey).

IEC/IEEE command: `MMEM:MOVE "test02.cfg", "set2.cfg"`

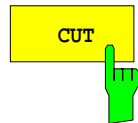

The *CUT* softkey shifts the selected file into the clipboard from where it can be copied into a different directory at a later time by means of *PASTE*.

Note:

The file in the output directory will only be deleted if the *PASTE* softkey has been pressed.

IEC/IEEE-bus command -

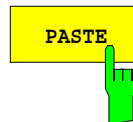

The *PASTE* softkey copies files from the clipboard to the current directory. The directory is changed by means of the cursor keys and subsequent pressing of *ENTER* or via the *EDIT PATH* softkey.

IEC/IEEE-bus command -

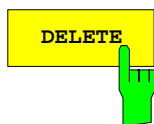

The *DELETE* softkey deletes the selected file.

A confirmation query is displayed to avoid unintentional deletion of files.

IEC/IEEE-bus command `MMEM:DEL "test01.hcp"`
`MMEM:RDIR "D:\user\test"`

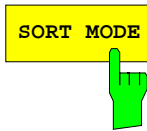

The *SORT MODE* softkey opens the submenu to select the sorting mode for the displayed files.

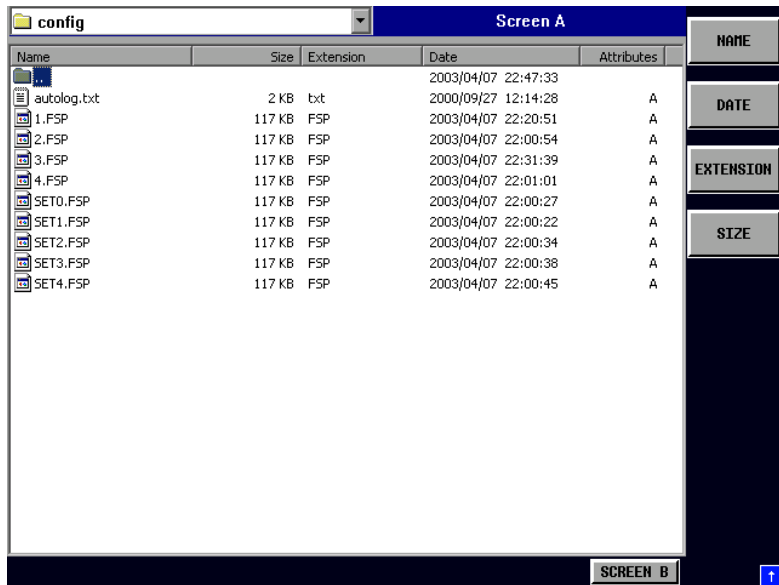

Directory names are located at the top of the list after the entry for the next higher directory level ("..").

IEC/IEEE command: --

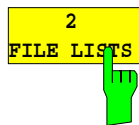

The *2 FILE LISTS* softkey opens a second window for the File Manager. The entry focus can be moved between the two windows by means of hotkeys *SCREEN A* and *SCREEN B*. Files can thus very easily be copied and shifted from one directory to the other.

Note:

The second file list can also be opened in the Full Screen mode via hotkey *SCREEN B* or *SCREEN A*.

IEC/IEEE-bus command -

FILE - NEXT menu:



The *ASCII FILE EXPORT* softkey stores the active trace in ASCII format to a disk.

IEC/IEEE-bus command: FORM ASC;
 MMEM:STOR:TRAC 1, 'TRACE.DAT'

The file consists of a header, which contains important scaling parameters, and a data section, which contains the trace data.

The file header data comes in three columns separated by semicolons (;). It has the following contents:

parameter name; numerical value; default unit

The data section starts with the keyword "Trace <n>", where <n> designates the number of the trace to be stored. This is followed by the measured data in columns separated by semicolons (;).

This format can be read by spreadsheet programs such as MS Excel. A semicolon (;) is to be defined as a separator between the cells of a table.

Note: *Analysis programs may come in different language versions that require different notations of the decimal point. By means of the DECIM SEP softkey, a decimal point (.) or a comma (,) can be selected as decimal-point notation.*

For a detailed description of the ASCII file format, refer to section "Selection and Setting of Traces – TRACE Key", ASCII FILE EXPORT softkey.

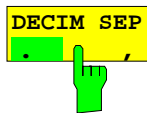

By means of the *DECIM SEP* softkey, one can select between a decimal point (.) and a comma (,) as decimal-point notation for the ASCII FILE EXPORT function.

Due to the possibility of selecting between different decimal-point notations, different language versions of analysis programs (such as MS Excel) can be supported.

IEC/IEEE-bus command: FORM:DEXP:DSEP POIN

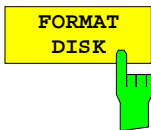

The *FORMAT DISK* softkey formats disks located in drive A:.

To prevent accidental destruction of disk data, confirmation by the user is requested.

IEC/IEEE command: MMEM:INIT "a:"

Measurement Documentation – *HCOPY* Key

Note: The installation of additional printers is described together with the *INSTALL PRINTER* softkey.

HCOPY menu:

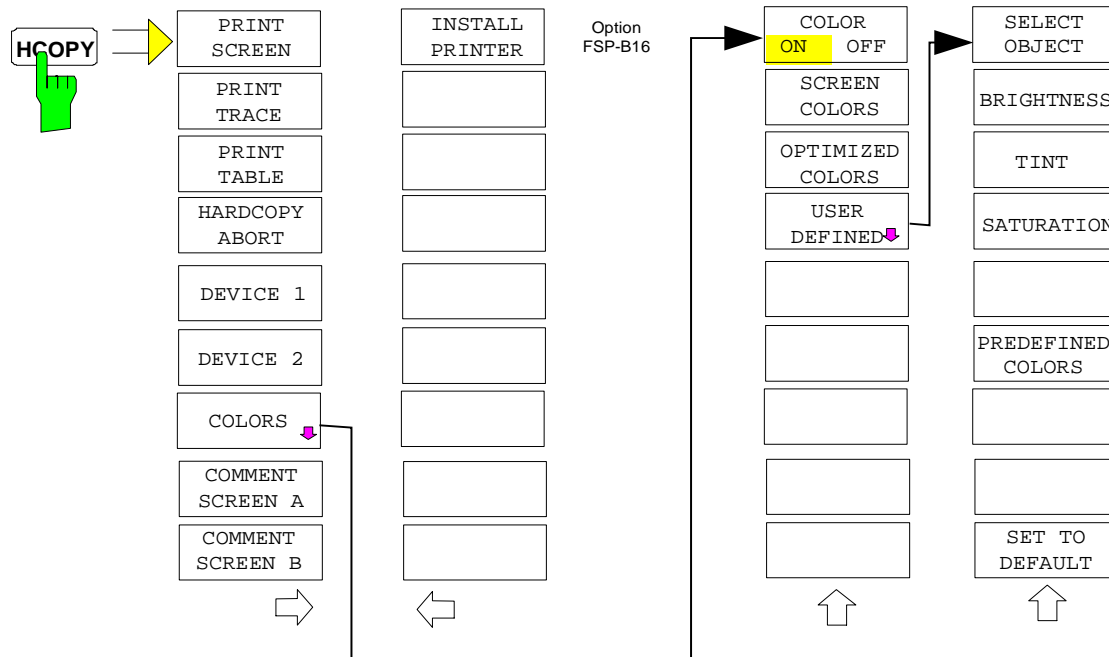

The *HCOPY* key opens the *HARDCOPY* menu for starting and configuring the printout.

Pressing one of the softkeys *PRINT*, *SCREEN*, *PRINT TRACE* or *PRINT TABLE* in the *HCOPY* menu initiates the print job. The printer parameters defined in the *DEVICE SETTINGS* menu are used for setting up the printer configuration. All of the display items to be printed are written to the printer buffer. Since the printer runs in the background, the instrument may be operated immediately after pressing the *PRINT...* softkey.

With *PRINT SCREEN* selected, all the diagrams with traces and status displays are printed as they occur on the screen. Softkeys, open tables and data entry fields are not printed.

The *PRINT TRACE* function allows individual traces to be printed. With *PRINT TABLE*, tables can be printed.

The *DEVICE 1* and *2* softkeys are used for selecting and configuring the output interface.

If the *PRINT TO FILE* option in the *DEVICE SETTINGS* table is selected, the printout is directed to a file. Upon pressing one of the *PRINT...* softkeys, the file name to which the output data is to be written is requested. An entry field is then opened for entering the file name.

The *COLORS* submenu allows switchover between black-and-white and colour printouts (default), provided that the printer connected can produce colour printouts. In addition, the colours are set in this submenu.

- *SCREEN* Output in screen colours.
- *OPTIMIZED* (default) Instead of light colours, dark colours are used for traces and markers: trace 1 blue, trace 1 black, trace 3 green, markers turquoise.
- *USER DEFINED* This option enables the user to change the colours at will. It provides the same setting functions as the *DISPLAY – CONFIG DISPLAY – NEXT* menu.

Notes:

1. With *SCREEN* and *OPTIMIZED* selected, the background will always be white and the grid black. With *USER DEFINED*, these colours can be selected, too.
2. Upon activation of the submenu, the colour display is switched over to the selected printout colours. When the menu is quit, the original colour setting is restored.

The *COMMENT SCREEN A* and *COMMENT SCREEN B* softkeys allow text to be added to the printout (date and time are inserted automatically).

Use the *INSTALL PRINTER* softkey to install additional printer drivers.

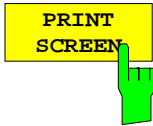

The *PRINT SCREEN* softkey starts the output of test results.

All the diagrams, traces, markers, marker lists, limit lines etc are printed out as long as they are displayed on the screen. All the softkeys, tables and open data entry fields are not printed out. Moreover, comments, title, date, and time are output at the bottom margin of the printout .

IEC/IEEE-bus command: `HCOP:ITEM:ALL`
`HCOP:IMM`

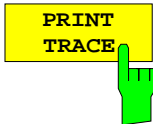

The *PRINT TRACE* softkey starts the output of all curves visible on the display screen without auxiliary information. Specifically, no markers or display lines are printed.

IEC/IEEE-bus command: `HCOP:ITEM:WIND:TRAC:STAT ON`
`HCOP:IMM`

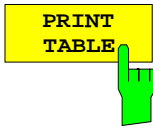

The *PRINT TABLE* softkey starts the output of all tables and info lists visible on the display screen without the measurement diagrams and other information lying behind.

IEC/IEEE-bus command: `HCOP:ITEM:WIND:TABL:STAT ON`
`HCOP:IMM`

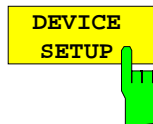

The *DEVICE SETUP* softkey opens the dialog where the file format and the printer can be selected (see section "Selecting Printer, Clipboard and File Formats").

IEC/IEEE-bus commands: `HCOP:DEV:LANG GDI;`
`SYST:COMM:PRIN:ENUM:FIRS?;`
`SYST:COMM:PRIN:ENUM:NEXT?;`
`SYST:COMM:PRIN:SEL <Printer>;`
`HCOP:PAGE:ORI PORT;`
`HCOP:DEST "SYST:COMM:PRIN";`
`HCOP:DEST "SYST:COMM:M MEM"`

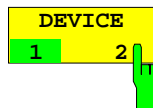

The analyzer is able to manage two hardcopy settings independently of each other. They are selected via the *DEVICE 1 / 2* softkey, which displays also the associated setting if the *DEVICE SETUP* dialog is open.

IEC/IEEE-bus command: `--`

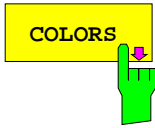

The *COLORS* softkey gives access to the submenu where the colours for the printout can be selected (see section "*Selecting Printer Colours*").

IEC/IEEE-bus command: -

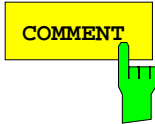

The *COMMENT* softkey opens an entry field in which a comment of two lines (60 characters per line) can be entered for screen A or B.

If the user enters more than 60 characters, the excess characters appear on the second line on the print-out. At any point, a manual line-feed can be forced by entering the @ character.

The comment is printed below the diagram area. The comment text appears on the hardcopy, but not on the display screen.

If a comment should not be printed, it must be cleared.

If the instrument is reset by a click on the PRESET key, all entered comments are cleared.

Note:

The COMMENT softkey opens the auxiliary line editor where the desired letters can be entered in the text field by means of spinwheel and cursor keys.

After clicking the *COMMENT* softkey, the auxiliary line editor can be reached with the  key. Pressing the spinwheel or the *ENTER* key inserts the selected characters in the text line.

After editing is completed, return to the text line with the  key and confirm the comment text with *ENTER*.

If the entered comment should be aborted, quit the auxiliary line editor with *ESC*.

Important:

Only after the auxiliary line editor has been closed with *ESC* can the softkeys and hardkeys be operated again.

A detailed description of the auxiliary line editor can be found in section "Entering a Text with the Auxiliary Line Editor".

IEC/IEEE-bus command: `HCOP:ITEM:WIND2:TEXT 'Comment'`

HCOPY NEXT menu:



A certain number of printer drivers is already installed on the FSP.

The *INSTALL PRINTER* softkey opens the *Printers and Faxes* dialog where more printer drivers can be installed.

For details refer to sections "Installation of Plug&Play Printers" and "Installation of Non-Plug&Play Printers".

IEC/IEC-bus command: -

Selecting Printer, Clipboard and File Formats

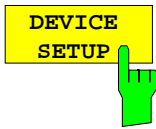

The *DEVICE SETUP* softkey opens the selection dialog for file format and printer.

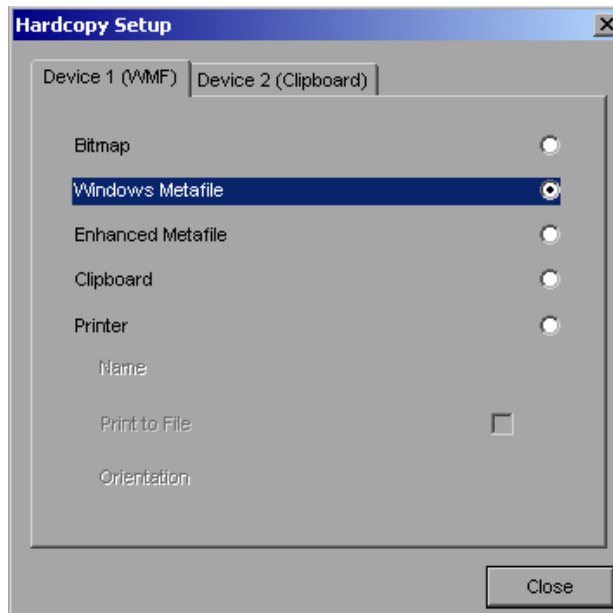

Navigation in the dialog is possible by turning the spinwheel; selection of an item is confirmed by pressing the spinwheel or the *ENTER* key.

The dialog is closed with *ESC* (alternatively, the *Close* button can be selected with the spinwheel and the dialog can be closed by pressing the spinwheel or with *ENTER*).

File formats

A file format is selected by turning the spinwheel and then confirmed by pressing the spinwheel or the *ENTER* key.

The following file formats can be selected:

BITMAP	BMP format (non-compressed)
WINDOWS METAFILE	Vector format, supported as of Windows 3.1
ENHANCED METAFILE	Vector format, supported as of Windows 95/98/ME/NT/XP

When a file format is selected, printing to a file is automatic. The file name is queried when the *PRINT SCREEN*, *PRINT TRACE* and *PRINT TABLE* softkeys are pressed.

Clipboard

A clipboard is also selected with the spinwheel and then confirmed by pressing the spinwheel or *ENTER* key.

After the *PRINT SCREEN*, *PRINT TRACE* or *PRINT TABLE* softkey has been pressed, printout is routed to the clipboard. With the aid of the "Process - Insert" function, the information in the clipboard can then be pasted into other programs, e.g. *Paint*, and subsequently processed.

Printer

A printer (also a preconfigured network printer) is selected by selecting *Printer* with the spinwheel and then confirmed by pressing the spinwheel or the *ENTER* key.

After confirmation, the entries under *Name*, *Print to File* and *Orientation* are available for selection with the spinwheel.

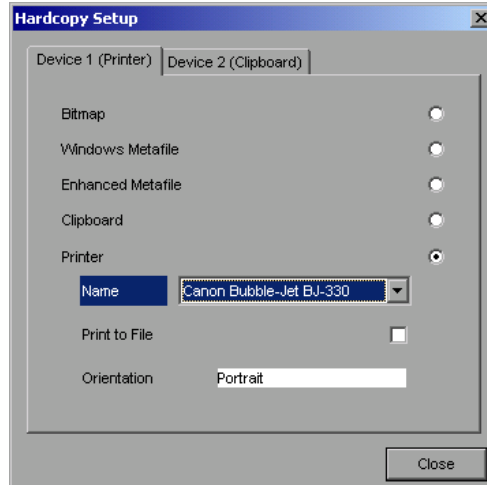

To select the printer type, select *Name* and open the selection list by pressing the spinwheel or *ENTER*.

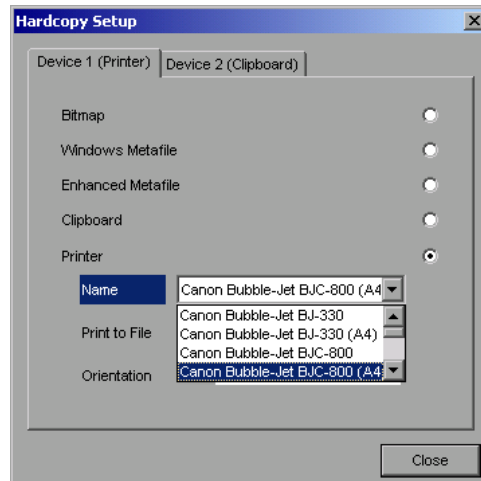

Select the desired printer (in the example "Cannon Bubble-Jet BJC800 (A4)") from the list by means of the spinwheel and confirm by pressing the spinwheel or *ENTER*. This closes the list and the cursor is placed on the *Name* field again.

Printing to a file is also possible. In this case select *Print to File* with the spinwheel and activate or deactivate the associated list by pressing the spinwheel or the *ENTER* key.

The printing format is selected under *Orientation*. In this case, too, pressing the spinwheel or *ENTER* opens the selection list.

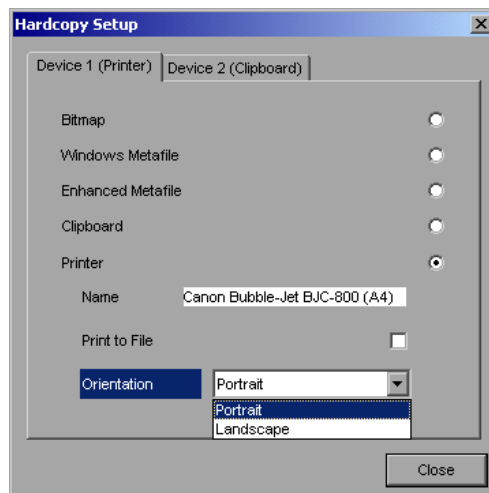

The desired format (here *Portrait*) is selected in the list with the spinwheel and confirmed by pressing the spinwheel or *ENTER*. This closes the list and the cursor is placed again on the *Orientation* field.

The dialog is then closed with *ESC* or by clicking the *Close* button.

Note: The installation of new printer types is described in sections "Local Printer" and "Configuring a Network Printer"

Selecting Alternative Printer Configurations

The analyzer is capable of managing two independent hardcopy settings. This, for instance, permits fast switchover between printing to a file or by a printer.

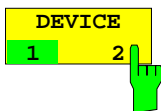

A selection is made with the *DEVICE 1 / 2* softkey which also shows settings when the *DEVICE SETUP* dialog is open.

IEC/IEEE-bus command: --

Selecting Printer Colours

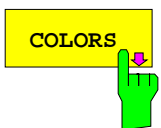

The *COLORS* softkey gives access to the submenu where the colours for the printout can be selected. To facilitate colour selection, the selected colour combination is displayed when the menu is entered. The previous colours are restored when the menu is exited.

IEC/IEEE-bus command: -

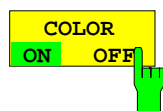

The *COLOR ON OFF* softkey switches over from colour output to black-and-white output. All colour-highlighted areas are printed in white and all colour lines in black. This improves the contrast on the printout. The default setting is *COLOR ON*.

IEC/IEEE-bus command: HCOP : DEV : COL ON

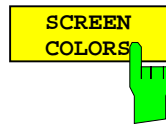

The *SCREEN COLORS* softkey selects the current screen colours for the printout.

Note: *The background is always printed in white and the grid in black.*

IEC/IEEE-bus command: HCOP : CMAP : DEF1

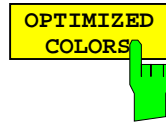

The *OPTIMIZED COLORS* softkey selects an optimized colour setting for the printout to improve the visibility of the colours on the hardcopy.

Trace 1 is blue, trace 2 black, trace 3 green, and the markers are turquoise.

The other colours correspond to the display colours of the *DISP – CONFIG DISPLAY -DEFAULT COLORS 1* softkey.

Note: *The background is always printed in white and the grid in black.*

IEC/IEEE-bus command: HCOP : CMAP : DEF2

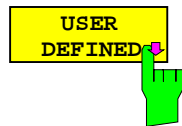

The *USER DEFINED* softkey opens a submenu for user-defined colour selection (see submenu *USER DEFINED COLORS*).

IEC/IEEE-bus command: HCOP : CMAP : DEF3

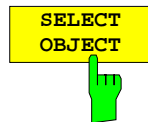

The *SELECT OBJECT* softkey allows picture elements to be selected to change their colour setting. After selection, the *PREDEFINED COLORS*, *BRIGHTNESS*, *TINT* and *SATURATION* softkeys enable the user to change the colours or brightness, the hue and the colour saturation of the element selected.

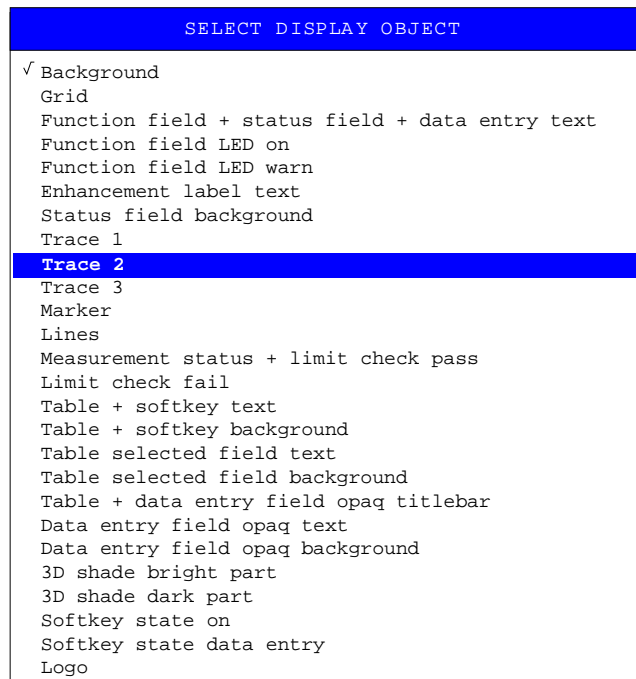

IEC/IEEE-bus command: -



The *BRIGHTNESS* softkey serves for determining the brightness of the graphic element selected.

A value between 0 and 100% can be entered.

IEC/IEEE-bus command:

```
HCOP:CMAP5:HSL <hue>,<sat>,<lum>
```

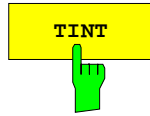

The *TINT* softkey serves for determining the hue of the element selected. The percentage entered refers to a continuous colour spectrum from red (0%) to blue (100%).

IEC/IEEE-bus command:

```
HCOP:CMAP5:HSL <hue>,<sat>,<lum>
```



The *SATURATION* softkey serves for determining the saturation of the element selected.

A value between 0 and 100% can be entered.

IEC/IEEE-bus command:

```
HCOP:CMAP5:HSL <hue>,<sat>,<lum>
```



The *PREDEFINED COLORS* softkey opens a list from which predefined colours for the displayed elements can be selected:

COLOR	
√	BLACK
	BLUE
	BROWN
	GREEN
	CYAN
	RED
	MAGENTA
YELLOW	
	WHITE
	GRAY
	LIGHT GRAY
	LIGHT BLUE
	LIGHT GREEN
	LIGHT CYAN
	LIGHT RED
	LIGHT MAGENTA

IEC/IEEE-bus command:

```
HCOP:CMAP1 ... 26:PDEF <color>
```

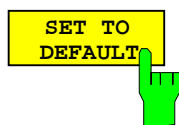

The *SET TO DEFAULT* softkey reactivates the default colour setting (= *OPTIMIZED COLORS*).

IEC/IEEE-bus command: -

Entering a Text with the Auxiliary Line Editor





The auxiliary line editor is opened automatically when the *COMMENT* softkey is clicked.



The entry area consists of two parts:

- the editing line
- the character selection field

Changeover from the editing line to the character selection is performed with the *cursor down*  key.

Navigation in the character selection field is possible with the spinwheel or the cursor keys , ,  and .

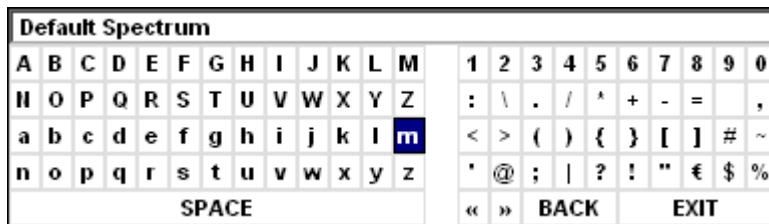

Pressing the spinwheel or the *ENTER* key transfers the desired characters to the editing line.



The fields in the last line of the character selection field are assigned special functions.

- SPACE inserts a space in the editing line
 << shifts the cursor in the editing line by one character to the left
 >> shifts the cursor in the editing line by one character to the right
 BACK clears the character before the cursor
 EXIT stores the content of the editing line and closes the auxiliary line editor

Return to the editing line from the first line of the character selection field using the *cursor up*  key.

Navigation within the editing line is also performed with the spinwheel or the cursor keys  and .

Figures, decimal points and signs are directly entered in the editing line using the keypad on the front panel. When a PC keyboard is connected, letters and special characters can also be directly entered.

Editing is terminated from the editing line with *ENTER* if the text should be stored, and with *ESC* when the entered text should be aborted. In both cases the auxiliary line editor is closed.

Installation of Plug&Play Printers

The installation of Plug&Play printers under Windows XP is quite simple:

After the printer is connected and switched on, Windows XP automatically recognizes it and installs its driver, provided the driver is included in the XP installation.

If the XP printer driver is not found, Windows XP prompts you to enter the path for the corresponding installation files. In addition to pre-installed drivers, a number of other printer drivers can be found in directory D:\I386.

Note: When installing new printer drivers, you will be prompted to indicate the path of the new driver. This path may be on a disk in drive A. Alternatively, the driver can be loaded via a memory stick or USB CD-ROM drive (see section "Connection of USB Devices").

Installation of Non-Plug&Play Printers

Note: The dialogs below can be operated either from the front panel or via mouse and keyboard (see sections "Connecting a Mouse" and "Connecting a Keyboard"). *Mouse and PC keyboard are absolutely essential for configuring network printers.*

A new printer is installed via the *INSTALL PRINTER* softkey.

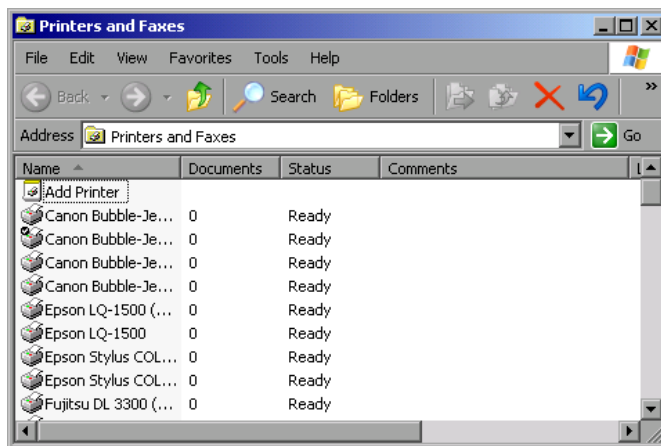

- Select *Add Printer* in the list using the spinwheel.
- Highlight the selected item with *CURSOR RIGHT* and press *ENTER* or the spinwheel to confirm the selection.

The *Add Printer Wizard* is displayed.

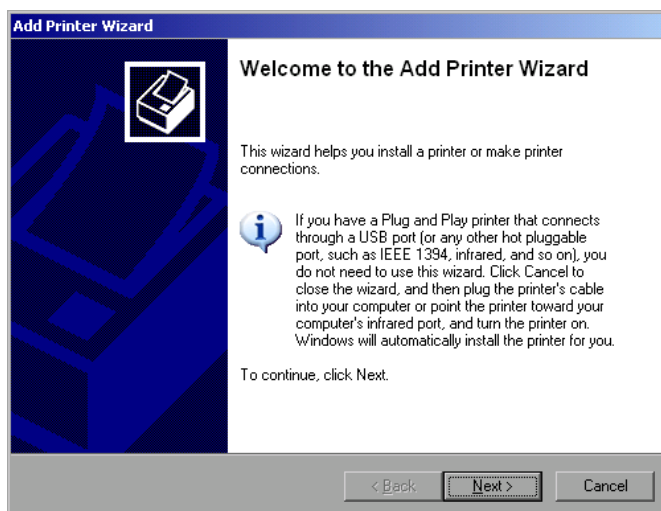

- Select *NEXT* with the spinwheel and press the spinwheel for confirmation.

Local or Network Printer can be selected.

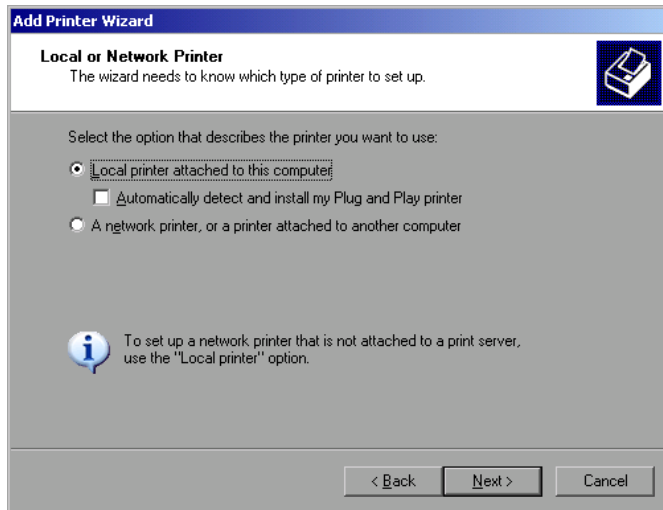

- To install a local printer, select *Local printer attached to this computer* with the spinwheel. Press the spinwheel for confirmation and continue with the "Local Printer" section.
- To install a network printer, select *A network printer, or a printer attached to another computer*. Press the spinwheel for confirmation and continue with the "Network Printer" section.

Local Printer

In the example below, a Star LC24 printer is installed.

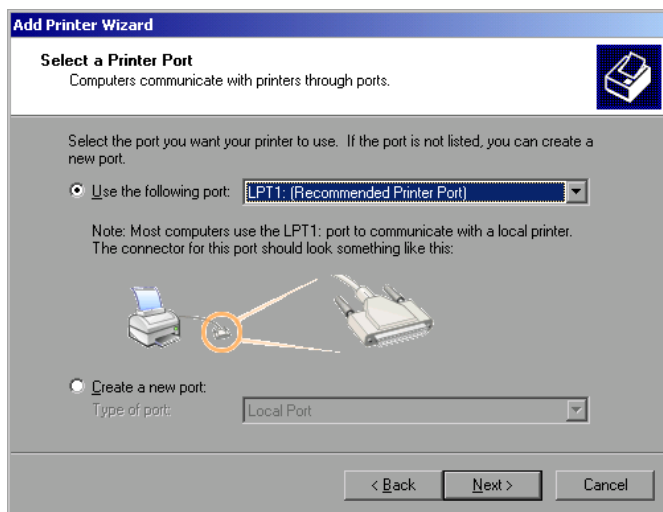

- To select the USB interface, open the list of ports by clicking the spinwheel. Select the printer port with spinwheel/arrow keys and confirm by pressing the spinwheel. The selection list is closed again.
 - To select the LPT connector, the selection list need not be opened.
 - Place the cursor on the *Next* button and confirm by pressing the spinwheel.
- The "Install Printer Software" dialog is opened.

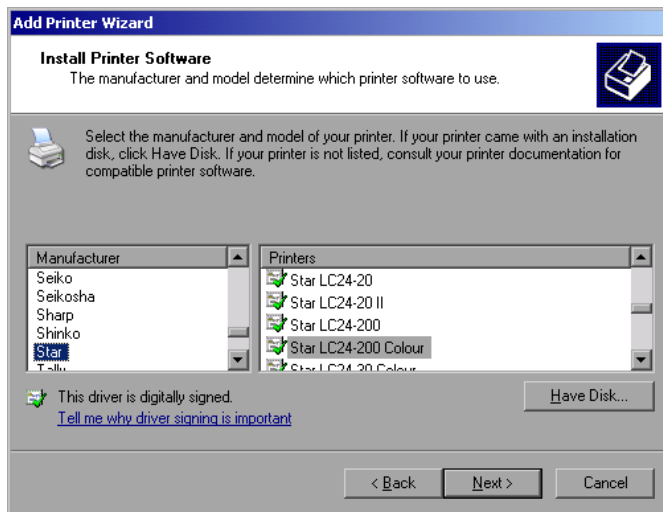

- Select the desired manufacturer ("Star") in the Manufacturer table using the up / down keys.

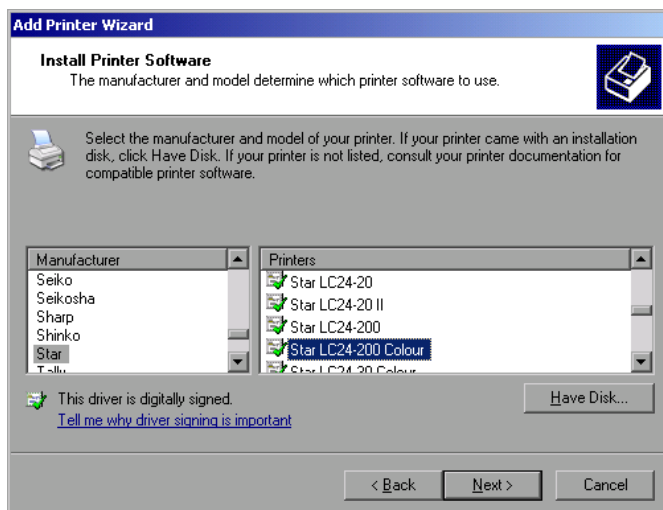

Go to the *Printers* list with the spinwheel.

- Select the desired printer type (Star LC24-200 Colour) using the up / down keys and confirm with *ENTER*.

Note:

If the desired printer type is not in the list, the respective driver is not installed yet. In this case click the HAVE DISK button with the mouse key. You will be prompted to insert a disk with the corresponding printer driver. Press OK and select the desired printer driver.

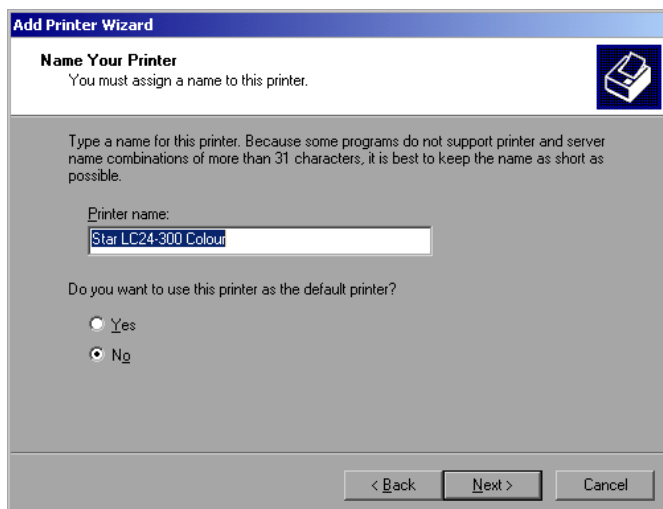

The printer name can be changed as required in the *Printer name* entry field (max. 60 characters). A PC keyboard is required in this case.

- Use the spinwheel to select *Yes or No* for the default printer.
- Choose the desired status with the up /down keys.
- Confirm with *ENTER*.

The *Printer Sharing* dialog is opened.

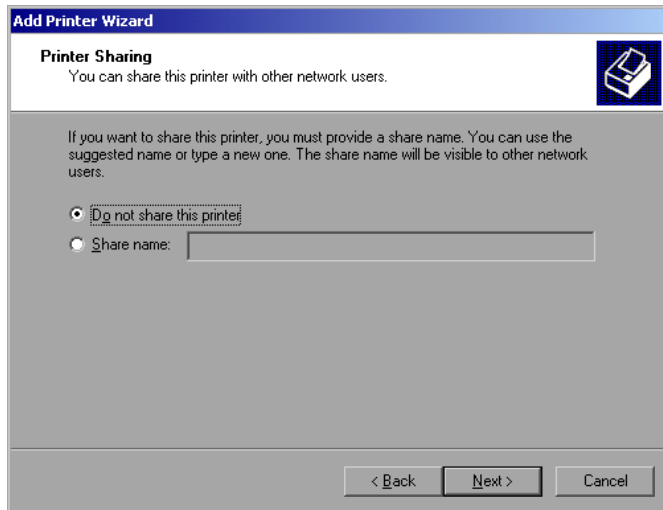

- Exit the dialog with *ENTER*.
The *Print Test Page* dialog is opened.

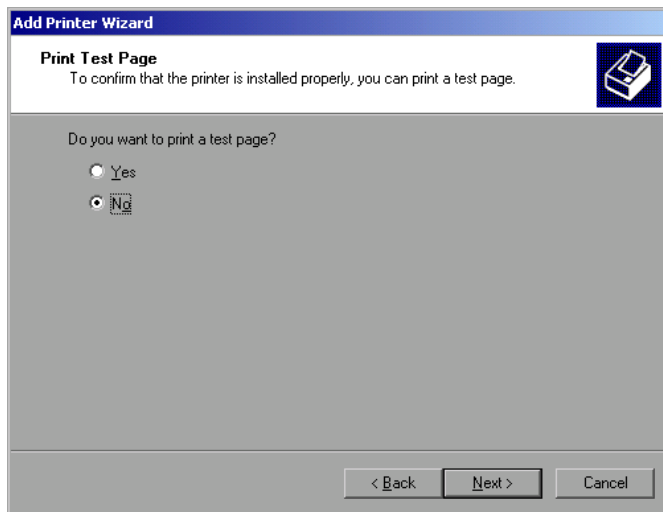

- Exit the dialog with *ENTER*.
The *Completing the Add Printer Wizard* dialog is opened.

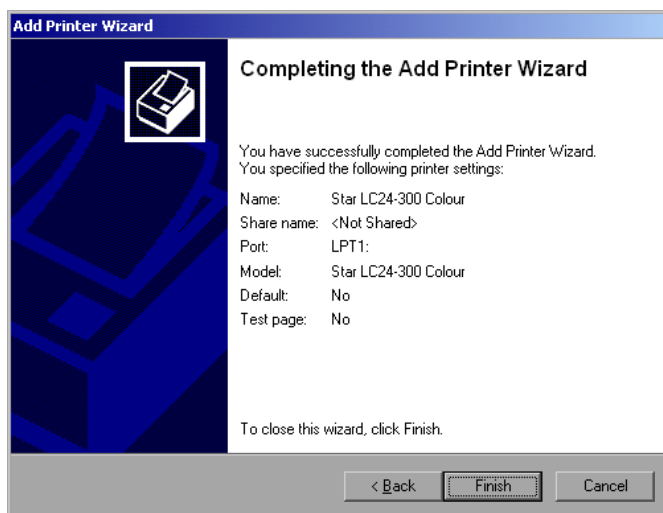

- Check the displayed settings and exit the dialog with *ENTER*.

The printer is installed. If Windows finds the required driver files, the installation is completed without any further queries.

If Windows cannot find the required driver files, a dialog is opened where the path for the files can be entered.

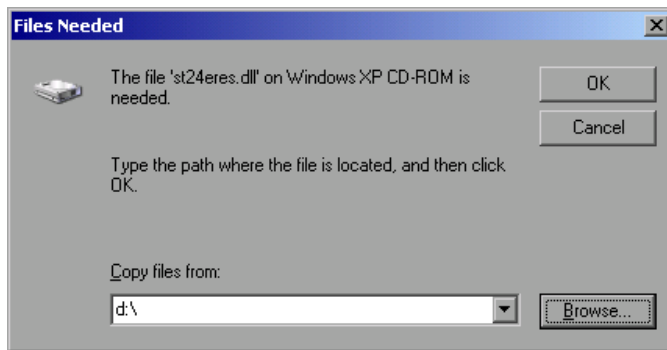

- Select the *Browse* button with the spinwheel and confirm with by pressing the spinwheel.

The *Locate File* dialog is opened.

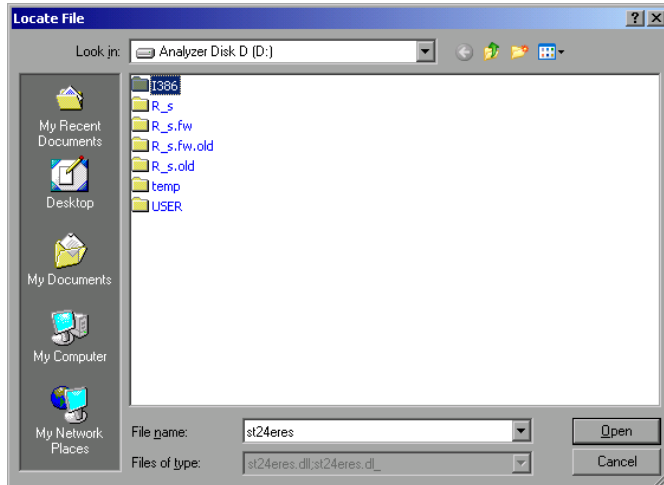

- Turn the spinwheel to select the directory and path D:\I386 and press it to confirm the selection.

If the selected item is not printed on a blue background, it must be marked with the cursor up / down keys before it can be activated by pressing the spinwheel.

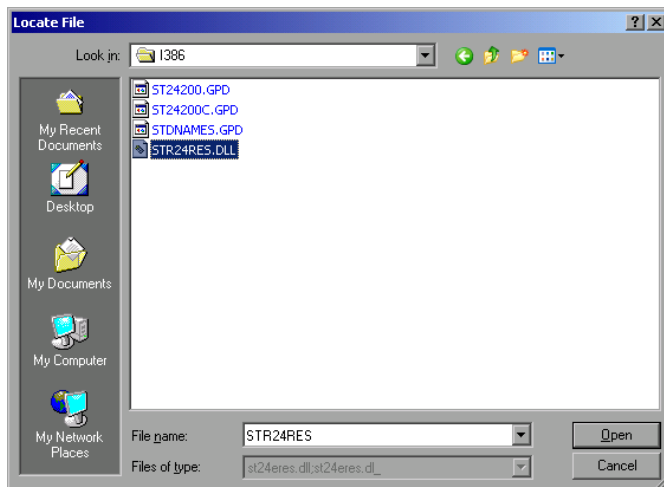

- Select the driver file with the spinwheel and confirm by pressing the spinwheel.

The file is included in the *Files Needed* dialog.

Note:

If the desired file is not in the D:\I386 directory, a disk with the driver file is needed. In this case, exit the dialog with ESC and repeat the selection starting from the "Files needed" dialog.

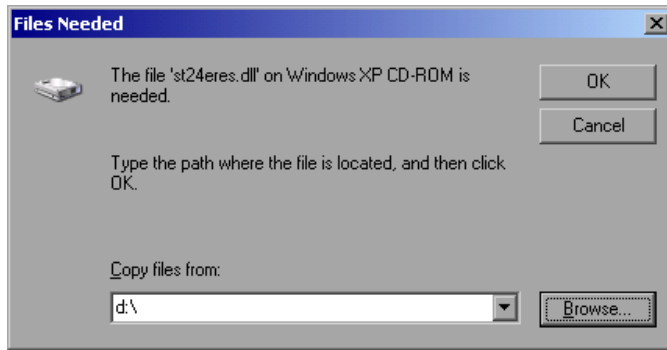

- Select the OK button with the spinwheel and press the spinwheel to confirm.

The installation is completed.

Finally the instrument must be configured for printouts of the measurement screen with this printer. For details please refer to the *DEVICE SETUP* softkey in the hardcopy menu.

Network Printer

Note: *For easy operation of the subsequent dialogs, connection of a PS/2 keyboard with trackball to the front panel is recommended. If no trackball is available, a USB mouse should be connected additionally to the rear panel (see section "Connecting a Mouse" and "Connecting a Keyboard")*

In the example below, a HP Laserjet 5 printer is installed as network printer. The Add Printer Wizard has already been opened as described in section " Starting the Add Printer Wizard "

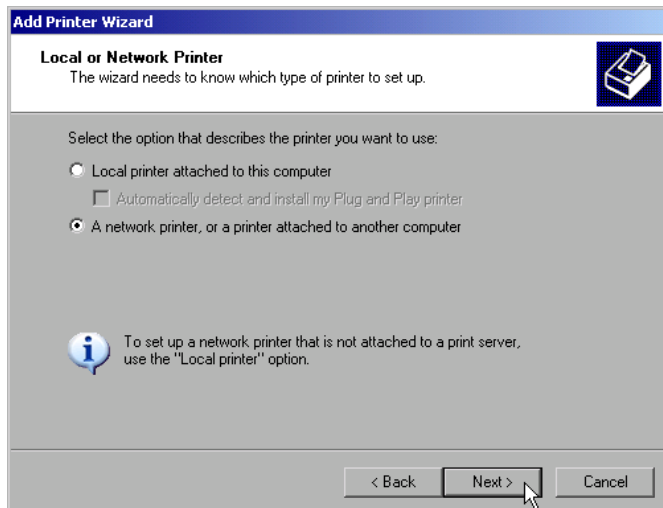

- To select a network printer, click the option "A network printer or a printer attached to another computer".

Continue with *Next*.

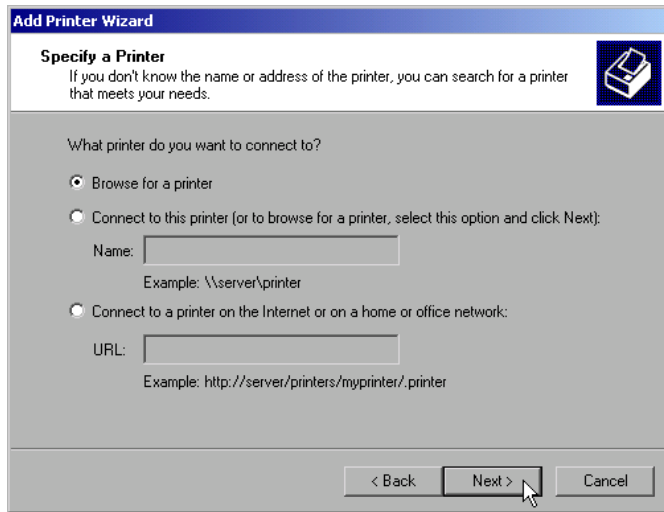

- Click *Browse for a printer* and then *Next*.
A list of selectable printers is displayed.

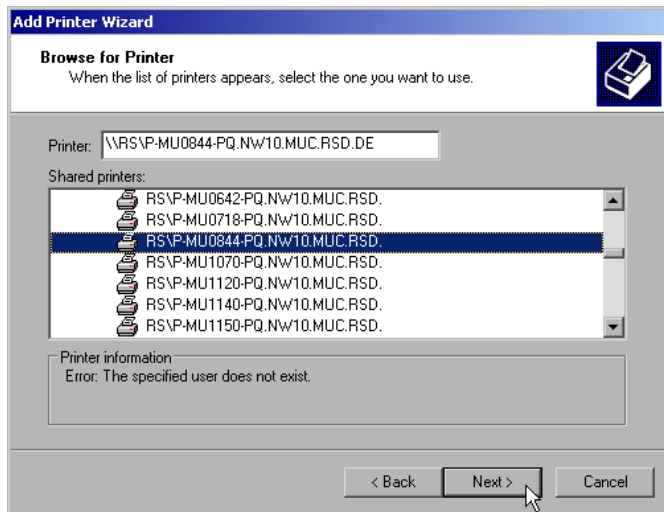

- Mark the desired printer and select it with *OK*.

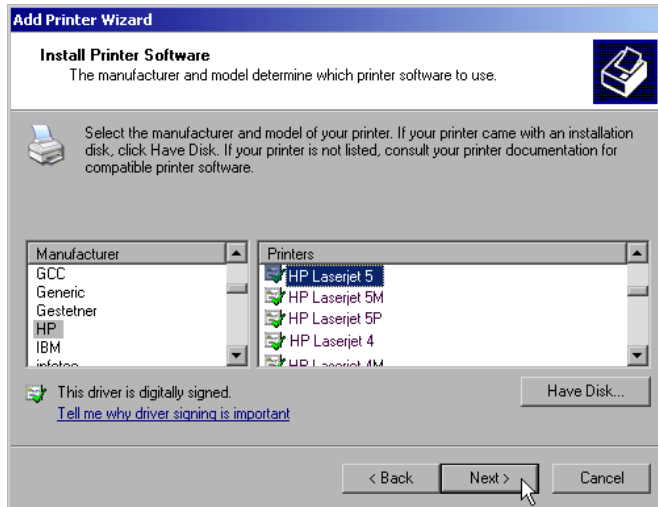

➤ Confirm the subsequent prompt to install a suitable printer driver with "OK". The list of available printer drivers is displayed.

The manufacturers are listed in the left-hand table, the available printer drivers in the right-hand table.

➤ Select the manufacturer from the *Manufacturers* table and then the printer driver from the *Printers* table.

Note:

If the desired type of output device is not shown in the list, the driver has not yet been installed. In this case, click the "HAVE DISK" button. You will be prompted to insert a disk with the corresponding printer driver. Insert the disk, select "OK" and then choose the desired printer driver.

➤ Click *Next*.

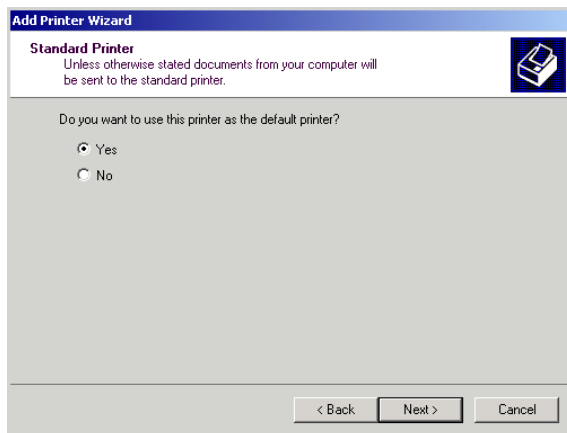

If one or more printers are already installed, a query is displayed whether the printer just installed should be used as the standard printer for the Windows XP applications. Default setting is *No*.

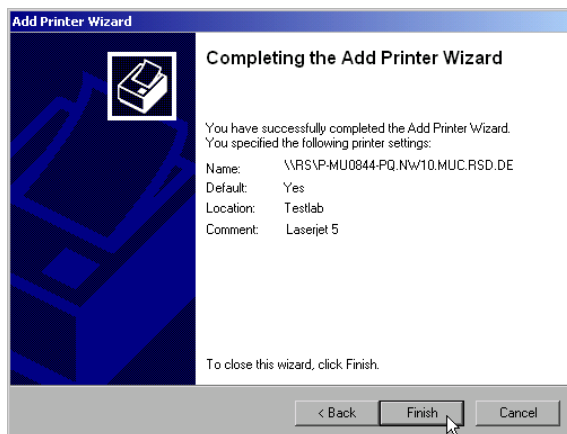

➤ Start the printer driver installation with *Finish*.

Finally, the instrument has to be configured for printout with this printer using the DEVICE SETUP and DEVICE 1/2 softkeys in the hardcopy main menu (see section "Selection of a Printer").

Tracking Generator - Option FSP-B9

During normal operation (without a frequency offset), the tracking generator emits a signal exactly at the input frequency of the FSP.

For frequency-converting measurements it is possible to set a constant frequency offset of ± 150 MHz between the receive frequency of the FSP and the output signal of the tracking generator. Moreover, an I/Q modulation or AM and FM modulation of the output signal can be provided using two analog input signals.

The output power is level-controlled and can be set in 0.1 dB steps in a range from -30 dBm to 0 dBm.

The tracking generator can be used in all operating modes. Acquisition of test setup calibration values (SOURCE CAL) and normalization using these correction values (*NORMALIZE*) is only possible in the *NETWORK* operating mode.

Note: *The RF characteristics of some DUTs is especially sensitive concerning the input VSWR. In such cases insertion of 20 dB attenuation between the DUT and the tracking generator output is highly recommended.*

The tracking generator is activated by means of the NETWORK hotkey in the hotkey bar at the bottom of the screen:



Tracking Generator Settings

The *NETWORK* hotkey opens a menu for selecting the functions of the tracking generator.

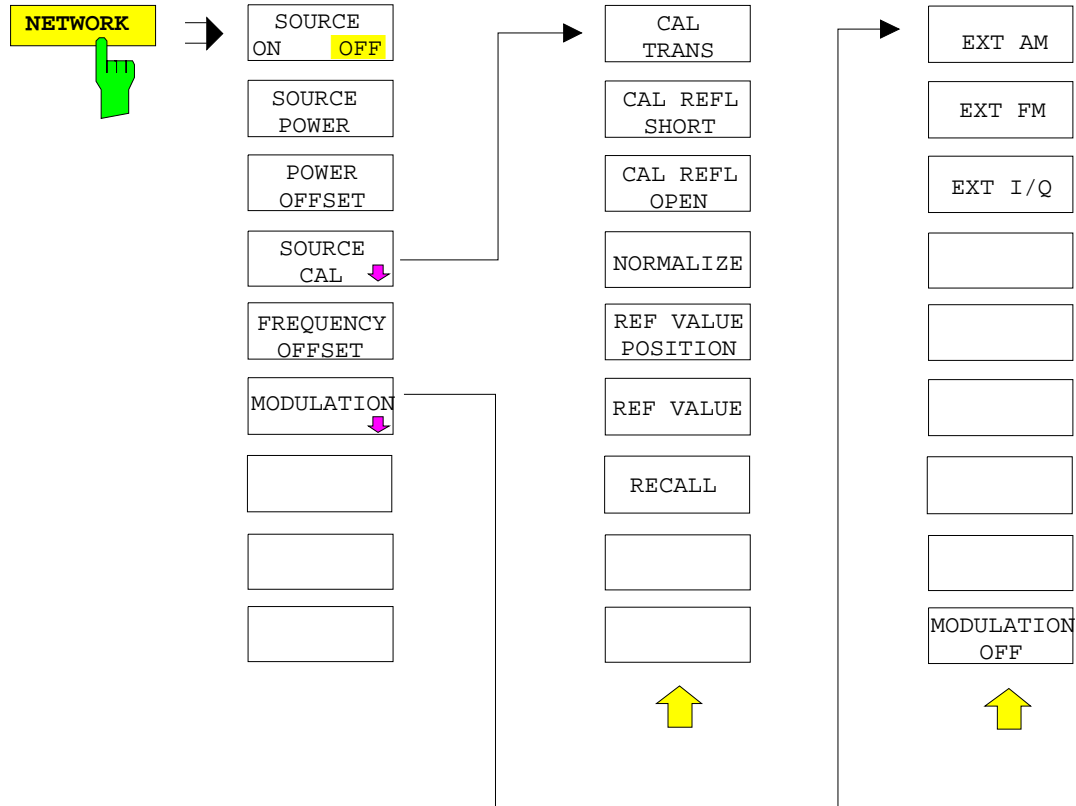

Note: Additional softkeys are available in the displayed menus for controlling an external generator if option External Generator Control FSP-B10 is fitted. For detailed information see section 'External Generator Control Option FSP-B10'.

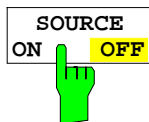

The *SOURCE ON/OFF* softkey switches the tracking generator on or off. Default setting is *OFF*

Note:

- When the tracking generator is switched on the maximum stop frequency is limited to 3 GHz. This upper limit is automatically reduced by a frequency offset set up for the tracking generator.
- In order to meet the data sheet accuracy for measurements with active tracing generator the start frequency must be set to $\geq 3 \times$ Resolution Bandwidth.
- The minimum sweeptime for measurements with data sheet accuracy is 100 ms in frequency domain (span > 0 Hz). Selecting a sweeptime below this limit will result in the sweeptime indicator field SWT being supplied with a red asterisc and the message UNCAL being displayed.
- FFT filters (FILTER TYPE FFT in BW menu) are not available when the tracking generator is active.

IEC/IEEE-bus command: OUTP:STAT ON

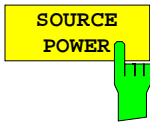

The *SOURCE POWER* softkey allows the tracking generator output power to be selected.

The output power can be set in 0.1 dB steps from -30 dBm to 0 dBm.

If the tracking generator is off, it is automatically switched on when an output power value is entered.

The default output power is -20 dBm.

IEC/IEEE-bus command: `SOUR:POW -20dBm`

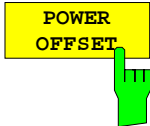

The *POWER OFFSET* softkey allows selection of a constant level offset for the tracking generator.

With this offset for example attenuators or amplifiers at the output connector of the tracking generator can be taken into account for the displayed output power values on screen or during data entry.

The valid range is -200 dB to +200 dB in 0.1 dB steps. Positive offsets apply to an amplifier and negative offsets to an attenuator subsequent to the tracking generator.

The default setting is 0 dB. Offsets \neq 0 will display the enhancement label **LVL**.

IEC/IEEE-bus command: `SOUR:POW:OFFS -10dB`

Transmission Measurement

This measurement will yield the transmission characteristics of a two-port network. The built-in tracking generator serves as a signal source. It is connected to the input connector of the DUT. The input of the FSP is fed from the output of the DUT.

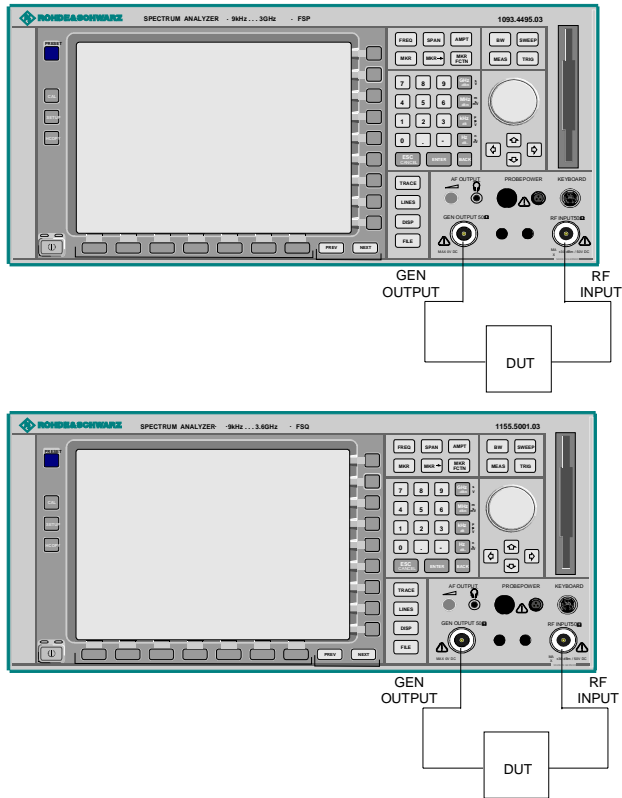
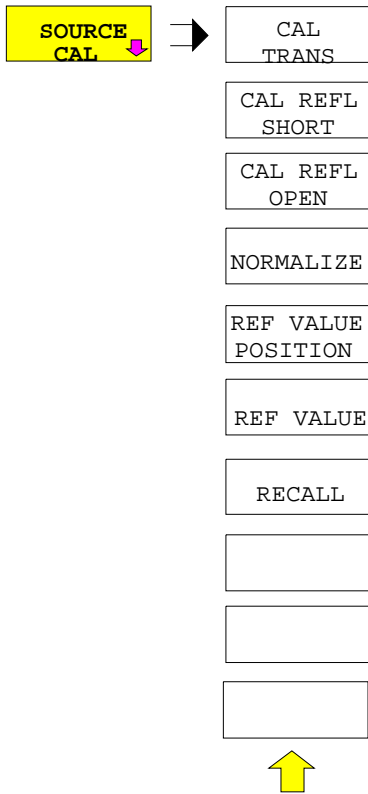

Fig. 4.21-1 Test setup for transmission measurement

A calibration can be carried out to compensate for the effects of the test setup (eg frequency response of connecting cables).

Calibration of Transmission Measurement

NETWORK menu:



The *SOURCE CAL* softkey opens a submenu comprising of the calibration functions for the transmission and reflection measurement.

The calibration of the reflection measurement (*CAL REFL...*) and its mechanisms are described in separate sections.

To carry out a calibration for transmission measurements the whole test setup is through-connected (THRU).

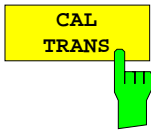

The *CAL TRANS* softkey triggers the calibration of the transmission measurement.

It starts a sweep that records a reference trace. This trace is then used to calculate the difference for the normalized values.

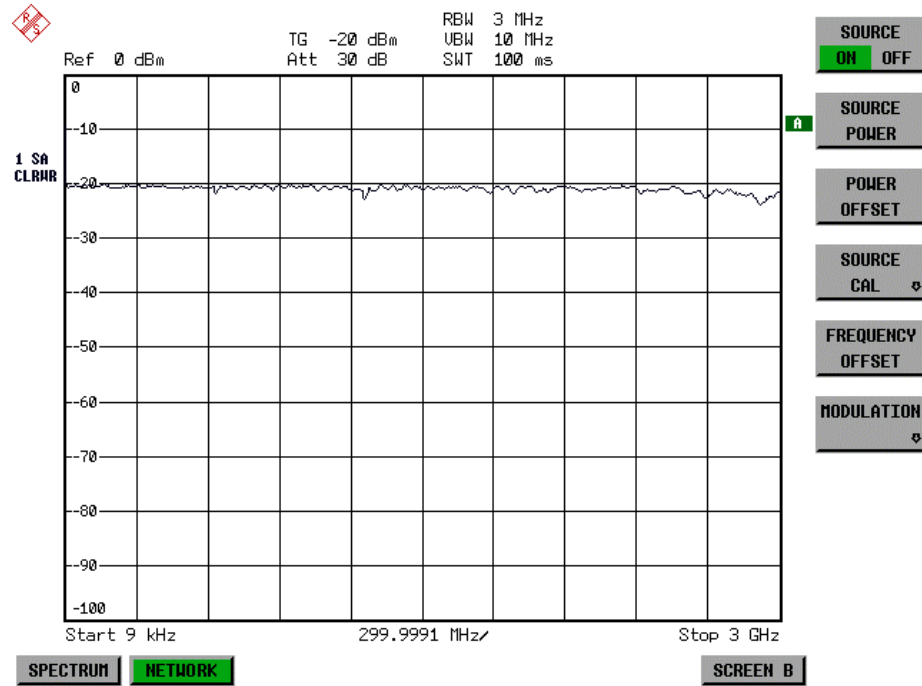
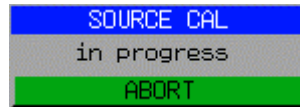
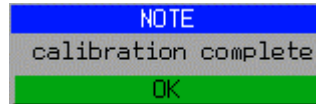

Fig. 4.21-2 Calibration curve for transmission measurement

During the calibration the following message is displayed:



After the calibration the following message is displayed:



This message will be cleared automatically after approx. 3 seconds.

IEC/IEEE-bus command: CORR:METH TRAN

Normalization

NETWORK-SOURCE CAL menu:

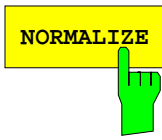

The *NORMALIZE* softkey switches the normalization on or off. The softkey is only available if the memory contains a correction trace.

It is possible to shift the relative reference point within the grid using the *REF VALUE POSITION* softkey. Thus, the trace can be shifted from the upper border of the grid to the vertical center of the grid:

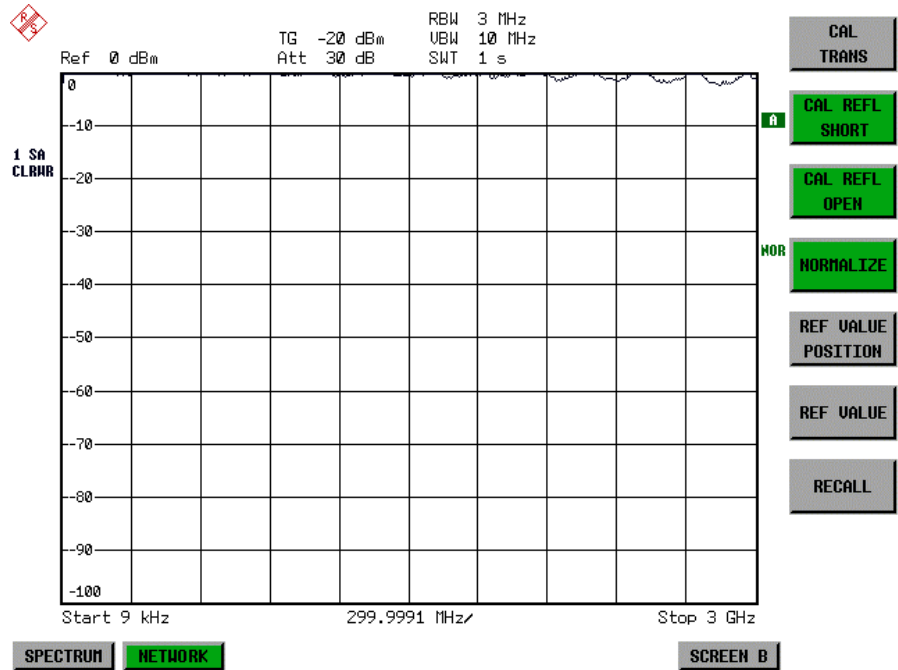

Fig. 4.21-3 Normalized display

In *SPLIT SCREEN* operation, the normalization is switched on in the currently active window. Different types of normalization can be active in the two windows.

Normalization is aborted when the *NETWORK* operating mode is quit.

IEC/IEEE-bus command: CORR ON



The *REF VALUE POSITION* softkey marks a reference position in the active window at which the normalization result (calculated difference with a reference trace) is displayed.

If no reference line is active, the softkey switches on a reference line and activates the input of its position. The line can be moved within the grid boundaries.

The reference line is switched off by pressing the softkey again.

The function of the reference line is explained in the section "Calibration mechanisms".

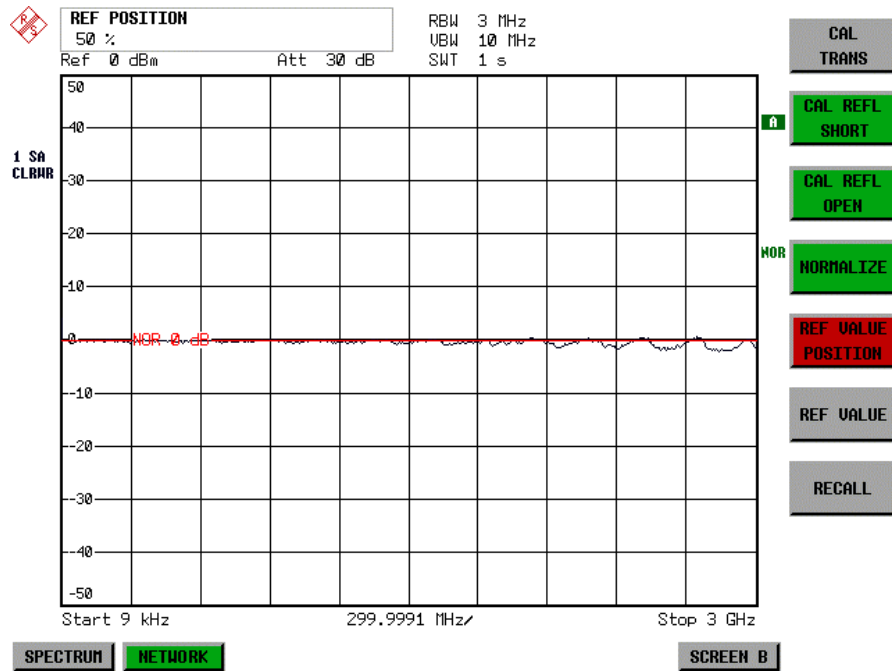
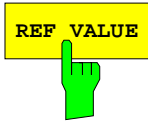

Fig. 4.21-4 Normalized measurement, shifted with *REF VALUE POSITION* 50 %

IEC/IEEE-bus command: DISP:WIND:TRAC:Y:RPOS 10PCT



The *REF VALUE* softkey activates the input of a value which is assigned to the reference line.

With default settings the reference line corresponds to a difference of 0 dB between the currently measured trace and the reference trace. Setting the *REF VALUE* to a different value helps to compensate for changes to the level conditions in the signal path after the calibration data have been recorded. If eg after a source calibration a 10 dB attenuation is inserted into the signal path between DUT and FSP input, the measurement trace will be moved by 10 dB down. Entering a *REF VALUE* of -10 dB will then result in the reference line for difference calculation being moved by 10 dB down as well. This means that the measured trace will be placed on it, as displayed in figure 4-20.

REF VALUE always refers to the active window.

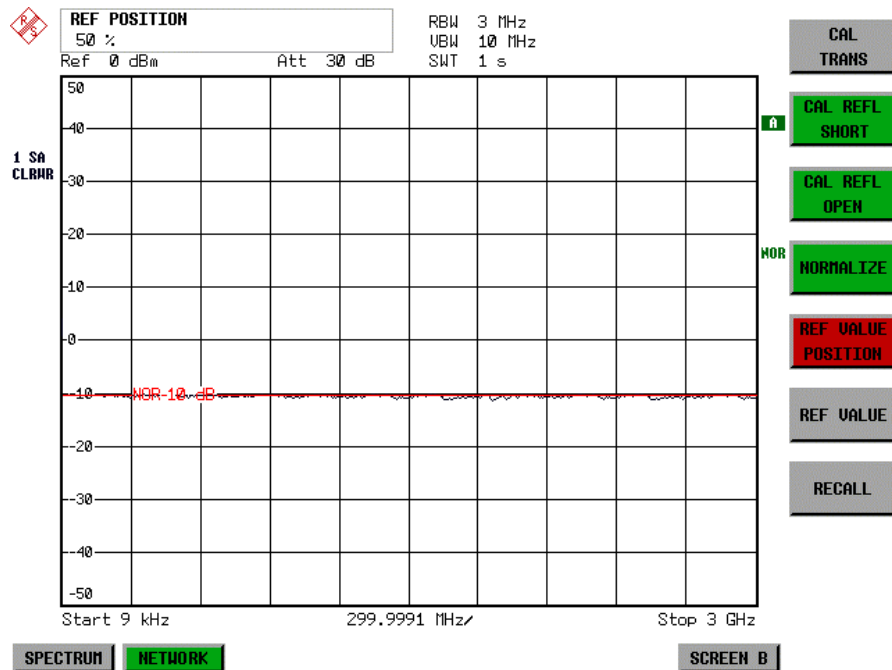

Fig. 4.21-5 Measurement with REF VALUE -10 dB and REF VALUE POSITION 50%

After the reference line has been moved by entering a *REF VALUE* of -10 dB the deviation from the nominal power level can be displayed with high resolution (eg 1 dB/div). The power is still displayed in absolute values, which means that in the above example 1 dB below the nominal power (reference line) = 11 dB attenuation.

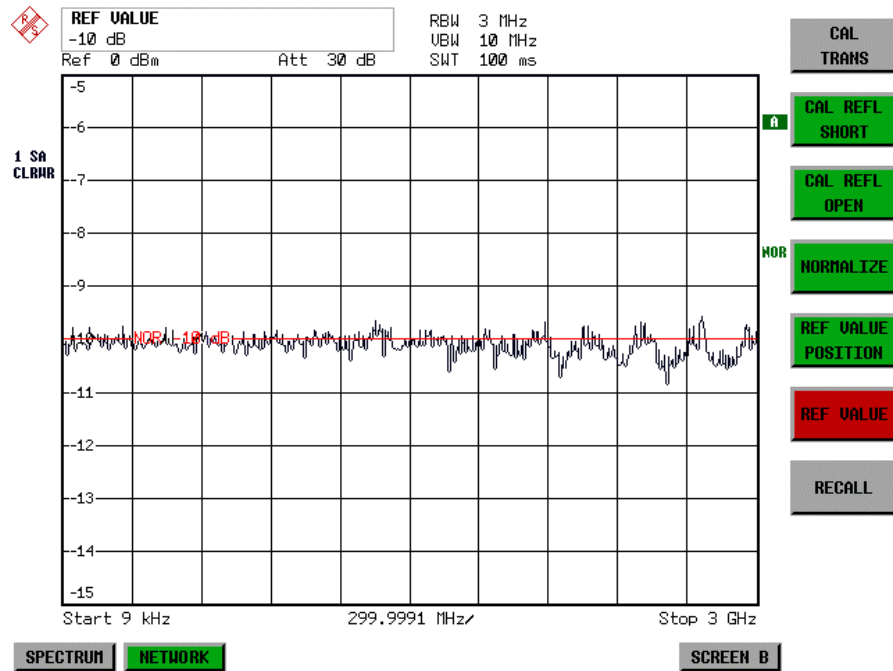
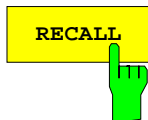

Fig. 4.21-6 Measurement of a 10dB attenuator pad with 1dB/DIV

IEC/IEEE-bus command: `DISP:WIND:TRAC:Y:RVAL -10dB`



The *RECALL* softkey restores the FSP settings that were used during source calibration.

This can be useful if device settings were changed after calibration (eg center frequency, frequency deviation, reference level, etc).

The softkey is only available if:

- the NETWORK mode has been selected
- the memory contains a calibration dataset.

IEC/IEEE-bus command: `CORR:REC`

Reflection Measurement

Scalar reflection measurements can be carried out by means of a reflection-coefficient measurement bridge.

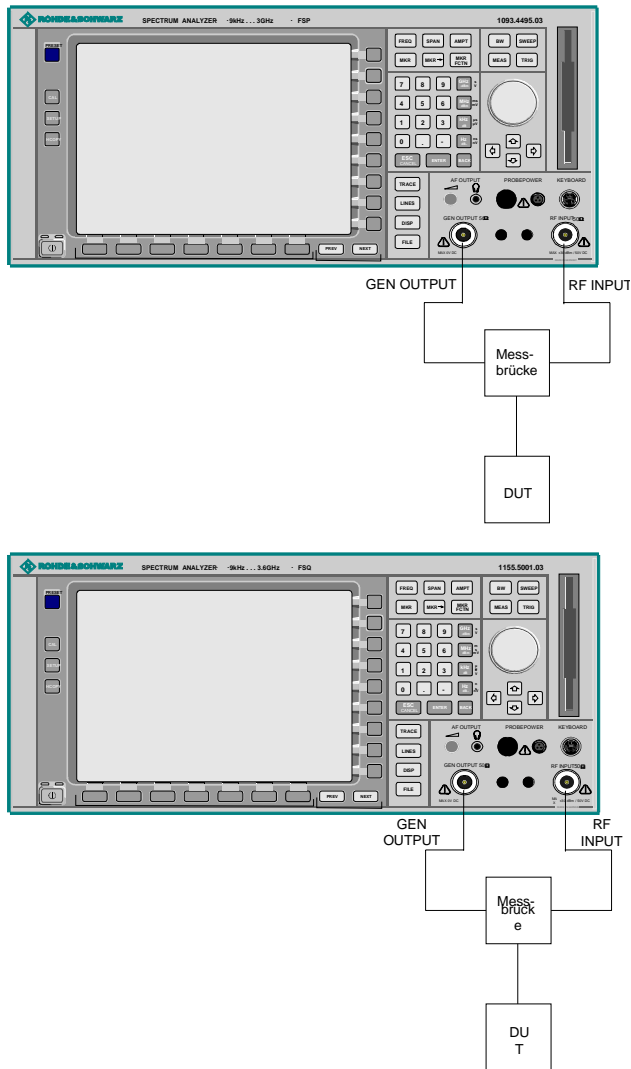
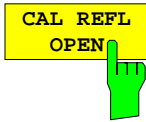

Fig. 4.21-7 Test Setup for Reflection Measurement

Calibration of Reflection Measurement

The calibration mechanism for reflection measurement is basically the same as the one used for transmission measurement.

NETWORK-SOURCE CAL submenu



The *CAL REFL OPEN* softkey starts the open-circuit calibration. During calibration the following message is displayed:



IEC/IEEE-bus command: CORR:METH REFL
CORR:COLL OPEN



The *CAL REFL SHORT* softkey starts the short-circuit calibration.

If both calibrations (open circuit, short circuit) are carried out, the calibration curve is calculated by averaging the two measurements and stored in the memory. The order of the two calibration measurements is free.

After the calibration the following message is displayed:

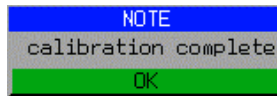

The message is cleared after approx. 3 seconds.

IEC/IEEE-bus command: CORR:METH REFL

Calibration mechanism

Calibration means a calculation of the difference between the currently measured power and a reference curve, independent of the selected type of measurement (transmission/reflection). The hardware settings used for measuring the reference curve are included in the reference dataset.

Even with normalization switched on, the device settings can be changed in a wide area without stopping the normalization. This reduces the necessity to carry out a new normalization to a minimum.

For this purpose the reference dataset (trace with 501 measured values) is stored internally as a table of 501 points (frequency/level).

Differences in level settings between the reference curve and the current device settings are taken into account automatically. If the span is reduced, a linear interpolation of the intermediate values is applied. If the span increases, the values at the left or right border of the reference dataset are extrapolated to the current start or stop frequency, ie the reference dataset is extended by constant values.

An enhancement label is used to mark the different levels of measurement accuracy. This enhancement label is displayed at the right diagram border when normalization is switched on and a deviation from the reference setting occurs. Three accuracy levels are defined:

Table 4.21-1 Measurement accuracy levels

Accuracy	Enhancement label	Reason/Limitation
High	NOR	No difference between reference setting and measurement
Medium	APX (approximation)	Change of the following settings: <ul style="list-style-type: none"> • coupling (RBW, VBW, SWT) • reference level, RF attenuation • start or stop frequency • output level of tracking generator • frequency offset of tracking generator • detector (max. peak, min. peak, sample, etc.) Change of frequency: <ul style="list-style-type: none"> • max. 501 points within the set sweep limits (corresponds to a doubling of the span)
-	Aborted normalization	<ul style="list-style-type: none"> • more than 500 extrapolated points within the current sweep limits (in case of span doubling)

Note: At a reference level (REF LEVEL) of -10 dBm and at a tracking generator output level of the same value the FSP operates without overrange reserve, ie the FSP is in danger of being overloaded if a signal is applied whose amplitude is higher than the reference line. In this case, either the message "OVLD" for overload is displayed in the status line or the display range is exceeded (clipping of the trace at the upper diagram border = Overrange).

Overloading can be avoided as follows:

- Reducing the output level of the tracking generator (SOURCE POWER, NETWORK menu)
- Increasing the reference level (REF LEVEL, AMPT menu)

Frequency-Converting Measurements

For frequency-converting measurements (eg on converter units) the tracking generator is able to set a constant frequency offset between the output frequency of the tracking generator and the receive frequency of the FSP.

Up to an output frequency of 150 MHz the measurement can be carried out in both inverted and normal positions.

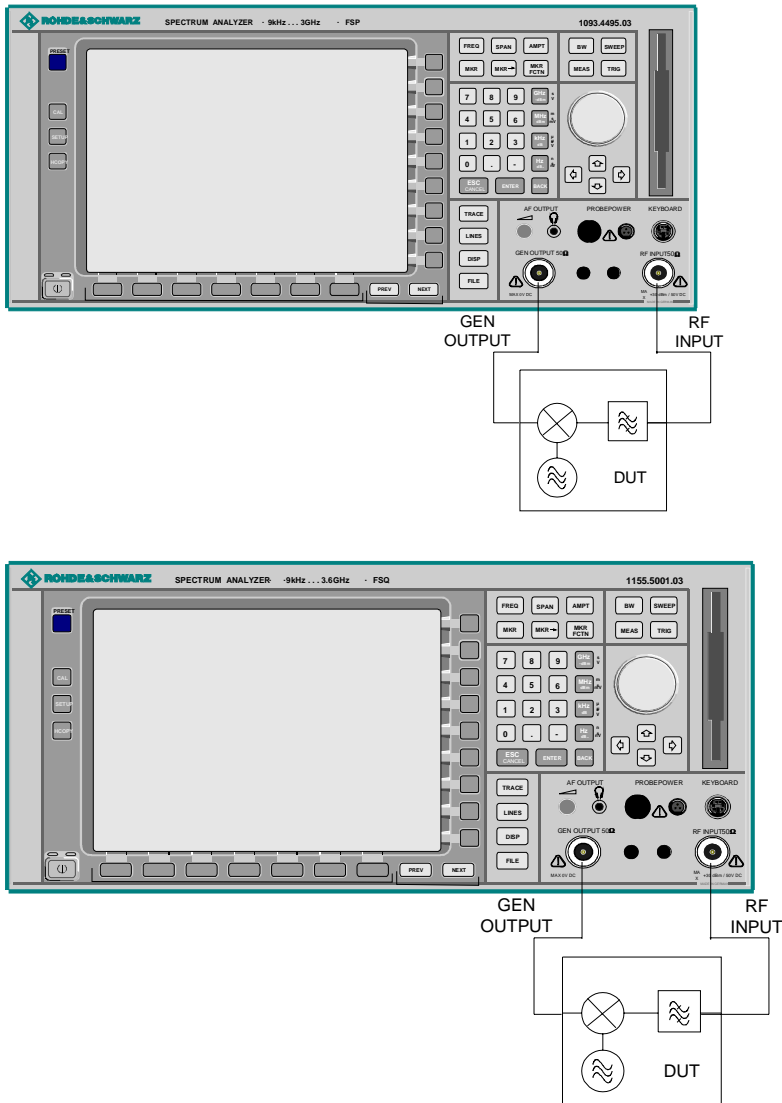
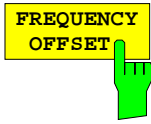

Fig. 4.21-8 Test setup for frequency converting measurements

NETWORK menu



The *FREQUENCY OFFSET* softkey activates the input of the frequency offset between the output signal of the tracking generator and the input frequency of the FSP. Possible offsets are in a range of ± 150 MHz in 0.1 Hz steps.

The default setting is 0 Hz. Offsets $\neq 0$ Hz are marked with the enhancement label **FRQ**.

If a positive frequency offset is entered, the tracking generator generates an output signal above the receive frequency of the FSP. In case of a negative frequency offset it generates a signal below the receive frequency of the FSP. The output frequency of the tracking generator is calculated as follows:

Tracking generator frequency = receive frequency + frequency offset.

IEC/IEEE-bus command: `SOUR:FREQ:OFFS 50MHz`

External Modulation of the Tracking Generator

NETWORK menu:

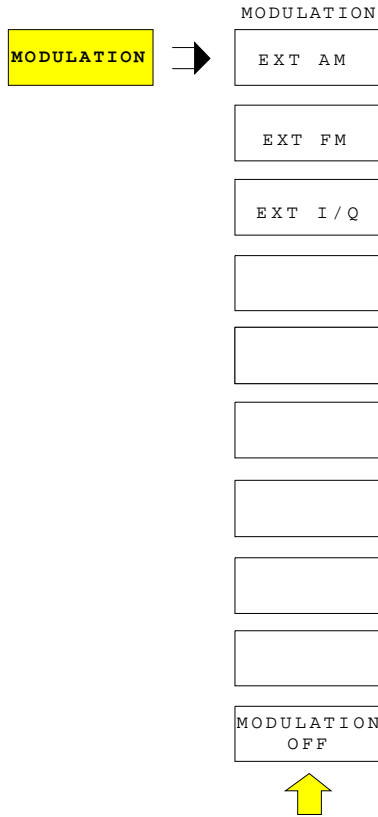

The *MODULATION* softkey opens a submenu for selecting different modulation modes.

The time characteristics of the tracking generator output signal can be influenced by means of external signals (input voltage range -1 V to +1 V).

Two BNC connectors at the rear panel are available as signal inputs. Their function changes depending on the selected modulation:

TG IN I / AM and
TG IN Q / FM

The modulation modes can be combined with each other and with the frequency offset function up to a certain degree. The following table shows which modulation modes are possible at the same time and which ones can be combined with the frequency offset function.

Table 4.21-2 Simultaneous modes of modulation (tracking generator)

Modulation	Frequency offset	EXT AM	EXT FM	EXT I/Q
Frequency offset		•	•	•
EXT AM	•		•	
EXT FM	•	•		
EXT I/Q	•			

• = can be combined

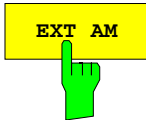

The *EXT AM* softkey activates an AM modulation of the tracking generator output signal.

The modulation signal is applied to the *TG IN I / AM* connector. An input voltage of 1 V corresponds to 100% amplitude modulation.

Switching on an external AM disables the following function:

- active I/Q modulation.

IEC/IEEE-bus command: `SOUR:AM:STAT ON`

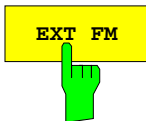

The *EXT FM* softkey activates the FM modulation of the tracking generator output signal.

The modulation frequency range is 1 kHz to 100 kHz, the deviation can be set in 1-decade steps in the range of 100 Hz to 10 MHz at an input voltage of 1 V. The phase deviation η should not exceed the value 100.

$$\text{Phase deviation } \eta = \text{deviation} / \text{modulation frequency}$$

The modulation signal is applied to the *TG IN Q / FM* connector.

Switching on an external FM disables the following function:

- active I/Q modulation.

IEC/IEEE-bus command: `SOUR:FM:STAT ON`
`SOUR:FM:DEV 10MHz`

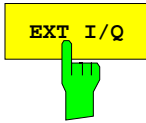

The *EXT I/Q* softkey activates the external I/Q modulation of the tracking generator.

The signals for modulation are applied to the two input connectors *TG IN I* and *TG IN Q* at the rear panel of the unit. The input voltage range is ± 1 V into 50 Ω .

Switching on an external I/Q modulation disables the following functions:

- active external AM
- active external FM

Functional description of the quadrature modulator:

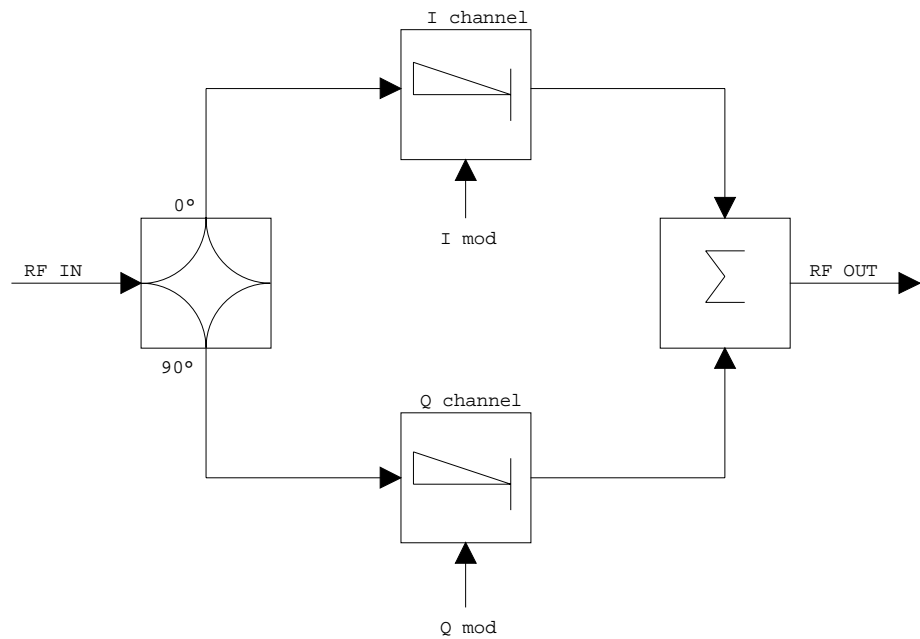
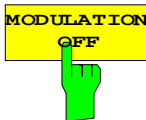

Fig. 4.21-9 I/Q modulation

I/Q modulation is performed by means of the built-in quadrature modulator. The RF signal is divided into two orthogonal I and Q components (inphase and quadrature phase). Amplitude and phase are controlled in each path by the I and Q modulation signal. By adding the two components an RF output signal is generated that can be controlled in amplitude and phase.

IEC/IEEE-bus command: `SOUR:DM:STAT ON`



The *MODULATION OFF* softkey switches off the modulation of the tracking generator.

IEC/IEEE-bus command: `SOUR:AM:STAT OFF`
`SOUR:FM:STAT OFF`
`SOUR:DM:STAT OFF`

Option External Generator Control - FSP-B10

The external generator control option permits to operate a number of commercially available generators as tracking generator on the FSQ. Thus, scalar network analysis with the FSQ is also possible outside the frequency range of the internal tracking generator when the appropriate generators are used.

The FSQ also permits to set a frequency offset for frequency-converting measurements when external generators are used. For harmonics measurements or frequency-converting measurements, it is also possible to enter a factor, by which the generator frequency is increased or reduced compared with the receive frequency of the FSQ. Only make sure that the resulting generator frequencies do not exceed the allowed setting range of the generator.

The settable level range also depends on the generator used.

The generator is controlled via the – optional – second IECBUS interface of the FSQ (= IEC2, supplied with the option) and, with some Rohde & Schwarz generators, additionally via the TTL synchronization interface included in the AUX interface of the FSQ.

Note: *The use of the TTL interface enables considerably higher measurement rates as pure IECBUS control, because the frequency stepping of the FSQ is directly coupled with the frequency stepping of the generator.*

Therefore, the frequency sweep differs according to the capabilities of the generator used:

- In the case of generators without TTL interface, the generator frequency is first set for each frequency point via IECBUS, then the setting procedure has to be completed before recording of measured values is possible.
- In the case of generators with TTL interface, a list of the frequencies to be set is entered into the generator before the beginning of the first sweep. Then the sweep is started and the next frequency point selected by means of the TTL handshake line TRIGGER. The recording of measured values is only enabled when the generator signals the end of the setting procedure via the BLANK signal. This method is considerably faster than pure IECBUS control.

With the "SELECT GENERATOR" softkey, a list of the supported generators with the frequency and level range as well as the capabilities used is included.

The external generator can be used in all operating modes. Recording of test setup calibration values (*SOURCE CAL*) and normalization with the correction values (*NORMALIZE*) are only possible in the *NETWORK* mode.

Note: *In order to enhance measurement accuracy a common reference frequency should be used for both the FSQ and the generator. If no independent 10 MHz reference frequency is available, it is recommended to connect the reference output of the generator with the reference input of the FSQ and to enable usage of the external Reference on the FSQ via SETUP – REFERENCE EXT.*

Like the internal tracking generator, the external generator is activated by means of the *NETWORK* hotkey in the hotkey bar at the screen bottom:

The image shows a portion of a device's hotkey bar. It contains two buttons: 'SPECTRUM' and 'NETWORK'. The 'NETWORK' button is highlighted with a green background, indicating it is the active or selected mode.The image shows a portion of a device's hotkey bar. It contains one button: 'SCREEN B'. The button has a grey background.

External Generator Settings

The *NETWORK* hotkey opens the menu for setting the functions of the external generator.

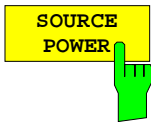
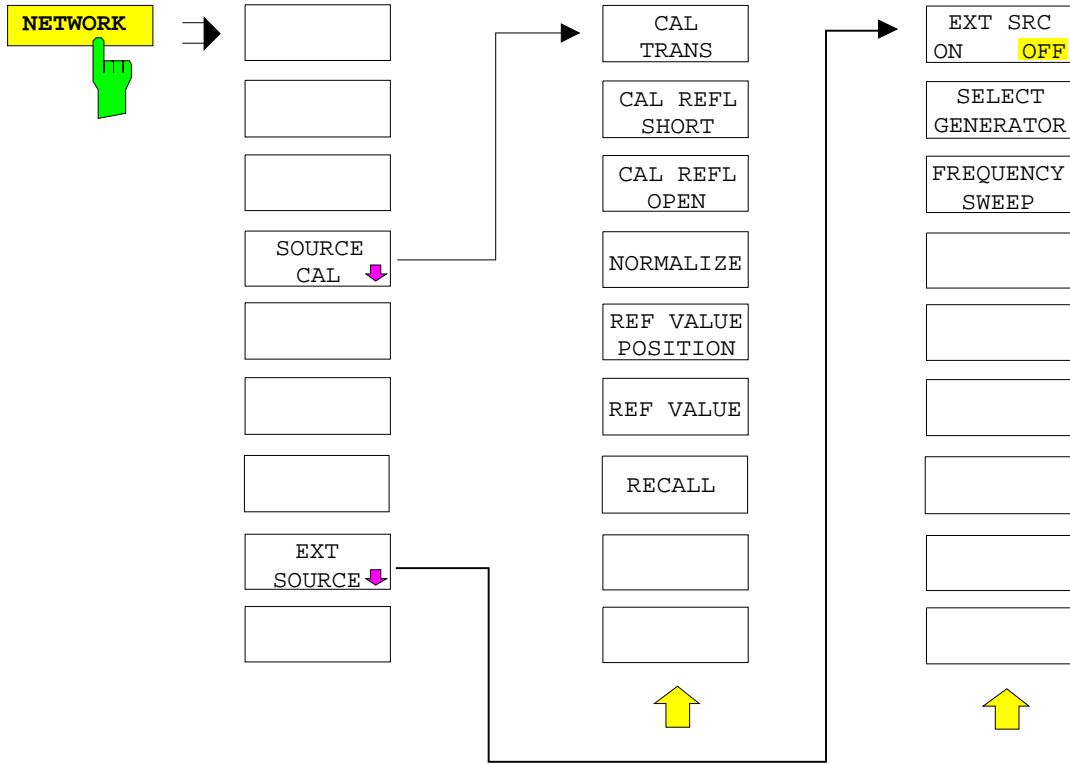

The *SOURCE POWER* softkey activates the input of the generator output level. The value range depends on the selected generator (See table of chapter "Configuration of the External Generator").

IEC/IEEE-bus command: `SOUR:EXT:POW -20dBm`

Transmission Measurement

The transmission characteristic of a two-port network is measured. The external generator serves as a signal source. It is connected to the input connector of the DUT. The input of the analyser is fed from the output of the DUT.

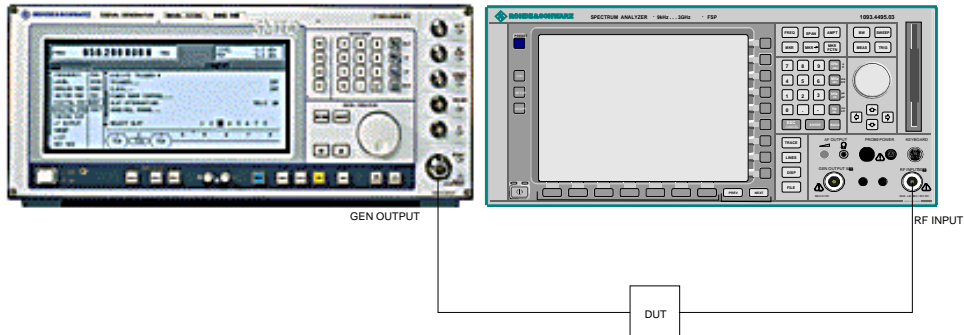
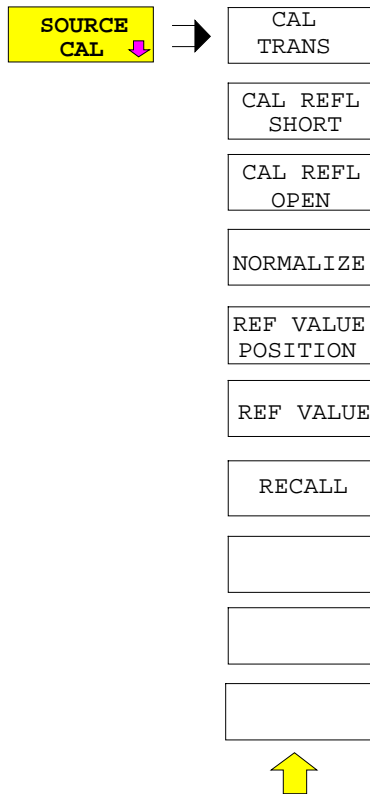

Fig. Fehler! Kein Text mit angegebener Formatvorlage im Dokument.-27 Test setup for transmission measurement

A calibration can be carried out to compensate for the effects of the test setup (eg frequency response of connecting cables).

Calibration of Transmission Measurement

NETWORK menu:



The *SOURCE CAL* softkey opens a submenu comprising the calibration functions for the transmission and reflection measurement.

The calibration of the reflection measurement (*CAL REFL...*) and its functioning are described in separate sections.

To carry out a calibration for transmission measurements the whole test setup is through-connected (THRU).

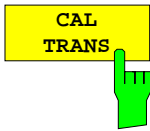

The *CAL TRANS* softkey triggers the calibration of the transmission measurement.

It starts a sweep that records a reference trace. This trace is then used to obtain the differences to the normalized values.

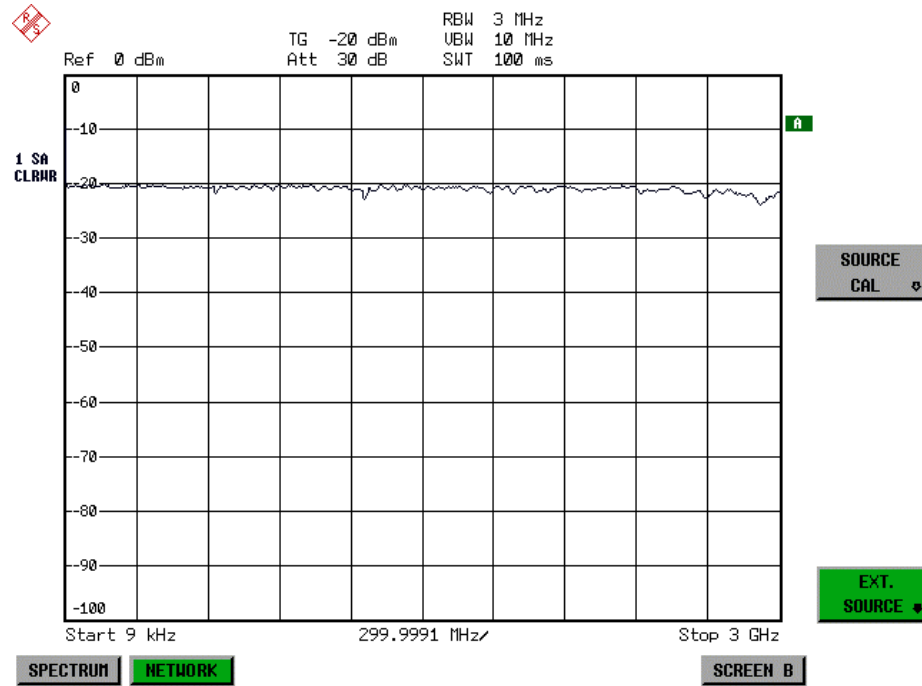
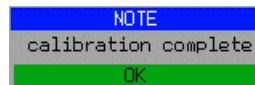

Fig. Fehler! Kein Text mit angegebener Formatvorlage im Dokument.-28
 Calibration curve for transmission measurement

During the calibration the following message is displayed:



After the calibration sweep the following message is displayed:



This message is cleared after approx. 3 seconds.

IEC-bus command CORR:METH TRAN

Normalization:

NETWORK -SOURCE CAL menu:

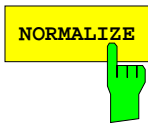

The *NORMALIZE* softkey switches normalization on or off. The softkey is only available if the memory contains a correction trace.

It is possible to shift the relative reference point within the grid using the *REF VALUE POSITION* softkey. Thus, the trace can be shifted from the top grid margin to the middle of the grid:

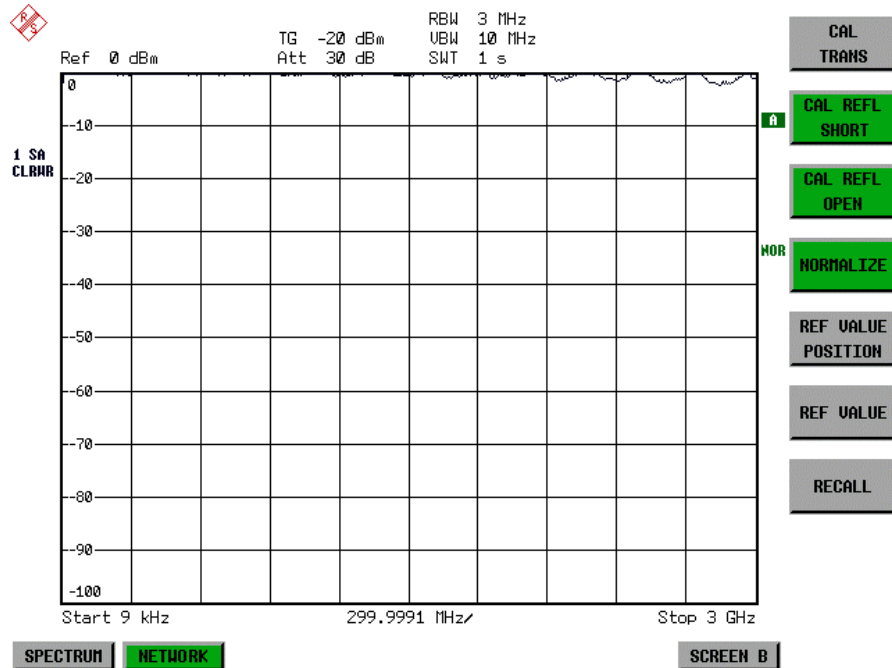
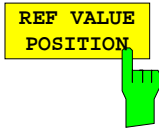

Fig. Fehler! Kein Text mit angegebener Formatvorlage im Dokument.-29 Normalized display

In the *SPLIT SCREEN* setting, the normalization is switched on in the current window. Different normalizations can be active in the two windows.

Normalization is aborted when the *NETWORK* mode is quit.

IEC/IEEE-bus command: CORR ON



The *REF VALUE POSITION* softkey (reference position) marks a reference position in the active window on which the normalization (difference formation with a reference curve) is performed.

When pressed for the first time, the softkey switches on the reference line and activates the input of its position. The line can be shifted within the grid limits.

The reference line is switched off by pressing the softkey again.

The function of the reference line is explained in the section "Functioning of Calibration".

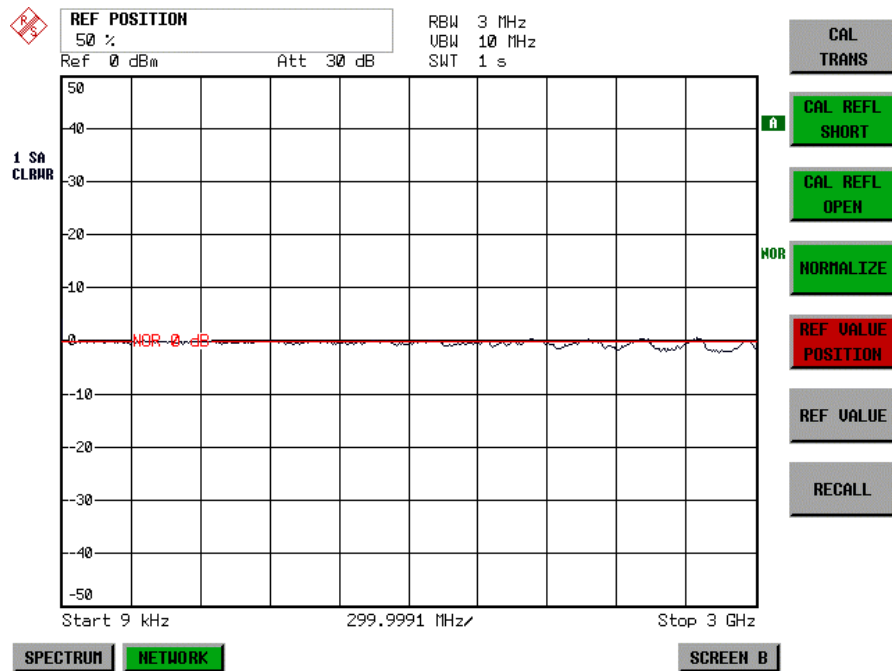
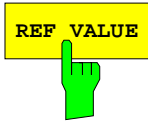

Fig. Fehler! Kein Text mit angegebener Formatvorlage im Dokument.-30 Normalized measurement, shifted with *REF VALUE POSITION* 50 %

IEC-bus command DISP:WIND:TRAC:Y:RPOS 10PCT



The *REF VALUE* softkey activates the input of a level difference which is assigned to the reference line.

In the default setting, the reference line corresponds to a level difference of 0 dB. If e.g. a 10-dB attenuator pad is inserted between DUT and analyzer input between recording of the calibration data and normalization, the trace will be shifted down by 10 dB. By entering a *REF VALUE* of -10 dB the reference line for difference formation can also be shifted down by 10 dB so that it will again coincide with the trace (see Fig. Fehler! Kein Text mit angegebener Formatvorlage im Dokument.-31).

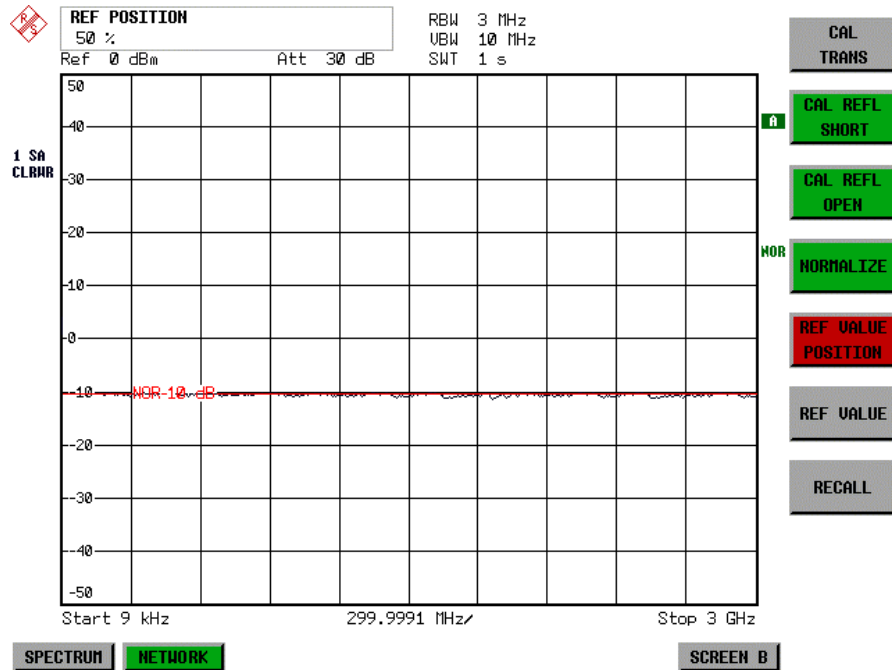

Fig. Fehler! Kein Text mit angegebener Formatvorlage im Dokument.-31 Measurement with REF VALUE -10dB and REF VALUE POSITION 50%

After the reference line has been shifted by entering *REF VALUE* -10 dB, departures from the nominal value can be displayed with high resolution (e.g. 1 dB / Div.). The absolute measured values are still displayed, in the above example, 1 dB below nominal value (reference line) = 11 dB attenuation.

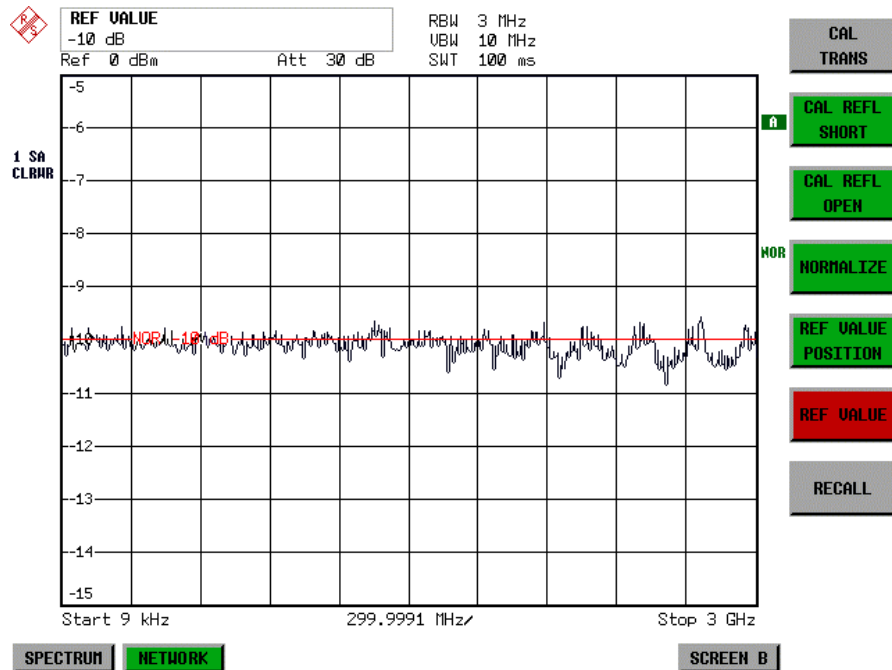
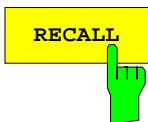

Fig. Fehler! Kein Text mit angegebener Formatvorlage im Dokument.-32 Measurement of a 10-dB attenuator pad with 1dB/DIV

IEC-bus command DISP:WIND:TRAC:Y:RVAL -10dB



The *RECALL* softkey restores the instrument setting with which the calibration was carried out. This can be useful if the device setting was changed after calibration (eg center frequency setting, frequency deviation, reference level, etc).

The softkey is only available if:

- the *NETWORK* mode has been selected
- the memory contains a calibration data set.

IEC/IEEE-bus command CORR:REC

Reflection Measurement

Scalar reflection measurements can be carried out by means of a reflection-coefficient bridge.

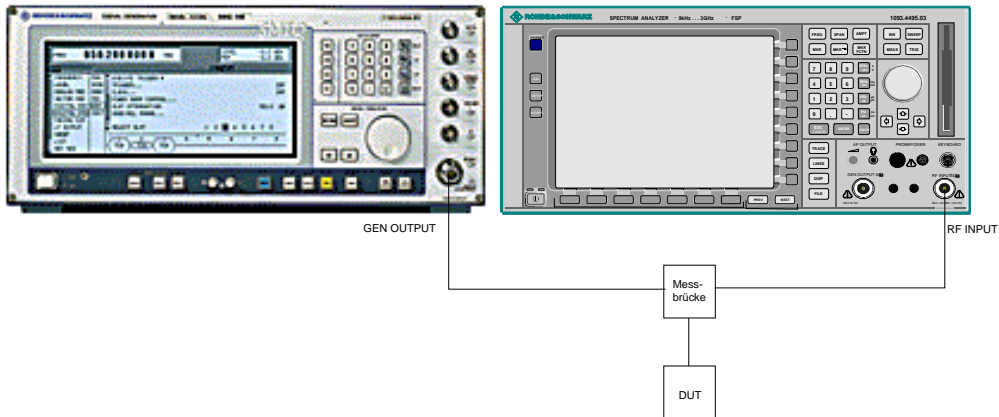

Fig. Fehler! Kein Text mit angegebener Formatvorlage im Dokument.-33 Test setup for reflection measurement

Calibration of Reflection Measurement

The calibration mechanism essentially corresponds to that of the transmission measurement.

NETWORK-SOURCE CAL submenu



The *CAL REFL OPEN* softkey starts the open-circuit calibration. During calibration the following message is displayed:



IEC-bus command CORR:METH REFL
 CORR:COLL OPEN



The *CAL REFL SHORT* softkey starts the short-circuit calibration.

If both calibrations (open circuit, short circuit) are carried out, the calibration curve is formed by averaging the two measurements and stored in the memory. The order of measurements is optional.

After the calibration the following message is displayed:

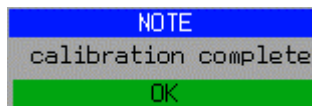

The display is cleared after approx. 3 seconds.

IEC-bus command CORR:METH REFL
 CORR:COLL THR

Calibration mechanism

Calibration means a calculation of the difference between the currently measured power and a reference curve, independent of the selected type of measurement (transmission/reflection). The hardware settings used for measuring the reference curve are included in the reference dataset.

Even with normalization switched on, the device settings can be changed in a wide area without stopping the normalization. This reduces the necessity to carry out a new normalization to a minimum.

For this purpose the reference dataset (trace with 501 measured values) is stored internally as a table of 501 points (frequency/level).

Differences in level settings between the reference curve and the current device settings are taken into account automatically. If the span is reduced, a linear interpolation of the intermediate values is applied. If the span increases, the values at the left or right border of the reference dataset are extrapolated to the current start or stop frequency, ie the reference dataset is extended by constant values.

An enhancement label is used to mark the different levels of measurement accuracy. This enhancement label is displayed at the right diagram border when normalization is switched on and a deviation from the reference setting occurs. Three accuracy levels are defined:

Table Fehler! Kein Text mit angegebener Formatvorlage im Dokument.-5 Measurement accuracy levels

Accuracy	Enhancement label	Reason/Limitation
High	NOR	No difference between reference setting and measurement
Medium	APX (approximation)	Change of the following settings: <ul style="list-style-type: none"> • coupling (RBW, VBW, SWT) • reference level, RF attenuation • start or stop frequency • output level of tracking generator • frequency offset of tracking generator • detector (max. peak, min. peak, sample, etc.) Change of frequency: <ul style="list-style-type: none"> • max. 501 points within the set sweep limits (corresponds to a doubling of the span)
-	Aborted normalization	<ul style="list-style-type: none"> • more than 500 extrapolated points within the current sweep limits (in case of span doubling)

Note: At a reference level (REF LEVEL) of -10 dBm and at a tracking generator output level of the same value the analyzer operates without overrange reserve, ie the analyzer is in danger of being overloaded if a signal is applied whose amplitude is higher than the reference line. In this case, either the message "OVLD" for overload is displayed in the status line or the display range is exceeded (clipping of the trace at the upper diagram border = Overage).

Overloading can be avoided as follows:

- Reducing the output level of the tracking generator (SOURCE POWER, NETWORK menu)
- Increasing the reference level (REF LEVEL, AMPT menu)

Frequency-converting Measurements

For frequency-converting measurements (e.g. on converters) the external generator is able to set a constant frequency offset between the output frequency of the generator and the receive frequency of the analyzer and, in addition, the generator frequency as a multiple of the analyzer.

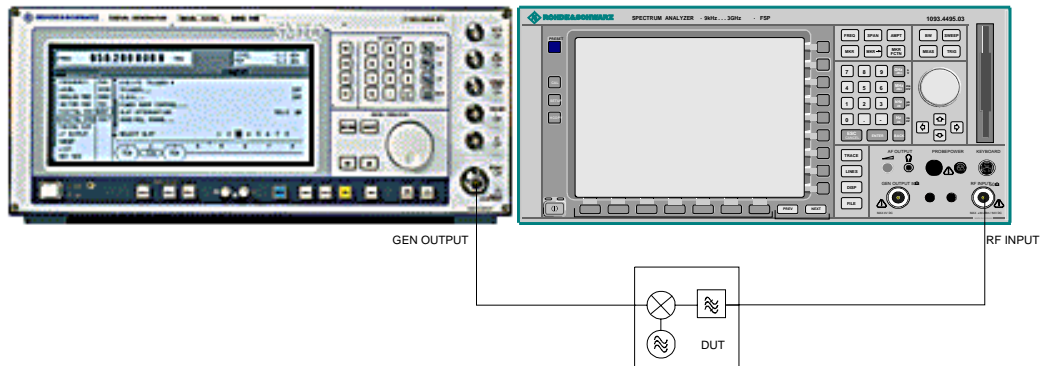
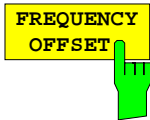

Fig. Fehler! Kein Text mit angegebener Formatvorlage im Dokument.-34 Test setup for frequency-converting measurements

NETWORK Menü



The *FREQUENCY OFFSET* softkey activates the input of the frequency offset between the output signal of the generator and the input frequency of the analyzer. The value range depends on the selected generator. The default setting is 0 Hz. Offsets $<> 0$ Hz are marked with the enhancement label **FRQ**.

If a positive frequency offset is entered, the tracking generator generates an output signal above the receive frequency of the analyzer. In case of a negative frequency offset it generates a signal below the receive frequency of the analyzer. The output frequency of the generator is calculated as follows:

$$\text{Generator frequency} = \text{receive frequency} + \text{frequency offset}$$

IEC/IEEE-bus command: `SOUR:EXT:FREQ:OFFS 1GHZ`

Configuration of an External Generator

NETWORK menu:

SELECT GENERATOR								
SRC	TYPE	IFC	GPIB ADDR	MODE	F MIN	F MAX	P MIN	P MAX
1	SME03	TTL	28	REMOTE	5kHz	3GHz	-144dBm	16dBm
2	SMIQ03	GPIB	28	LOCAL	300kHz	3.3GHz	-140dBm	13dBm

FREQUENCY SWEEP						
SRC	STATE	POWER[dBm]	NUM	DEN	OFFSET	RESULT
1	✓	-30dBm	1	1	0Hz	0Hz..3GHz *
2		-30dBm	1	1	0Hz	0Hz..3.2GHz



The **EXT SOURCE** softkey opens a submenu for configuration of the external generator. The FSQ is able to manage two generators, one of which can be active at the time.

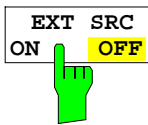

The **EXT SRC ON / OFF** softkey switches the external generator on or off. It can only be switched on successfully if the generator has been selected by means of **SELECT GENERATOR** and configured correctly by means of **FREQUENCY SWEEP**. If one of these conditions is not fulfilled, an error message will be output.

Notes:

When switching on the external generator, the FSQ switches off the internal tracking generator and starts programming the generator settings via the IECBUS.

At the same time, the maximum stop frequency is limited to the maximum generator frequency. This upper limit is automatically reduced by the set frequency offset of the generator and a set multiplication factor.

With the external generator switched on, the FFT filters (**FILTER TYPE FFT** in the menu **BW**) are not available.

If there is an error on the IECBUS during programming of the external generator, the generator is automatically switched off and the following error message output:



IEC-bus command SOUR:EXT ON

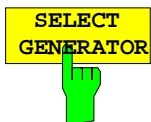

The **SELECT GENERATOR** softkey opens a table for selection of the generator and definition of IECBUS address and control interface. The table permits configuration of two generators so that switching between two different configurations is easily possible.

SELECT GENERATOR								
SRC	TYPE	IFC	GPIB ADDR	MODE	F MIN	F MAX	P MIN	P MAX
1	SME03	TTL	28	REMOTE	5kHz	3GHz	-144dBm	16dBm
2	SMIQ03	GPIB	28	LOCAL	300kHz	3.3GHz	-140dBm	13dBm

The individual fields contain the following settings:

- SRC Index of generator selected
- TYPE The field opens the list with the available generators:

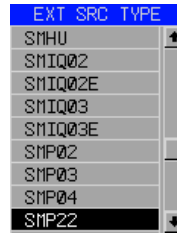

After completion of the selection, the remaining fields of the table are filled with the generator characteristics.

A list of generator types supported by the FSQ is to be found at the end of section "Softkey *SELECT GENERATOR*".

- IFC This field selects the interface type of external generator 1or 2. The following types are available:

GPIB IECBUS only, suitable for all generators of other manufacturers and some Rohde & Schwarz instruments
or

TTL IECBUS and TTL interface for synchronization, for most of the Rohde & Schwarz generators, see table above.

The two operating modes differ in the speed of the control: Whereas, with pure IECBUS operation, each frequency to be set must be individually transferred to the generator, additional use of the TTL interface permits to program a total frequency list at once and subsequently perform the frequency stepping via TTL handshake, which is a big advantage in terms of speed.

Note:

Generators equipped with the TTL interface can also be operated with IECBUS (= GPIB) only.

Only one of the two generators can be operated with TTL interface at a time. The other generator must be configured for IECBUS (GPIB).

- GPIB ADDR IECBUS address of the respective generator. Addresses from 0 to 30 are possible.

- MODE Operating mode of generator. The generator activated using the FREQUENCY SWEEP softkey is automatically set to remote mode (REMOTE), the other to manual mode (LOCAL).

- F MIN Frequency range of generator. Select the start and stop frequency of the FSQ in a way that the specified range is not exceeded.

If the start frequency lies below F MIN, the generator is only switched on when F MIN is reached.

If the stop frequency lies above F MAX, it is limited to F MAX when the generator is switched on using the EXT SRC ON/OFF softkey.

- P MIN Level range of generator. This field defines the allowed input range for the POWER column in the FREQUENCY SWEEP table.

- IEC-bus commands SYST:COMM:RDEV:GEN2:TYPE 'SME02'
SYST:COMM:RDEV:GEN:LINK TTL
SYST:COMM:GPIB:RDEV:GEN1:ADDR 28

List of Generator Types Supported by the FSQ

Generator	Interface Type	Generator Min Freq	Generator Max Freq	Generator Min Power dBm	Generator Max Power dBm
SME02	TTL	5 kHz	1.5 GHz	-144	+16
SME03	TTL	5 kHz	3.0 GHz	-144	+16
SME06	TTL	5 kHz	6.0 GHz	-144	+16
SMG	GPIB	100 kHz	1.0 GHz	-137	+13
SMGL	GPIB	9 kHz	1.0 GHz	-118	+30
SMGU	GPIB	100 kHz	2.16 GHz	-140	+13
SMH	GPIB	100 kHz	2.0 GHz	-140	+13
SMHU	GPIB	100 kHz	4.32 GHz	-140	+13
SMIQ02B	TTL	300 kHz	2.2 GHz	-144	+13
SMIQ02E	GPIB	300 kHz	2.2 GHz	-144	+13
SMIQ03B	TTL	300 kHz	3.3 GHz	-144	+13
SMIQ03E	GPIB	300 kHz	3.3 GHz	-144	+13
SMIQ04B	TTL	300 kHz	4.4 GHz	-144	+10
SMIQ06B	TTL	300 kHz	6.4 GHz	-144	+10
SML01	GPIB	9 kHz	1.1 GHz	-140	+13
SML02	GPIB	9 kHz	2.2 GHz	-140	+13
SML03	GPIB	9 kHz	3.3 GHz	-140	+13
SMR20	TTL	1 GHz	20 GHz	-130 ²⁾	+11 ²⁾
SMR20B11 ¹⁾	TTL	10 MHz	20 GHz	-130 ²⁾	+13 ²⁾
SMR27	TTL	1 GHz	27 GHz	-130 ²⁾	+11 ²⁾
SMR27B11 ¹⁾	TTL	10 MHz	27 GHz	-130 ²⁾	+12 ²⁾
SMR30	TTL	1 GHz	30 GHz	-130 ²⁾	+11 ²⁾
SMR30B11 ¹⁾	TTL	10 MHz	30 GHz	-130 ²⁾	+12 ²⁾
SMR40	TTL	1 GHz	40 GHz	-130 ²⁾	+9 ²⁾
SMR40B11 ¹⁾	TTL	10 MHz	40 GHz	-130 ²⁾	+12 ²⁾
SMR60	TTL	1 GHz	60 GHz	-130 ²⁾	+9 ²⁾
SMR60B11 ¹⁾	TTL	10 MHz	60 GHz	-130 ²⁾	+12 ²⁾
SMP02	TTL	10 MHz	20 GHz	-130 ³⁾	+17 ³⁾
SMP03	TTL	10 MHz	27 GHz	-130 ³⁾	+13 ³⁾
SMP04	TTL	10 MHz	40 GHz	-130 ³⁾	+12 ³⁾
SMP22	TTL	10 MHz	20 GHz	-130 ³⁾	+20 ³⁾
SMT02	GPIB	5.0 kHz	1.5 GHz	-144	+13
SMT03	GPIB	5.0 kHz	3.0 GHz	-144	+13
SMT06	GPIB	5.0 kHz	6.0 GHz	-144	+13
SMV03	GPIB	9 kHz	3.3 GHz	-140	+13
SMX	GPIB	100 kHz	1.0 GHz	-137	+13
SMY01	GPIB	9 kHz	1.04 GHz	-140	+13
SMY02	GPIB	9 kHz	2.08 GHz	-140	+13
HP8340A	GPIB	10 MHz	26.5 GHz	-110	10
HP ESG-A Series 1000A, 2000A, 3000A, 4000A	GPIB	250 kHz	4 GHz	-136	20
HP ESG-D SERIES E4432B	GPIB	250 kHz	3 GHz	-136	+10

1) Requires the option SMR-B11 to be fitted.

2) Maximum/minimum power depends on presence of Option SMR-B15/-B17 and set frequency range. For more details see SMR data sheet.

3) Maximum/minimum power depends on presence of Option SMP-B15/-B17 and set frequency range. For more details see SMP data sheet.



The *FREQUENCY SWEEP* softkey opens a table for setting the generator level as well as the multiplier and the offset used to derive the generator frequency from the analyzer frequency.

This table also permits configuration of two generators so that switching between two different configurations is easily possible.

FREQUENCY SWEEP						
SOURCE FREQ = REC FREQ * NUM/DEN + OFFSET						
SRC	STATE	POWER[dBm]	NUM	DEN	OFFSET	RESULT
1	✓	-30dBm	1	1	0Hz	0Hz..3GHz *
2		-30dBm	1	1	0Hz	0Hz..3.2GHz

- SRC Index of selected generator
- STATE Selects the active generator. Only one generator can be active at a time. The operating mode of the active generator is set to remote control in the *SELECT GENERATOR* table.
- POWER Permits to enter the generator level within the limits P MIN to P MAX of the *SELECT GENERATOR* table.
- NUM Numerator,
- DEN Denominator,
- OFFSET Offset, used to derive the generator frequency from the current frequency of the FSQ according to the following formula:

$$F_{Generator} = F_{Analyzer} * \frac{Numerator}{Denominator} + F_{Offset}$$

Note that the frequencies resulting from start and stop frequency of the FSQ do not exceed the allowed generator range:

- If the start frequency lies below F MIN, the generator is only switched on when F MIN is reached.
- If the stop frequency lies above F MAX, the generator is switched off. When the generator is subsequently switched on using the *EXT SRC ON/OFF* softkey, the stop frequency is limited to F MAX.
- If the stop frequency lies below F MIN, the generator is switched off and the following error message output:

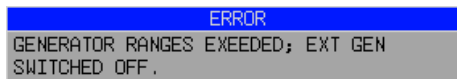

- In the time domain (Span = 0 Hz) the generator frequency is derived from the set receive frequency of the FSQ using the calculation formula.

For the sake of clarity, the formula is also displayed in the table.

RESULT The frequency range of the generator resulting from the calculation formula. An asterisk (*) after the upper limit indicates that the stop frequency of the FSQ must be adapted when the generator is switched on in order not to exceed its maximum frequency. In the following illustration, this is true for the upper generator at a stop frequency of 3.2 GHz of the FSQ, whereas the lower generator does not yet require an adaptation:

SOURCE FREQ = REC FREQ * NUM/DEN + OFFSET				
	NUM	DEN	OFFSET	RESULT
	1	1	0Hz	0Hz..3GHz *
	1	1	0Hz	0Hz..3.2GHz

IEC-bus commands SOUR:EXT:POW -30dBm
 SOUR:EXT:FREQ:NUM 4
 SOUR:EXT:FREQ:DEN 3
 SOUR:EXT:FREQ:OFFS 100MHZ

OPTION LAN Interface

Using the option FSP-B16, LAN Interface, the instrument can be connected to an Ethernet LAN (Local Area Network). Thus it is possible to transfer data via the network and use network printers. In addition, the instrument can be remote-controlled via network. The network card allows both for a 10 MHz Ethernet IEEE 802.3 and a 100 MHz Ethernet IEEE 802.3u.

Connecting the Instrument to the Network



Caution:

Before connecting the instrument to the network it is recommended to contact the network administrator, in particular larger LAN installations are affected. Faults in the connection may have a negative effect on the entire network.

The instrument is connected to a network hub of the desired LAN segment via a commercially-available RJ45 cable (not supplied with the instrument) at the instrument rear panel. Since RJ45 provides no bus but a star network topology, no other precautions need to be taken for the connection.

The connection procedure does not produce any disturbances in the network traffic. Disconnection from the network is easily possible provided that there is no more data traffic from and to the instrument.

Installing the Software

The data transfer in the network takes place in data blocks, called packets. In addition to the useful data, further information on the operation, i.e. protocol data (transmitter, receiver, type of data, sequence), is transferred in the packets. For processing the protocol information, suitable drivers must be installed. For the network services (file transfer, directory services, printing in the network) a network operating system needs to be installed.

- Notes:
- The WINDOWS files required for the installation of network drivers, protocols or services are included in the directory "D:\V386".
 - A PC keyboard with trackball (or an additional mouse instead) is required for the installation.

Installation of Drivers for the Network Card

If the option R&S FSP-B16 has already been factory-installed, the network-card drivers do not have to be installed under Windows XP. It is sufficient to connect the network cable to the "LAN-Interface" connector at the rear of the unit. Windows XP will automatically recognize the network link and will activate the required drivers.

Note:

If the original factory setting is required at a later time, i.e. when the unit is to be operated with a different network configuration at a different site, this base configuration can be restored as described below:

- Switch the unit off and on again.
- In the Boot menu, select the entry "Analyzer Firmware Backup" with the cursor keys and confirm with *ENTER*. The device is started from the backup partition and opens a selection window with available device configurations:

```

* * * * *
* INSTRUMENT RESTORE PROCEDURE V 1.4      (c) RSD 2002
*
* Note:
* The presence of the LAN-interface requires
* a restore process different from the standard firmware
* restore (due to the necessary network drivers).
*
* The following 3 selections will NOT destroy user defined
* limit lines and transducer data
*
* Press 1   to perform standard system RESTORE
* press 2   to perform system RESTORE with LAN interface
* press 3   to ABORT system RESTORE
*
* The following selection will DESTROY user defined
* limit lines and transducer data
*
* Press 4   to perform standard system RESTORE
*           (destroys user limit lines and transducers !!!)
* press 5   to perform system RESTORE with LAN interface,
*           (destroys user limit lines and transducers !!!)
*
* * * * *

```

- Press 2. Windows XP is newly installed on the analyzer partition of the hard disk with LAN support and device firmware. The device may boot several times. At the end of the installation procedure, the device firmware will be restarted.

The unit is again ready for operation. The configuration of the network protocols then has to be performed according to the following sections.

Configuration of Available Network Protocols (TCP/IP Protocol)

When the unit is delivered, the TCP/IP network protocol is factory-set with the IP address 10.0.0.10 and the subnet mask 255.255.255.0. The steps required to change this configuration and to install further network protocols are described in this and the following sections.

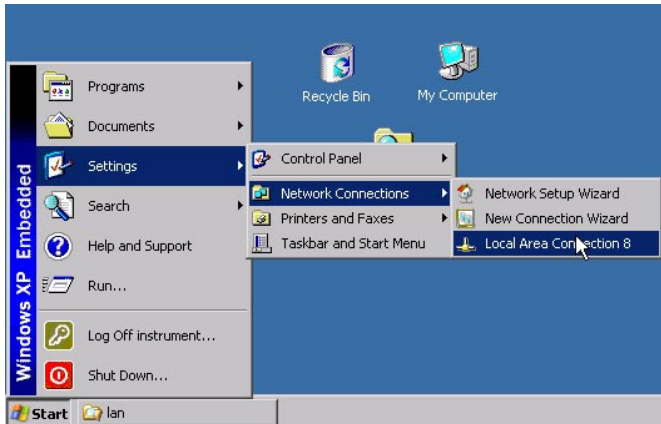

- Open the Windows XP start menu with the Windows key or *CTRL-ESC*.
- Click *Settings - Network Connections - Local Area Connection*.

The *Local Area Connection Status* dialog will be opened.

Note:

Windows XP appends numbers to the name *Local Area Connection Status* (e.g. *Local Area Connection Status 8*) if the configuration is created with the *New Connection Wizard*. These numbers are irrelevant for the following configurations and are therefore not mentioned in the text.

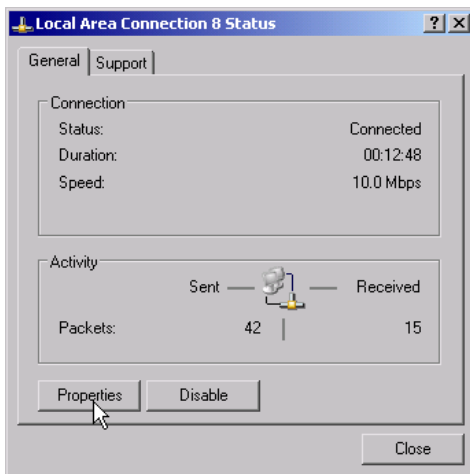

- Click the *Properties* button.
The window with the available network protocols will be opened.

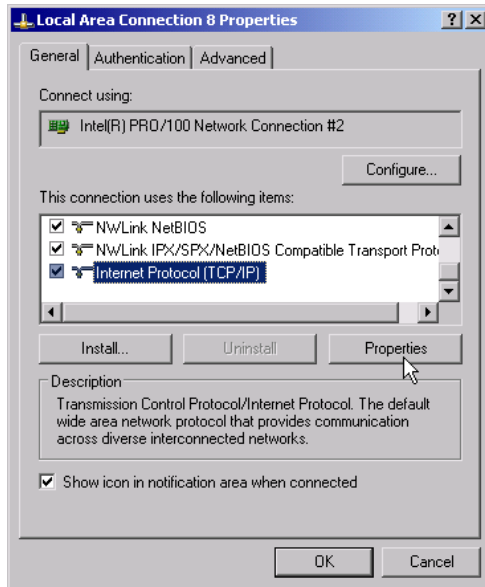

- Click the desired network protocol (in the example: TCP/IP).
- Click the *Properties* button.

The dialog with the settings of the selected network protocol will be opened.

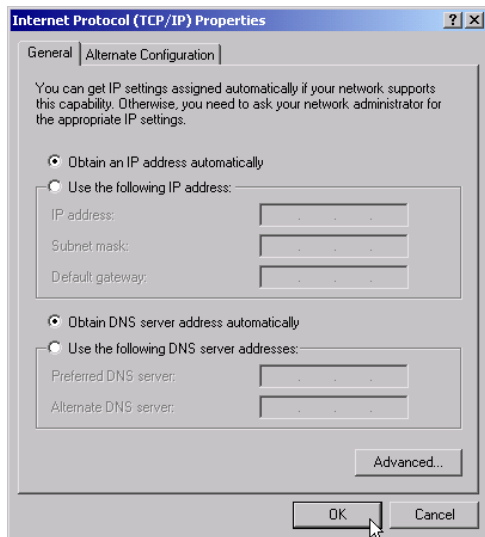

- If the IP address is to be automatically requested by a DHCP server, click the entry *Obtain an IP address automatically*.

Note:

Your network administrator knows whether your network has a DHCP server.

- Click the OK button. Windows will store the configuration.

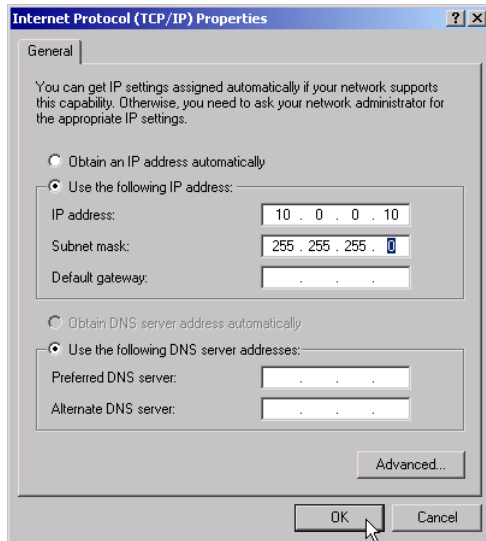

- If a predefined IP address is to be set (since no DHCP server is available in the network), click the entry *Use the following IP address*.
- Click the entry *IP address* and enter the IP address.
- Then click the entry *Subnet mask* and enter the required mask.

Note:

Your network administrator knows which IP addresses and subnet masks are suitable for your network.

- Click the OK button. Windows checks whether the entered settings are correct and stores the configuration.

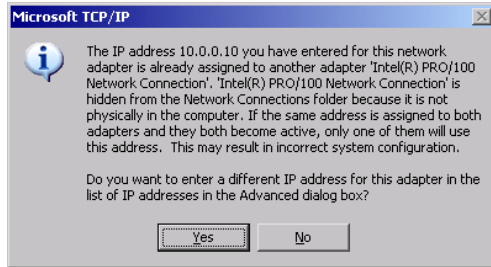

If an invalid IP address or subnet mask was entered, a corresponding error message will be displayed together with a question as whether a different address or mask is to be entered.

- Click the Yes button.
The dialog for entering the TCP/IP parameters will again be opened.

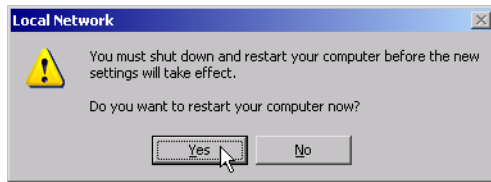

If all settings are correct, the request to start the unit again will be displayed depending on the changed settings.

- Click the Yes button.
Windows will restart the system.

Installation of Further Network Protocols and Services (e.g. Novell Netware Support)

Note: The network administrator knows the protocols to be used. The TCP/IP protocol has to be installed for the RSIB protocol and the VX11 support. The support for the Novell netware is additionally installed in the following example.

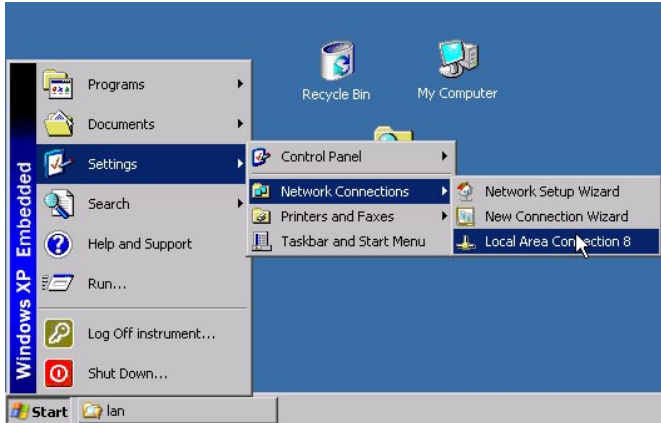

- Open the Windows XP start menu using the Windows key or *CTRL-ESC*.
- Click *Settings - Network Connections - Local Area Connection*.

The *Local Area Connection Status* dialog will be opened.

Note: Windows XP appends numbers to the name *Local Area Connection Status* (e.g. *Local Area Connection Status 8*) if the configuration is created with the *New Connection Wizard*. These numbers are irrelevant for the following configurations and are therefore not mentioned in the text.

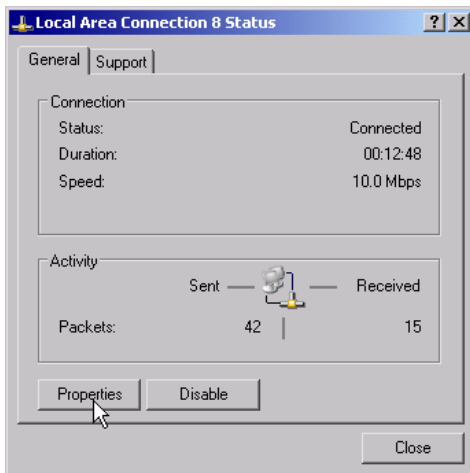

- Press the *Properties* button. The window with the available network protocols will be opened.

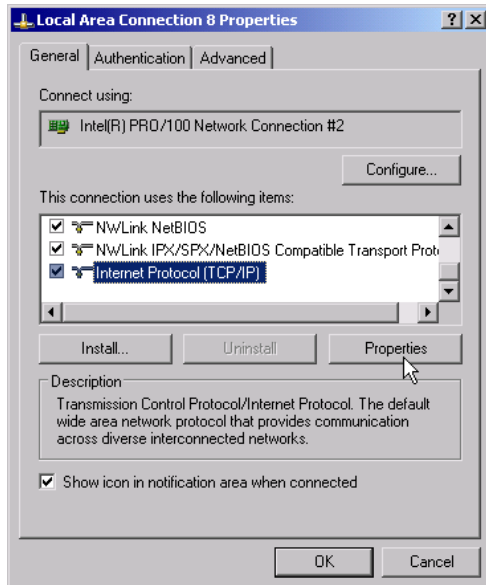

- Click the *Install* button.

The list of installable network components will be opened.

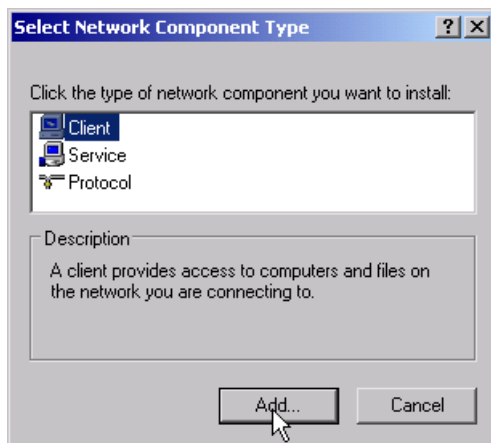

- Select *Client*.
- Click the *Add...* button.

The list of available network protocols will be opened.

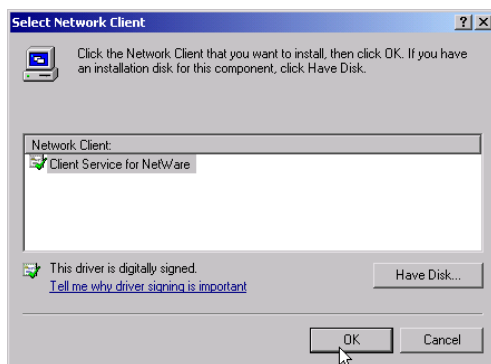

- Select *Client Service for NetWare*.
- Click the *OK* button.

The network driver for Novell Netware is installed.

Note:

- Your network administrator knows which clients, services and protocols have to be installed for your network.
- If network components not contained in D:\1386 are to be installed, a corresponding disk including the drivers has to be prepared (or a CD that can be read via a USB CD-ROM drive).

In this case, click the *Have Disk...* button and indicate the path with the corresponding drivers.

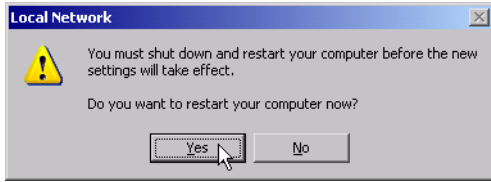

After completion of the installation, the user is requested to restart the unit.
 ➤ Click the Yes button.
 Windows will restart the system.

Examples of Configurations

Network	Protocols	Services	Notes
NOVELL Netware	NWLink IPX/SPX Compatible Transport	Client Service for NetWare	In folder "Protocols - Properties", the frame type used in the network is to be set.
IP Networks (FTP, TELNET, WWW, GOPHER, etc)	TCP/IP Protocol	Simple TCP/IP Services	In folder "Protocols - Properties", an IP address that is unique in the network is to be set.
MICROSOFT Network	NetBEUI Protocol or TCP/IP Protocol	Workstation Server	In folder "Identification - Computer Name", a name that is unique in the network is to be entered.

Subsequent Changing of the Network Configuration (Computer Name, Domain, Workgroup, etc)

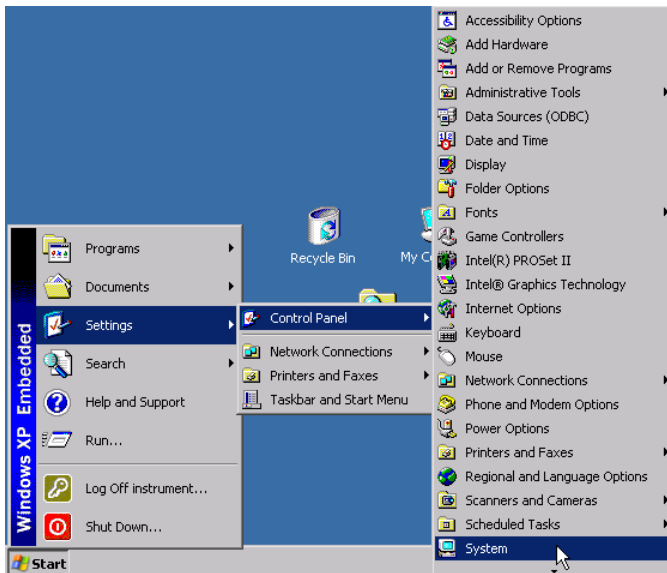

After completion of the installation, the computer name can be adapted as follows:

- Press the Windows key or <CTRL><ESC>.
- The Windows Start menu will be opened.
- Select Settings - Control Panel - System.

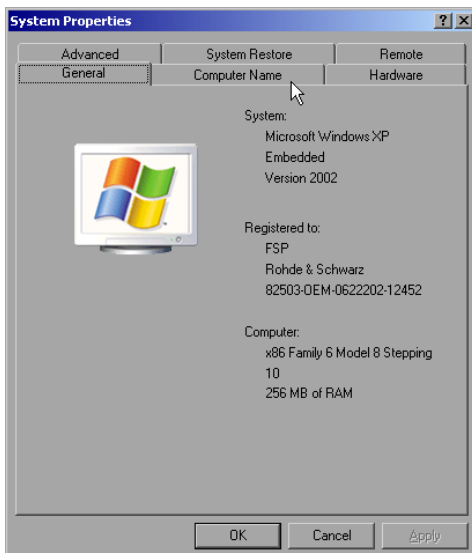

- Select the "Computer Name" tab.

Note:

The other settings can be changed after selection of the other tabs. It is strongly recommended to consult the network administrator beforehand.

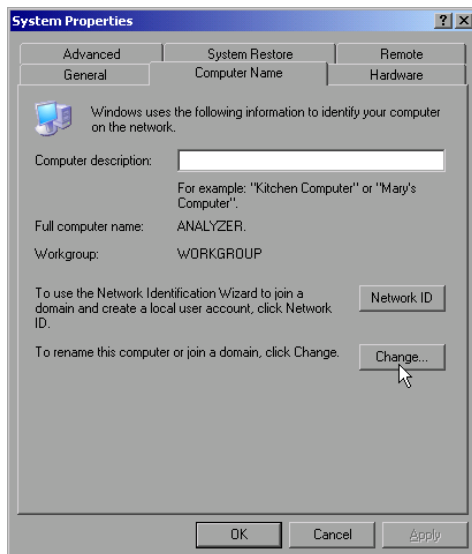

- Click the *Change* button.

The dialog to change the computer name, the domain and workgroup will be opened.

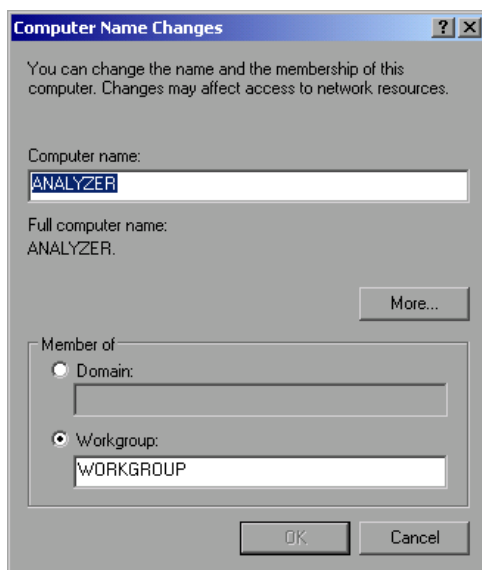

- Enter a new computer name.
- If required, enter the desired domain or workgroup.
- Confirm the changes with *OK*.

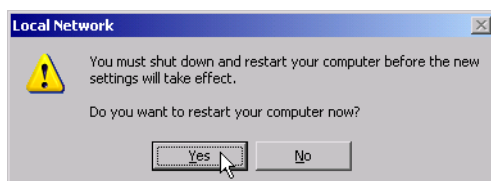

If the request to restart the unit is displayed:

- Click the *Yes* button.
Windows will restart the system.

Operating the Instrument without a Network

If the instrument is to be operated without any network connection for a limited or unlimited period of time, or permanently, no special precautions have to be taken in contrast to Windows NT. Windows XP automatically recognizes the interruption of the network connection and will not carry out any setup when the instrument is switched on.

If the user name and the password are not to be queried, proceed as described in section "Reenabling the Autologin Mechanism".

Operating the Instrument on the Network

After the network support has been installed, it is possible to exchange data between the instrument and other computers and to use printers in the network.

A prerequisite to network operation is having the appropriate access rights for the required network resources. Resources may be file directories of other computers or also central printers.

Access rights can be obtained from the network or server administrator. In that respect it is necessary to obtain the network name of the resource as well as the corresponding access rights.

To prevent misuse, the resources are protected by passwords. Normally, every entitled user of the resources is assigned a user name that is also protected by a password. Resources can then be assigned to this user. It is possible to determine the type of data access, i.e. whether data can only be read or also written, as well as shared data access. Depending on the network operating system, different types of usage are possible.

NOVELL Networks

The operating system NETWARE from NOVELL is a server-based system. Data cannot be exchanged between individual workstations; data transfer takes place between the PC and a server. This server provides memory space and the connection to network printers. On a server, data is organized in directories as under DOS and mapped to the workstation as virtual drives. A virtual drive behaves like an additional hard disk on the workstation, and the data can be edited accordingly. Network printers can also be addressed like normal printers.

There are two versions of the NOVELL network operating system: bindary-based (NETWARE 3) and NDS-based (more recent versions of NETWARE). With the older version (NETWARE 3), each server manages its resources on its own and is independent. A user must be managed on each server separately. In the case of NDS-based versions, all resources in the network are managed together in the NDS (NOVELL DIRECTORY SERVICE). The user must log into the network only once and is given access to the resources according to his/her access rights. The individual resources and users are managed as objects in a hierarchical tree (NDS TREE). The position of the object in the tree is referred to as "CONTEXT" with NETWARE and must be known for access to the resources.

MICROSOFT Network

In case of a MICROSOFT network, data can be exchanged both between workstations (peer to peer) and between workstations and servers. The latter can supply access to files and connection to the printers. On a server, data is organized in directories as under DOS and mapped to the workstation as virtual drives. A virtual drive behaves like an additional hard disk on the workstation, and the data can be edited accordingly. Network printers can also be addressed like normal printers. A connection is possible to DOS, WINDOWS FOR WORKGROUPS, WINDOWS95/98/ME, WINDOWS NT/XP.

Defining Users

After the network driver software has been installed, the instrument will output an error message on the next power-on, as there is no user called "Instrument" (= user name for XP autologin) in the network. It is therefore necessary to define a common user for Windows XP, to adapt the password to the network password and the network and to disable the autologin mechanism subsequently.

The definition of new users in the network is done by the network administrator. For definition of a new user on the instrument, the User Account Assistant is required:

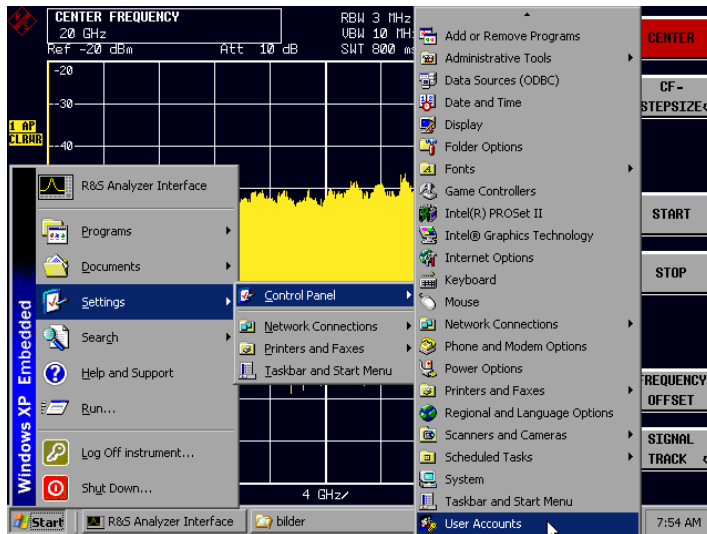

- Call up the Windows XP start menu using the Windows key or the key combination <CTRL> <ESC>.
- Then click "Settings", "Control Panel" and "User Accounts" one after the other.

The User Accounts wizard with the *Pick a task...* dialog will be opened.

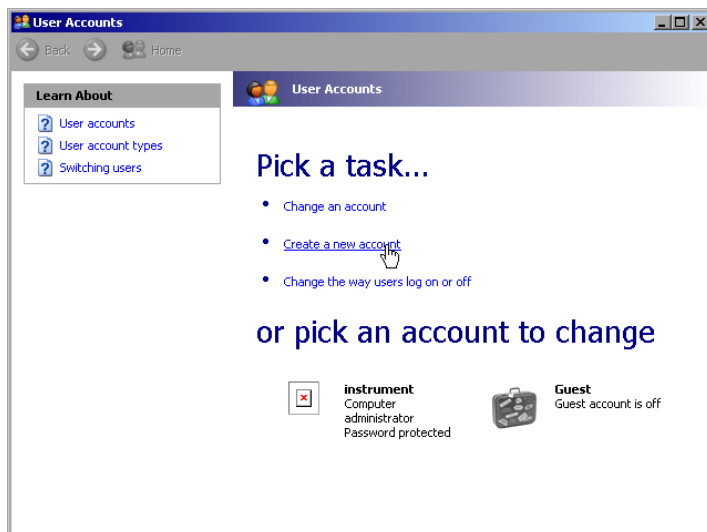

- Select "Create a new account" .

The dialog to enter a new user name will be opened.

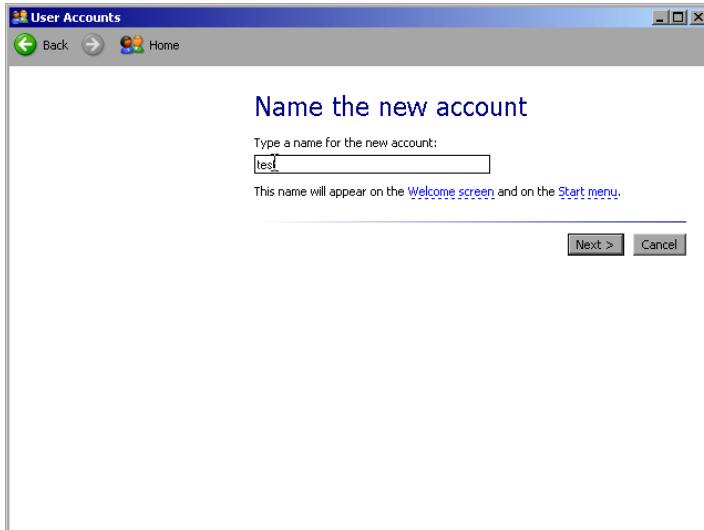

- Enter the name of the new user into the text field and terminate the entry with "Next ->".

The *Pick an account type* dialog to select the user rights will be opened.

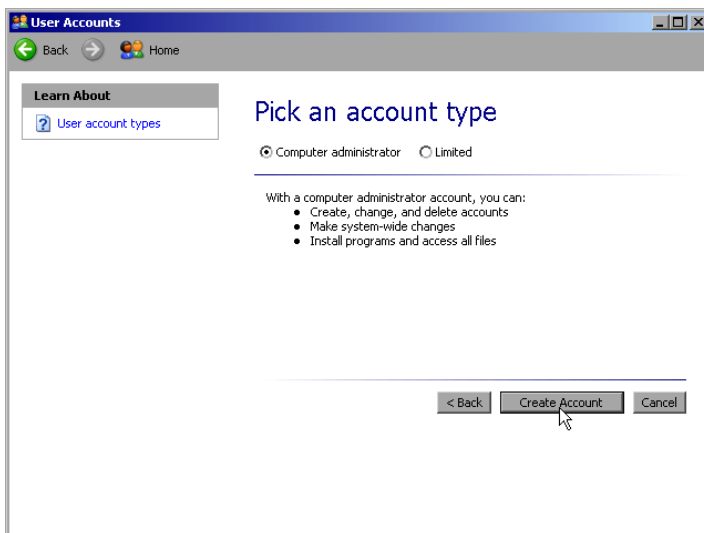

- Select *Computer administrator*.

Note:

Administrator rights are required to ensure trouble-free operation of the firmware.

- Confirm the newly created user with the *Create Account* button.

The new user is created.

Changing the User Password

After the new user has been created, the password has to be adapted to the network password. This is also done via the User Accounts wizard:

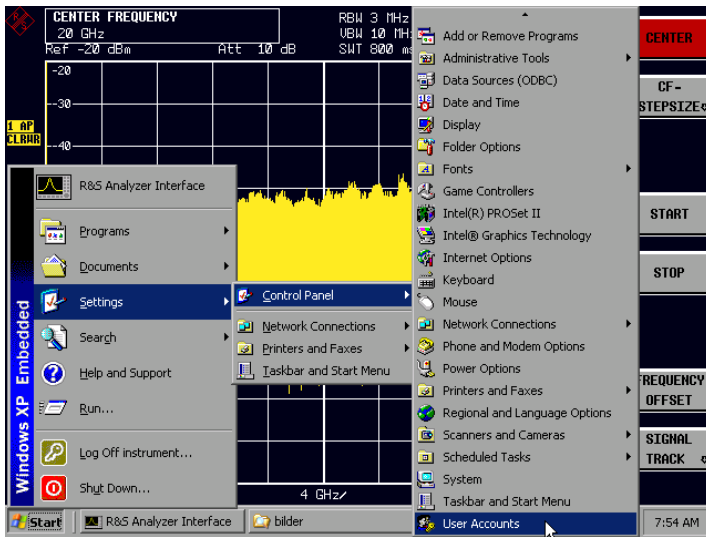

- Call up the Windows XP start menu using the Windows key or the key combination <CTRL> <ESC>.
- Then click "Settings", "Control Panel" and "User Accounts" one after the other.

The User Accounts wizard with the *Pick a task...* dialog will be opened.

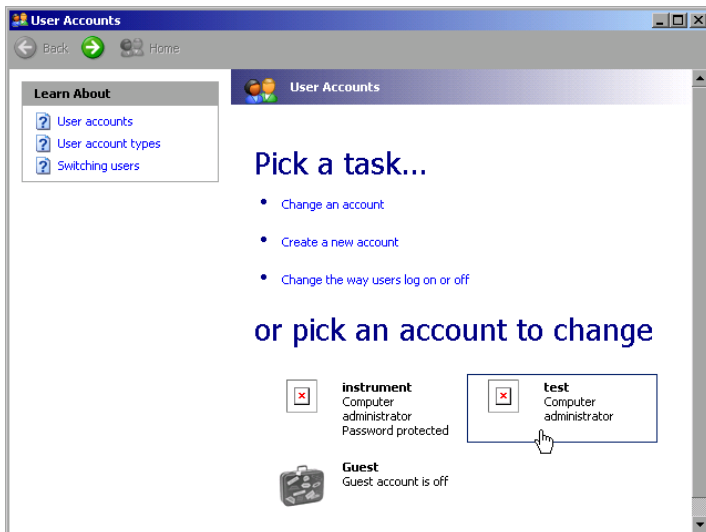

- Click the required user account (in the example: "test"). The dialog to select the desired action will be opened.

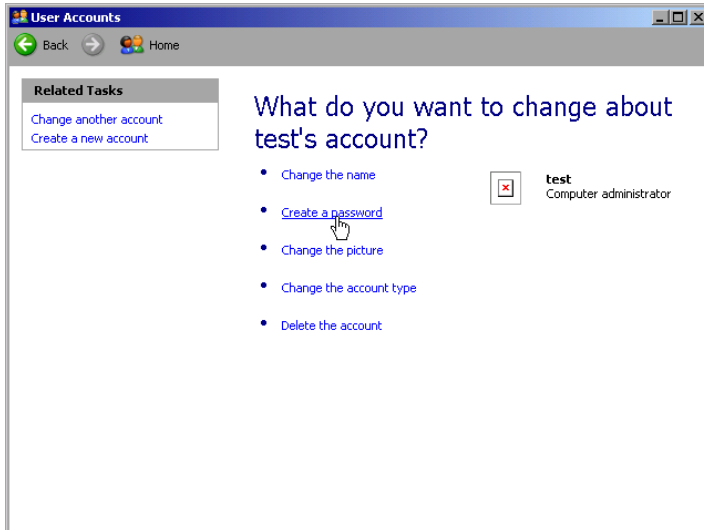

➤ Click *Create a password*.

The dialog to enter a new password will be opened.

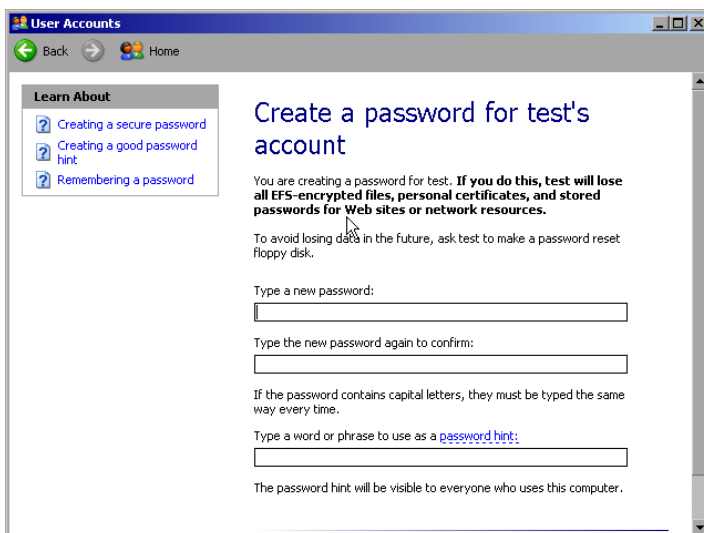

➤ Enter the new password in the upper text line and repeat the entry in the line below.

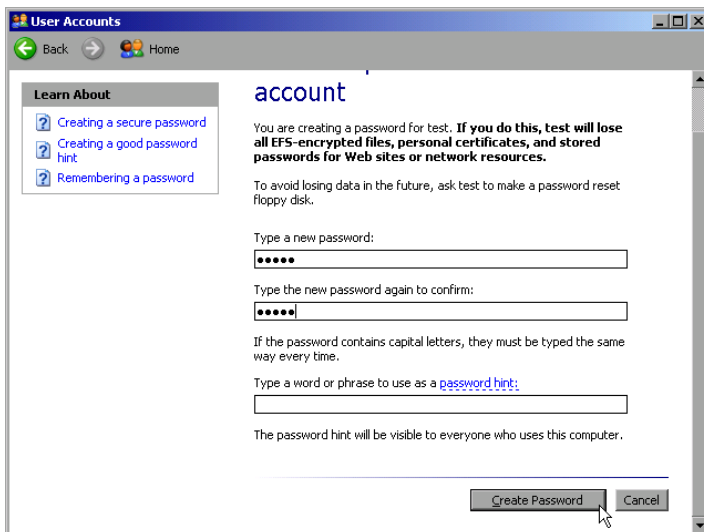

➤ Scroll the picture contents downwards and terminate the entry with the *Create Password* button.

The new password is activated.

NOVELL network only: Configure NOVELL client

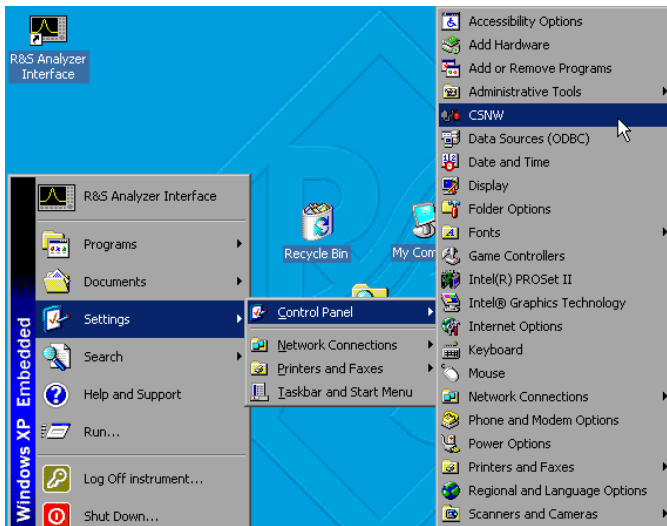

- Call up the Windows XP start menu using the Windows key or the key combination <CTRL> <ESC>.
- Then click "Settings", "Control Panel" and "CSNW" one after the other.

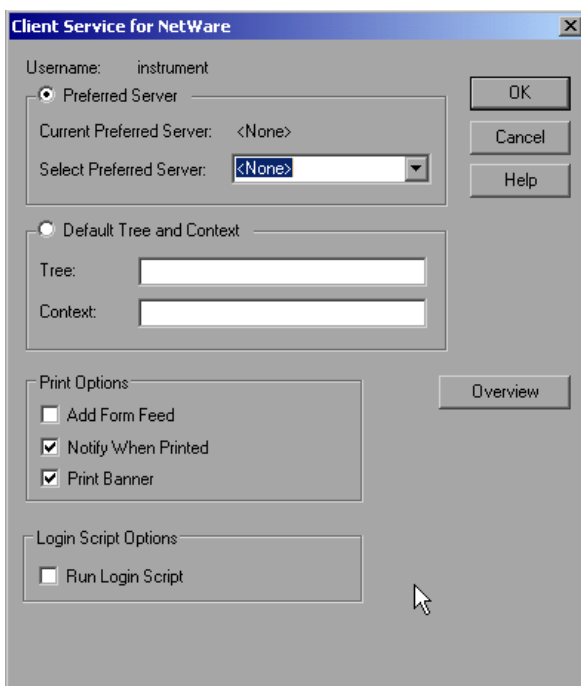

Bindary login (NOVELL 3.x)

- Click "Preferred Server".
- Select the NOVELL server where the user is configured using "Select Preferred Server".

NDS login (more recent NOVELL versions)

- Click "Default Tree and Context".
- Enter the NDS Tree under "Tree" and the hierarchical path where the user is defined under "Context".
- If required, click the "Run Login Script" entry.

Note: *This data can be obtained from the network administrator.*

- Terminate the Login configuration with "OK".

Login in the Network

The user automatically logs into the network with the registration in the operating system. As a prerequisite, the user name and the password must be identical under Windows XP and on the network.

Disabling the Autologin Mechanism

Upon delivery, the instrument is configured for automatic login into Windows XP. This mechanism must be disabled if the instrument is operated in a network, since the default user name ("instrument") and the password normally are not identical to those of the network account.

To disable the autologin mechanism, proceed as follows:

- Open the XP start menu by means of <CTRL><ESC>.
- Select the menu item "RUN". A dialog box opens.
- Enter the command "D:\USER\NO_AUTOLOGIN.REG" in the dialog box and confirm with <ENTER>.

The autologin mechanism is disabled. When the instrument is rebooted, a prompt for user name and password will appear before the instrument firmware is started.

Reenabling the Autologin Mechanism

To enable the autologin mechanism again, proceed as follows:

- Open the XP start menu by means of <CTRL><ESC>.
- Select the menu item "RUN". A dialog box opens.
- Enter the command "D:\USER\AUTOLOGIN.REG" in the dialog box and confirm with <ENTER>.

The autologin mechanism is reenabled and is active when the instrument is rebooted the next time.

Using Network Drives

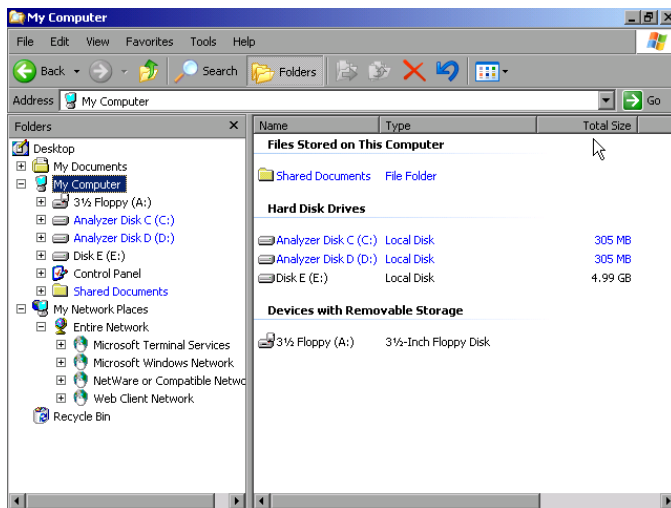

Mapping a network drive:

- Use the Windows key or the key combination <CTRL> <ESC> to call the Windows XP start menu.
- Click "Programs", "Accessories", "Windows Explorer" one after the other.
- Click the line "My Network Places" in the overview "Desktop".

An overview of the available network drives is displayed.

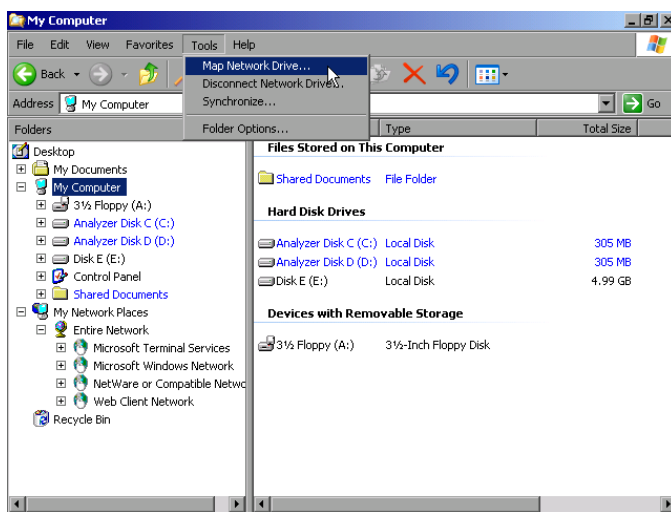

- Click "Tools" and then "Map Network Drive".

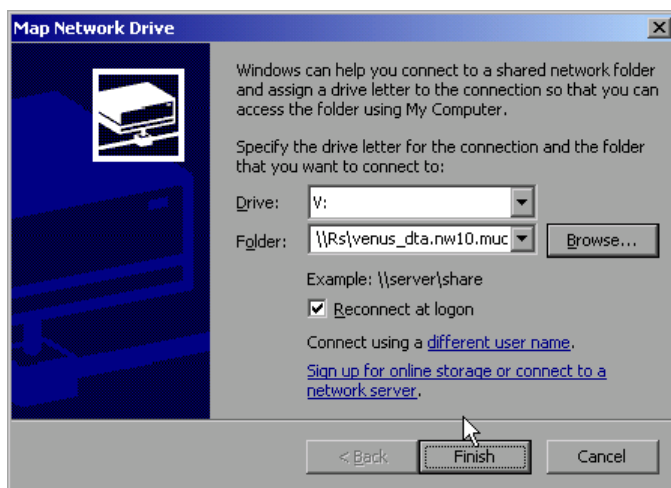

- Select the appropriate drive under "Drive:".
- With "Browse", open the list of available network paths in the network.
- Activate "Reconnect at Logon:" if the connection is to be set up automatically each time the instrument is started.
- Use "Finish" to connect the network path with the selected drive.



The user name and the password are queried. Then the drive will appear in the "All Directories" overview of the explorer.

Note: *Only those drives in the network for which the user has the appropriate access right can be connected.*

Disconnecting a network drive:

- Click "Tools" in the Explorer and then "Disconnect Network Drive".
- Select the drive to be disconnected under "Network Drive:".
- Disconnect the drive using "OK". The security prompt must be answered with "Yes".

Printing on a Network Printer

Note:

The following dialogs may be operated both via the front panel and via a mouse and PC keyboard (for further information see the sections "Connection of a Mouse" and "Connection of a Keyboard"). The mouse and the PC keyboard are indispensable for the configuration of network printers.

A new printer is installed via the *INSTALL PRINTER* softkey in the *HCOPY* menu.

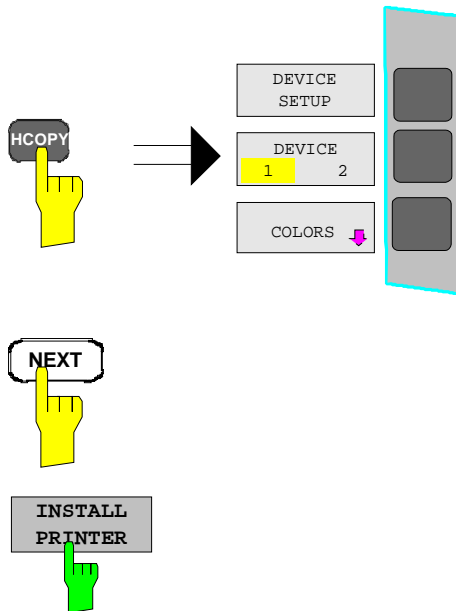

- Press the *HCOPY* key.
The *HCOPY* menu will be opened.

- Call up the lateral menu via the *NEXT* key.

- Open the *Printers and Faxes* dialog with *INSTALL PRINTER*.

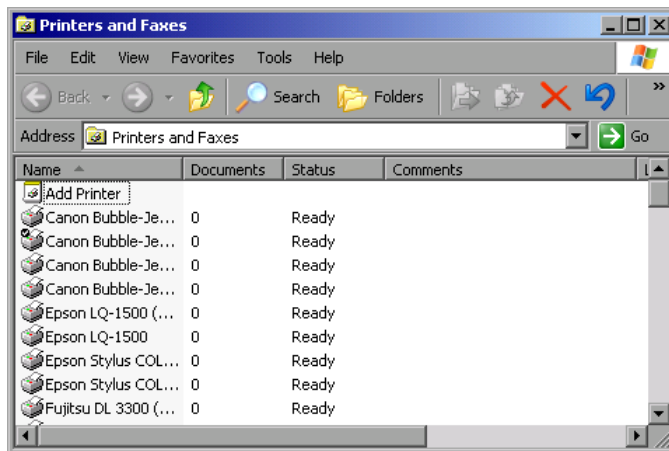

- Select the entry *Add Printer* in the selection list using the spinwheel.
- Highlight the entry with *CURSOR RIGHT* and confirm the selection by pressing *ENTER* or the spinwheel.
The *Add Printer Wizard* will be displayed.



- Select *NEXT* with the spinwheel and confirm by pressing the spinwheel.

The selection *Local or Network Printer* will be displayed.

In the following example, an HP Laserjet 5 printer will be installed as the network printer. The Add Printer Wizard has already been opened according to the information described in the section "Starting the Add Printer Wizard".

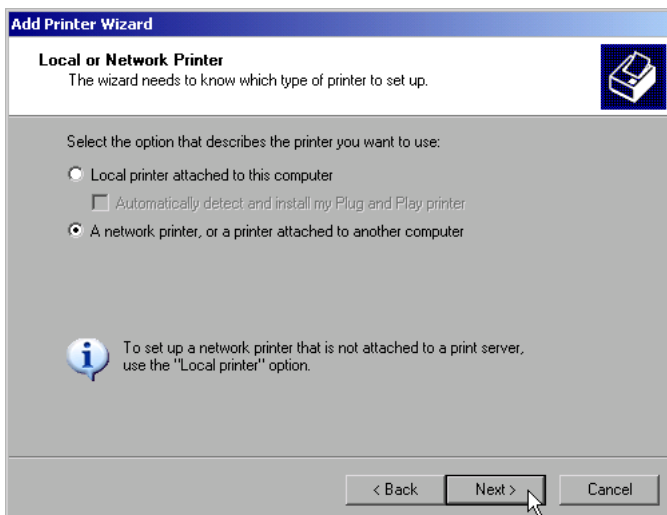

- To select a network printer, click the line "A network printer or a printer attached to another computer".

Then continue with "Next" .

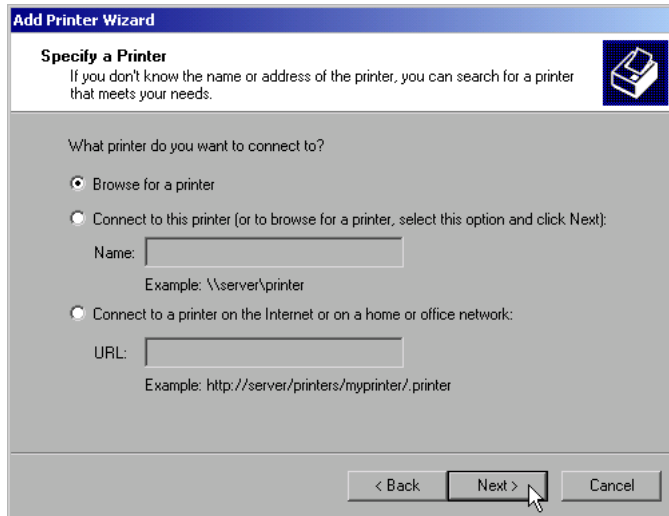

- First click "Browse for a printer" and then "Next" .

The selection of shared printers will appear.

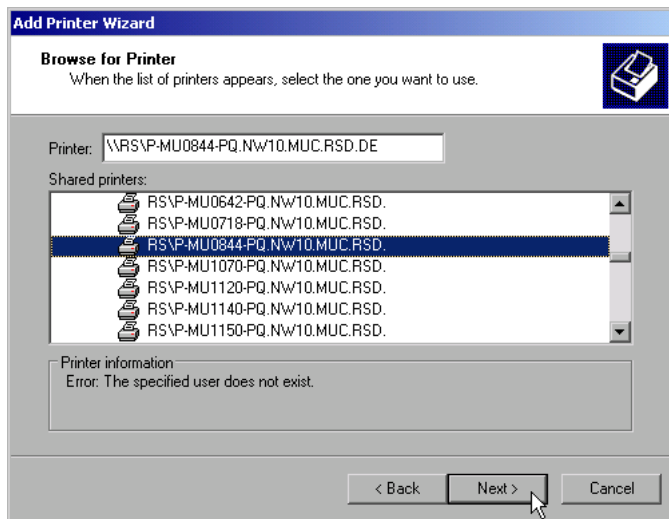

- Highlight printer and select with "OK".

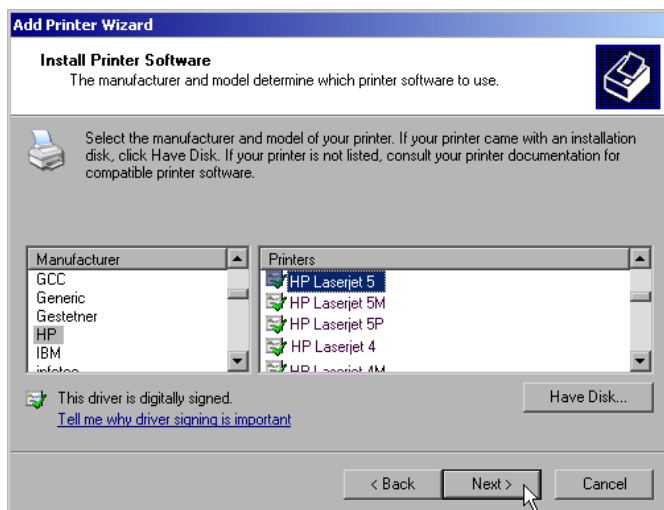

- Confirm the following request to install a suitable printer driver using "OK".

The selection of printer drivers will be displayed.

The manufacturers are displayed in the left-hand table and the available printer drivers in the right-hand table.

- First highlight the manufacturer in the selection list "Manufacturers" and then the printer driver in the selection list "Printers".

Note:

If the desired printer type does not appear in this list, the driver has not yet been installed in the instrument. In this case, click the "HAVE DISK" button. A request to insert a disk with the corresponding printer driver will appear. Then click "OK" and select the desired printer driver.

- Click "Next".

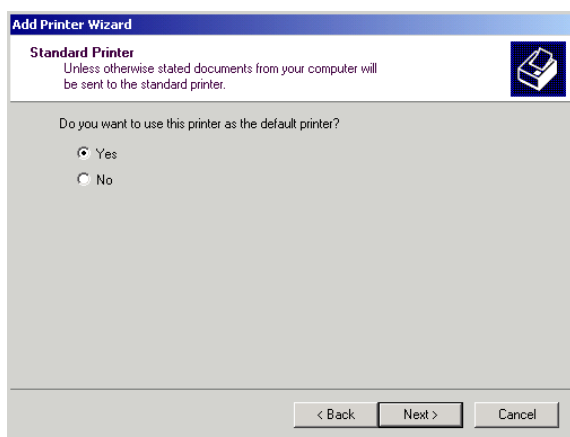

If one or several printers have already been installed, the query of whether the printer installed so far is to be selected as the default printer for the Windows XP applications will be displayed. "No" is preset.

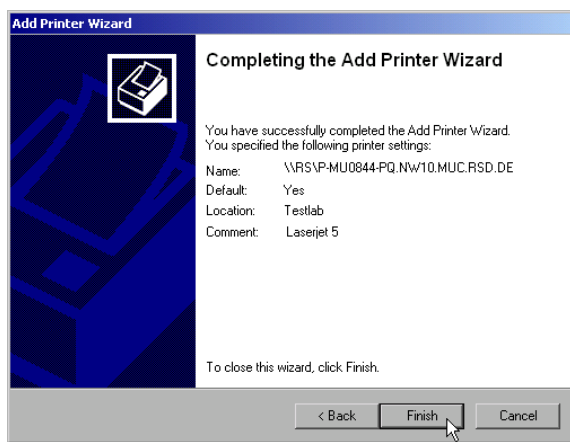

- Start the installation of the printer driver with "Finish".

Finally, the instrument still has to be configured for printout via this printer with the softkeys DEVICE SETUP and DEVICE 1/2 in the main hardcopy menu (see section "Selecting a Printer").

Sharing Directories (only for Microsoft Networks)

Data on the instrument can be made available for other computers if directories are shared. Sharing directories is only possible in the MICROSOFT network.

Sharing is a property of a file or directory. To allow sharing, proceed as follows:

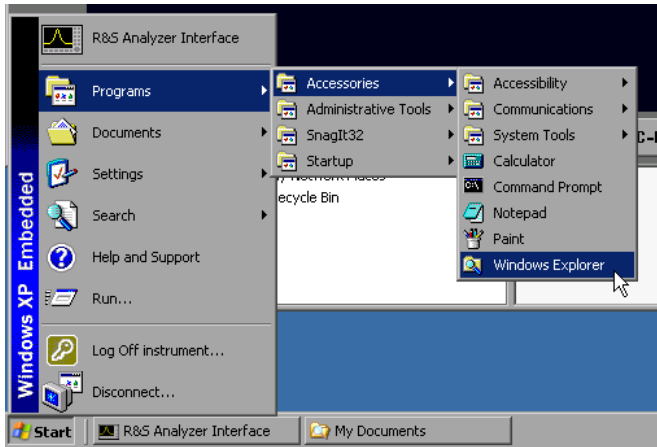

- Open the Windows start menu using the Windows key or <CTRL><ESC>.
- Open the Windows Explorer by clicking *Programs - Accessories - Windows Explorer*.

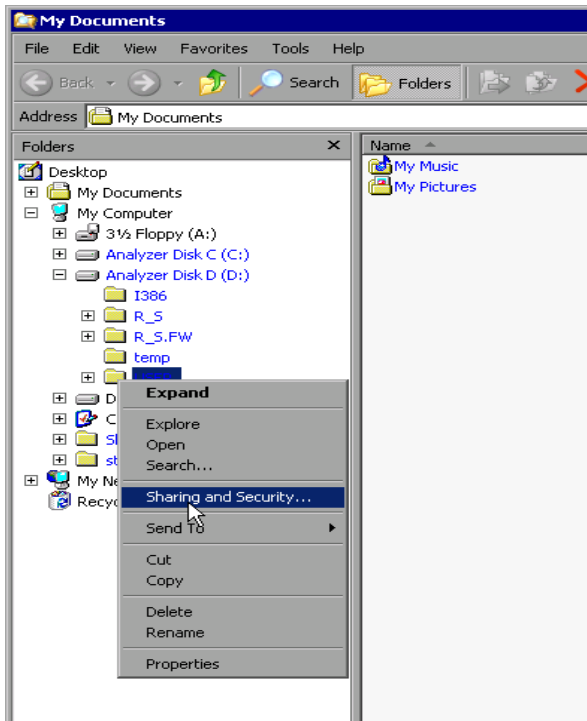

- Click the desired folder with the right mouse key.
- Click *Sharing and Security*.

The dialog to share the directories will be opened.

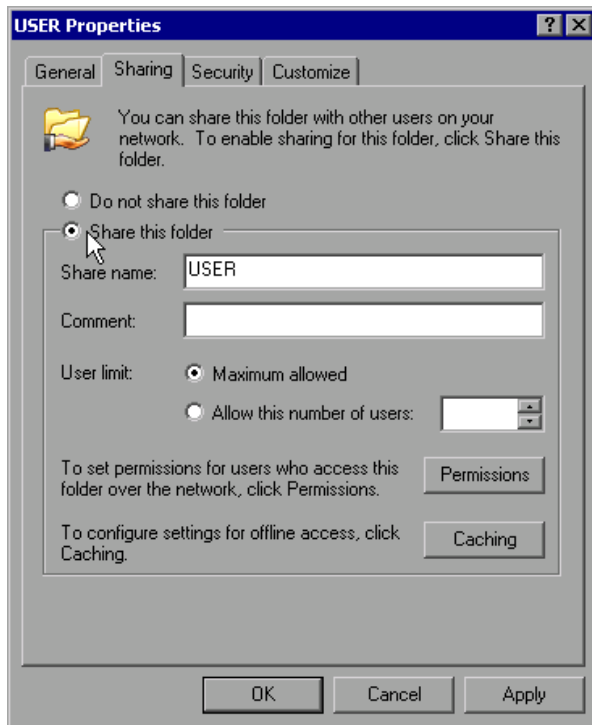

- Click *Share this folder*.
- The following settings can optionally be changed:
 - Share name:*
the name under which the directory appears in the Explorer
 - Comment:*
a comment regarding the shared directory
 - User Limit:*
the number of users that may access the directory at the same time
 - Permissions:*
the rights of the users (read only, read and write, all)
 - Caching:*
local buffering of directory contents for fast access
- Confirm settings with *OK*.

The drive is shared and this is shown in the Explorer by a hand under the directory symbol:



Remote Monitoring of R&S FSP via XP Remote Desktop

Introduction

In production test and measurements, the question of how to centrally monitor measuring instruments that are used for remote servicing/diagnostics is often arises. With the remote desktop of Windows XP, the new Spectrum Analyzer Family R&S FSP offers ideal preconditions for use in production:

- Access to operating functions via virtual front panel (*soft front panel*)
- Printout of measurement results directly from the controller
- Storing measurement data to the hard disk of the controller

The analyzer is connected via LAN. XP also supports the connection via data transmission (via modem). This section describes the configuration of R&S FSP and the remote desktop client of the control PC. For details on setting up the data transmission link, see relevant XP literature.

Configuration of R&S FSP for Using Remote Desktop

The following steps are required to allow an external PC access to the desktop of the R&S FSP.

1. Determine the IP configuration of the network link:

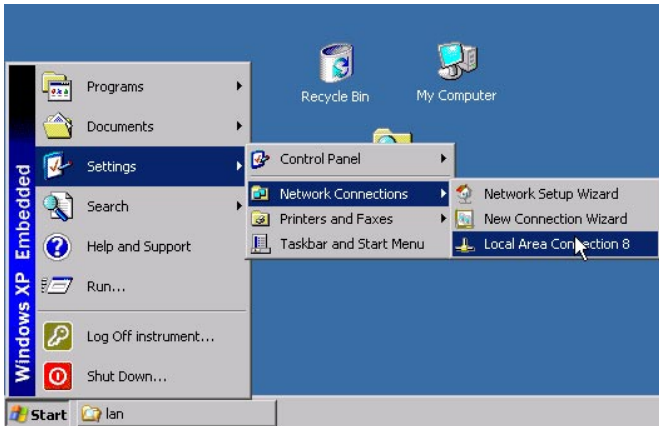

- Open the Windows XP start menu using the Windows key or *CTRL-ESC*.
- Click *Settings - Network Connections - Local Area Connection*.

The *Local Area Connection Status* dialog will be opened.

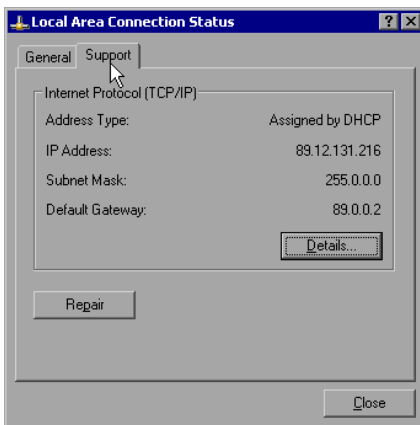

- Click the *Support* tab.

The current TCP/IP configuration will be displayed.

If the entry "Assigned by DHCP" is displayed in the *Address Type* field, continue with step 2 (Installing a fixed IP address...)

It would otherwise be sufficient to note the IP address and to continue with step 3 (Enabling the R&S FSP...)

2. Install a fixed IP address for the TCP/IP protocol as described in the Section "Configuration of Available Network Protocols (TCP/IP Protocol)".

Note:

Operation with a fixed IP address is strongly recommended.

When a DHCP server is used, a new IP address (which has to be determined first) will be assigned any time the instrument is restarted. For this reason, a DHCP server would not be suitable for use for detached operation of the R&S FSP.

3. Enable the R&S FSP for operation with the remote desktop.

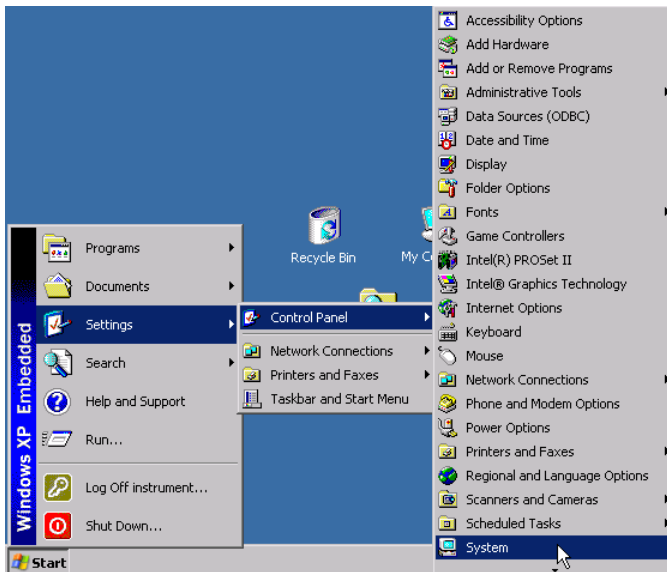

- Press the Windows key or <CTRL><ESC>.
- The Windows start menu will be opened.
- Select Settings - Control Panel - System.

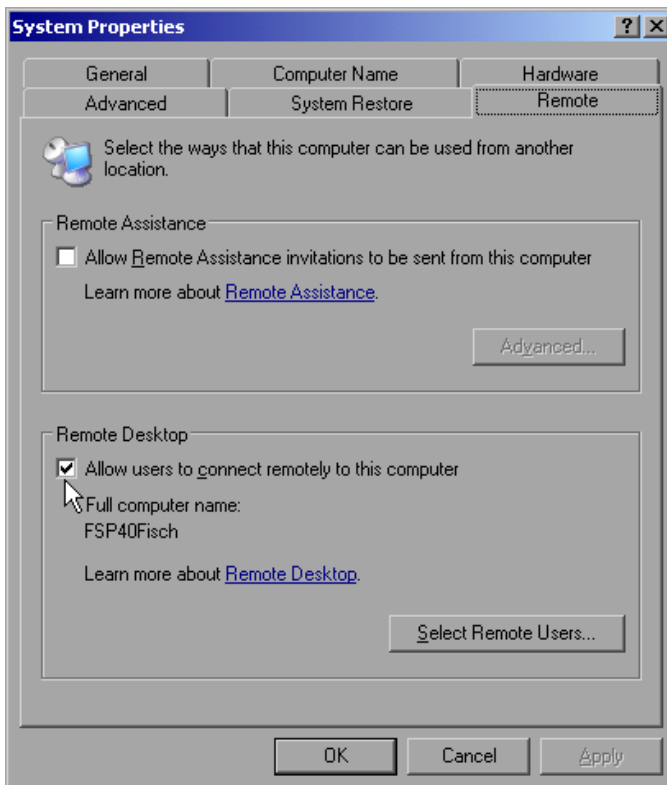

- Select the *Remote* tab.
- In the *Remote Desktop* field, tick the box in front of *Allow users to connect remotely to this computer*.
- If required, select the users installed on the R&S FSP who are to also have access to the R&S FSP via remote desktop in the *Select Remote Users...* dialog.

Note:

The user account under which the configuration is to be performed is automatically enabled for remote desktop.

- Confirm setting with *OK*.

The R&S FSP is therefore ready for setting up the connection with the remote desktop of the controller.

Configuration of Controller

A precondition for the operation of the remote desktop is the availability of the TCP/IP protocol on the controller and the installation of the remote desktop client.

Note:

For Windows XP, the remote desktop client is part of the operating system and available under Start - Programs - Accessories - - Communications - Remote Desktop Connection.

For other Windows versions, Microsoft offers the remote client as a separate program package for subsequent installation.

The settings on the remote desktop client of the controller must be made prior to setting up the connection with the R&S FSP. The following steps are required:

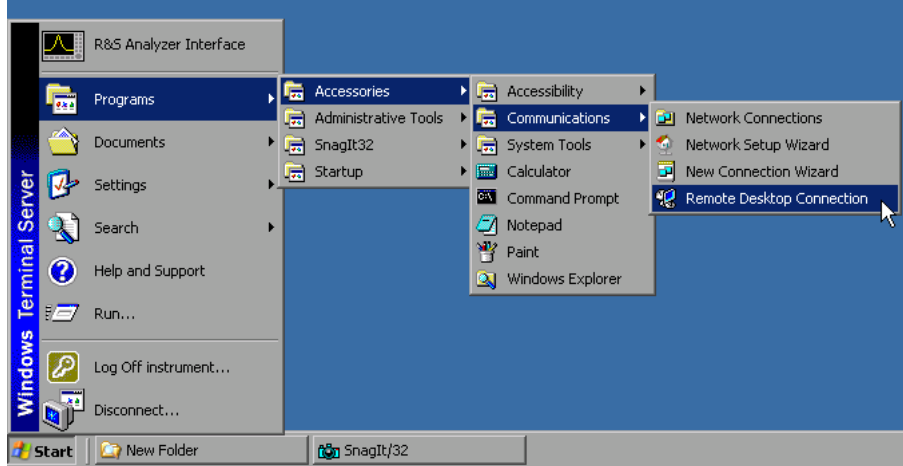

- Press the Windows key or <CTRL><ESC>.
- Select Programs - Accessories - Communications - Remote Desktop Connection.

The Remote Desktop Connection screen will be opened.

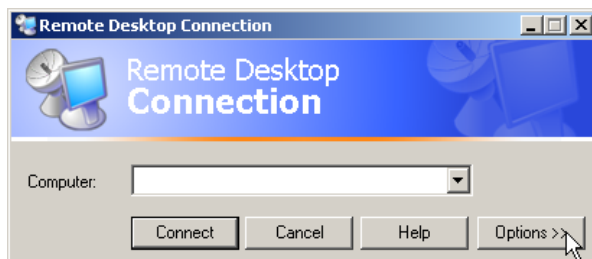

- Click the *Options >>* button.

The tabs with the configuration data will be opened.

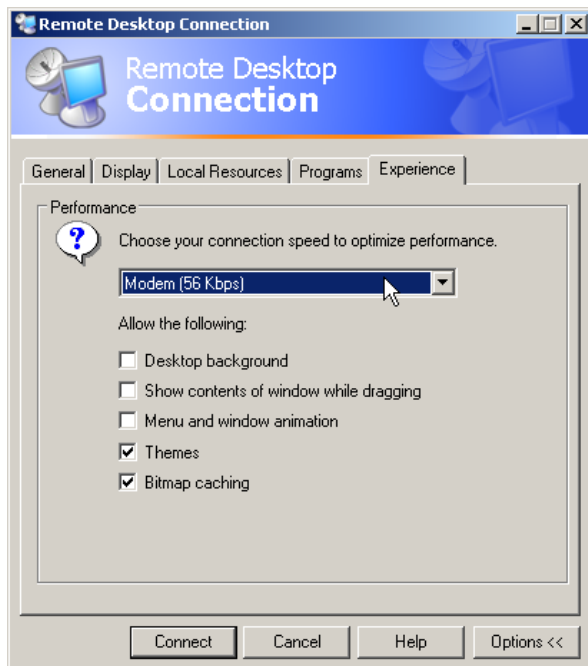

- Select the *Experience* tab.
The speed of setting up the connection will be selected and optimized.
- Click the selection list under *Choose your connection speed to optimize performance*.

The list of available configurations will be opened.

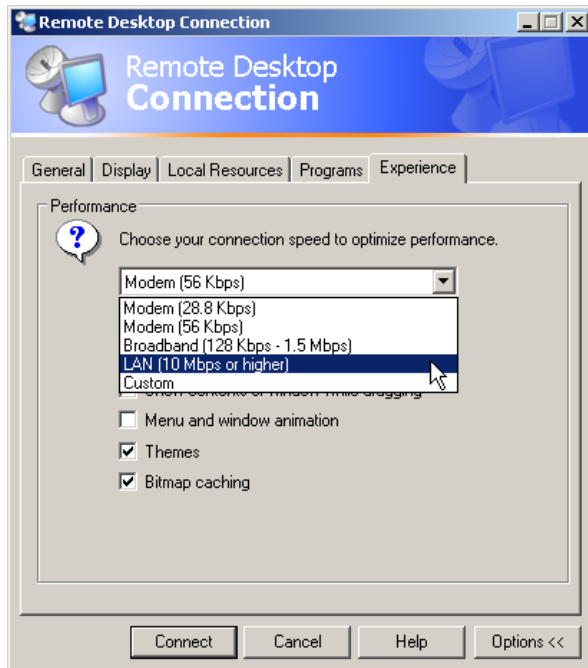

- Select the suitable connection (in the example LAN (10 Mbps or higher)).

Different boxes in the list below are activated depending on the selection and depending on the performance of the connection.

- To improve the performance, the entries "Desktop background", "Show Contents of Window while dragging" and "Menu and Window animation" can be switched off.
- Click the *Local Resources* tab. The tab to share printers, local drives and serial interfaces will be opened.



- Click the box in front of *Disk drives* if drives of the controller are to be accessed from the R&S FSP (e.g. to save settings or to copy files from the controller to the R&S FSP). Windows XP will then map the drives of the controller like network drives on the R&S FSP.
- Click the box in front of *Printers* if printers connected to the controller are to be used from the R&S FSP.
- Do not change the other settings.
- Click the *Display* tab. The configuration of the representation of the R&S FSP screen on the controller will be opened.

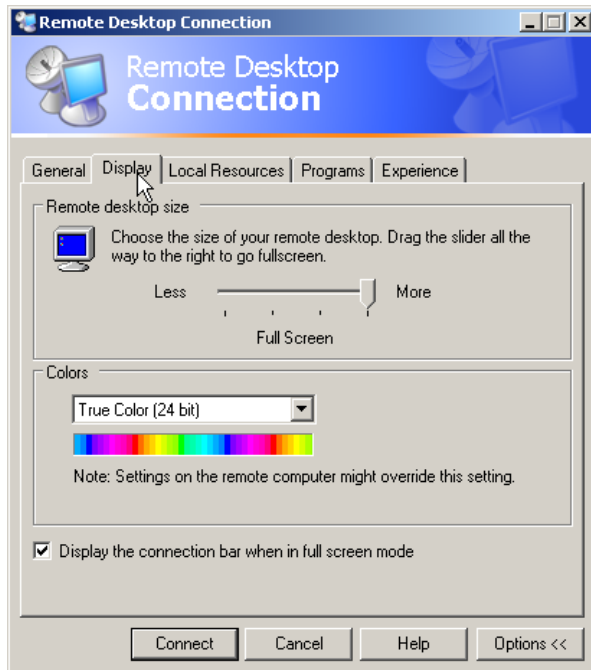

- The size of the R&S FSP window on the desktop of the controller can be changed by means of the slider. The default setup is full screen.
- Do not change the colour depth.
- *Display the connection bar when in full screen mode:*

If this box is checked, a bar will appear at the top screen margin. This bar displays the network address of the R&S FSP and can be used to reduce, minimize or to close the window.

If the box is not checked, a return from the R&S FSP screen to the controller desktop in the full-screen mode is possible only if "Disconnect" is selected in the start menu:

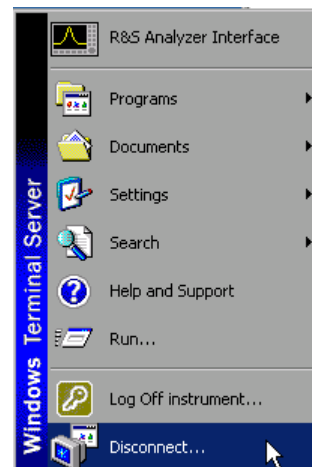

Setting up the Connection with the R&S FSP

After configuration of the remote desktop client, the connection with the R&S FSP has to be set up.

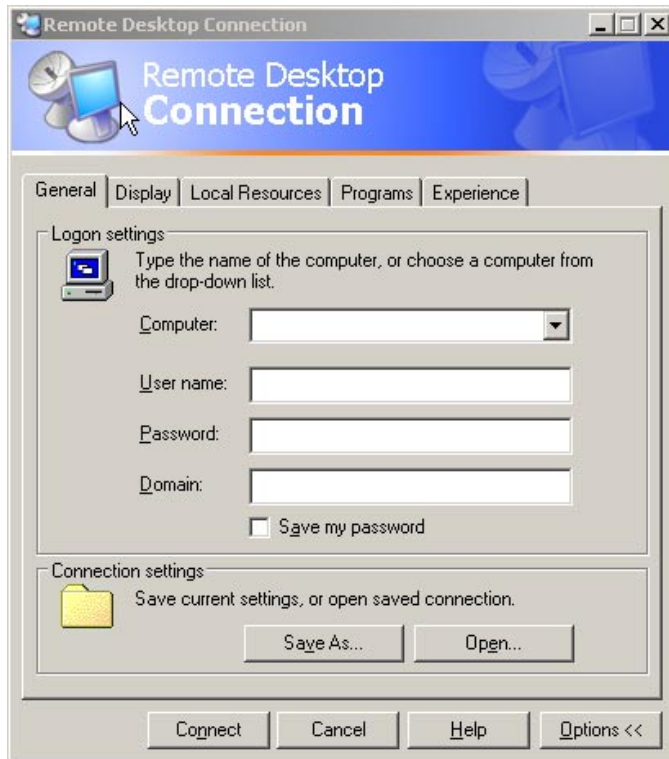

- Click the *General* tab. The connection information will be entered.
- Enter the IP address of the R&S FSP in the *Computer* field.
- The information can be stored via the *Save As...* button for the next time. With the *Open...* button, it is possible to load an existing configuration again.
- Press the *Connect* button. The connection will be set up.

Note:

If the entry *Disk Drives* is active in the *Local Resources* tab, a warning is issued that the drives will be shared for access from the R&S FSP:



Confirm the warning with OK. The setup will be continued.

The R&S FSP screen will appear on the controller screen with the request to log in. To allow remote control of the R&S FSP, the following steps have to be carried out:



- Enter user name "instrument" and password "instrument".

The R&S FSP screen will be opened in a few moments.

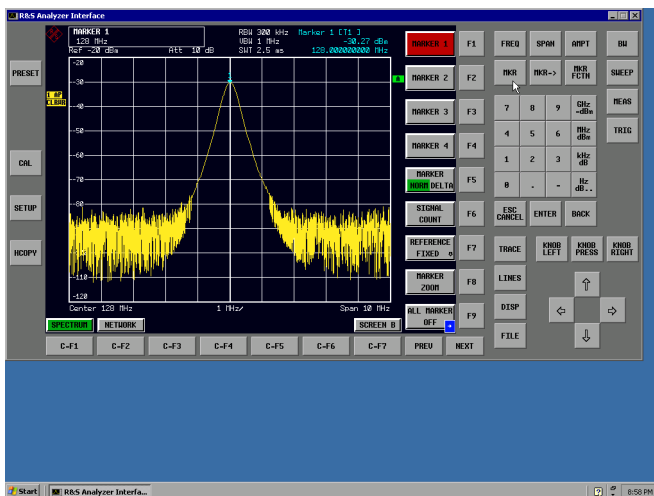
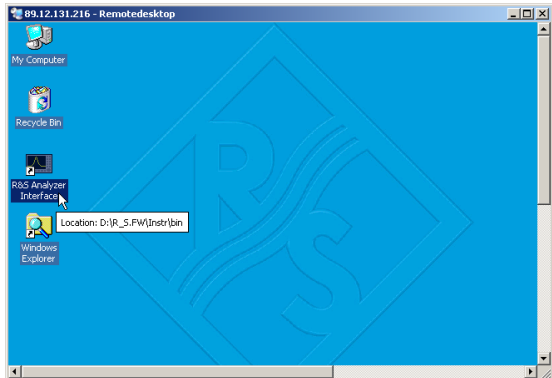
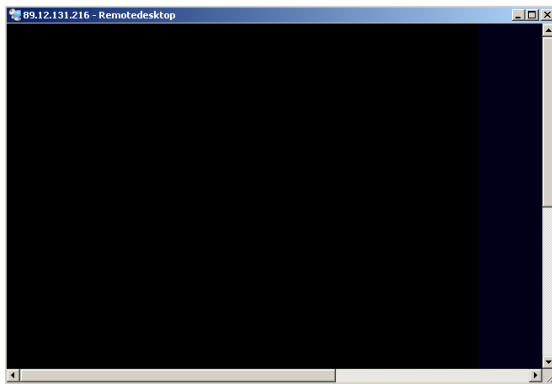

If the screen is dark or if a dark rectangle appears in the upper left corner, the R&S FSP firmware must be restarted in order to recognize the modified screen resolution. In this case:

- Press <ALT><F4>. The R&S FSP firmware will be shut down. This may last for several seconds.

- Double-click the entry *R&S Analyzer Interface*.

The firmware will restart and will automatically open the *Soft Frontpanel*, i.e. the user interface in which all front panel buttons and the spinwheel are shown.

- If the R&S FSP application is directly displayed after setup, shutdown and restart can be omitted.

- All hardkeys, softkeys and hotkeys can be operated with the mouse.
- The spinwheel is implemented by *KNOB LEFT*, *KNOB RIGHT* and *KNOB PRESS*.
- The XP start menu is available if the remote desktop window is enlarged to full size.

Interruption and Re-setup of Remote Desktop Connection with the R&S FSP

The connection to the R&S FSP can be interrupted any time if the remote desktop window is connected to the controller.

To reestablish the connection, the setup with the R&S FSP only has to be performed again as described in the section "Setting up the Connection with the R&S FSP". The R&S FSP will then maintain its state in case of an interruption with a subsequent re-setup.

When the connection is set up with the controller, the login entry will be displayed on the R&S FSP screen. If the login procedure is carried out successfully, the message that a different user has assumed control of the instrument and that the connection was therefore cleared will be displayed on the screen of the controller.

Switching off the R&S FSP from the Controller

The R&S FSP can be switched off per remote control. For this purpose, proceed as follows:

1. Click the R&S FSP soft front panel and close the application with <ALT><F4> .
2. Click the desktop and press <ALT><F4>.

A confirmation query with the warning that the instrument cannot be switched on again via remote control is displayed with the query to continue the shutdown process.
3. Answer the confirmation query with YES.

The connection to the controller will then be cleared and the R&S FSP will be switched off.

Remote Data Transfer with TCP/IP Services

The protocol TCP/IP allows the transfer of files between different computer systems. This requires a program running on the two computers that controls this data transfer. It is not necessary that the same operating or file system is used by both computers. For example, a file transfer between DOS/WINDOWS and UNIX is possible. One of the two partners must be configured as Host and the other one as Client. However, they may change their roles. Usually, the system which is able to perform several processes at the same time will play the host role. The file transfer program usually used under TCP/IP is FTP (File Transfer Protocol). An FTP host is installed as standard on the majority of UNIX systems.

If the TCP/IP services are installed, a terminal connection is possible using "Start" - "Programs" - "Accessories" - "Telnet" or a data transfer via FTP by means of "Start" - "Run" "ftp" - "OK". Thus all computer systems supporting these universal protocols can be addressed (UNIX, VMS, etc).

For further information, refer to the corresponding XP literature.

File Transfer via FTP

The total scope of functions and commands is described in the FTP literature. The following table therefore only contains the major functions:

Setting up the connection

Click "Start" and then "Run" in the task bar.

The DOS command

FTP

starts the program.

The command

OPEN <xx.xx.xx.xx>

sets up the connection.

xx.xx.xx.xx = IP address e.g. 89.0.0.13

Data transfer

The command

PUT <dateiname>

transfers the data to the target system.

The command

GET <dateiname>

transfers the data from the target system.

The command

TYPE B

transfers the data in BINARY format; no conversion takes place.

The command

TYPE A

transfers the data in ASCII format, converting control characters so that text files can also be read on the target system.

Examples:

```
PUT C:\AUTOEXEC.BAT
```

sends the file AUTOEXEC.BAT to the target system.

```
LCD DATA
```

changes the current directory on the local machine to subdirectory DATA

```
CD SETTING
```

changes to the subdirectory SETTING on the target system

dateiname= File name e.g. DATA.TXT

Changing the directories

The command

```
LCD <path>
```

changes the directory on the local machine as with DOS.

The command

```
LDIR
```

shows the directory contents on the local machine.

These commands refer to the file system of the FSP. If the `L` is omitted ahead of the commands, they apply to the target system.

RSIB Protocol

The instrument is equipped with an RSIB protocol as standard, which allows the instrument to be controlled by means of Visual C++ and Visual Basic programs, but also by means of the Windows applications WinWord and Excel as well as National Instruments LabView, LabWindows/CVI and Agilent VEE. The control applications run on an external computer in the network.

A UNIX operating system can be installed on an external computer in addition to a Windows operating system. In this case, the control applications are created either in C or C++. The supported UNIX operating systems include:

- Sun Solaris 2.6 Sparc Station
- Sun Solaris 2.6 Intel Platform
- Red Hat Linux 6.2 x86 Processors

Remote Control via RSIB Protocol

Windows Environment

To access the measuring instruments via the RSIB protocol, the file `RSIB32.DLL` must be copied to the Windows `system32` directory or to the directory of the control applications. For 16-bit applications, the file `RSIB.DLL` must be additionally copied to the directories mentioned. The files `RSIB.DLL` and `RSIB32.DLL` are included on the instrument in directory `D:\R_S\Instr\RSIB`.

For the different programming languages, there are files available that contain the declarations of the DLL functions and the definition of the error codes.

Visual Basic (16 bit):	'RSIB.BAS'	(D:\R_S\Instr\RSIB)
Visual Basic (32 bit):	'RSIB32.BAS'	(D:\R_S\Instr\RSIB)
C:/C++:	'RSIB.H'	(D:\R_S\Instr\RSIB)

For C/C++: programs, import libraries are additionally available.

Import library for RSIB.DLL:	RSIB.LIB'	(D:\R_S\Instr\RSIB)
Import library for RSIB32.DLL:	RSIB32.LIB'	(D:\R_S\Instr\RSIB)

The control is performed using the Visual C++ or Visual Basic programs WinWord, Excel, LabView, LabWindows/CVI or Agilent VEE. Every application that can load a DLL is able to use the RSIB protocol. The programs use the IP address of the instrument or its *host name* to set up the connection.

Via VisualBasic: `ud = RSDLLibfind ("82.1.1.200", ibsta, iberr, ibcntl)`

Return to manual operation is possible via the front panel (*LOCAL* key) or via the RSIB protocol:

Via RSIB: `ud = RSDLLibloc (ud, ibsta, iberr, ibcntl);`
 `or`
 `ud = RSDLLibonl (ud, 0, ibsta, iberr, ibcntl);`

UNIX Environment

To access the measuring equipment via the RSIB interface, copy the `librsib.so.X.Y` file to a directory for which the control application has read rights. `X.Y` in the file name indicates the version number of the library, for example `1.0`.

The `librsib.so.X.Y` library is created as a *shared library*. The applications using the library need not consider its version. They simply link the library with the `lrsib` option. The following instructions have to be observed so that linking can be successfully performed and the library can be found during program execution:

File link:

- Use the operating system command `ln` to create a file with the link name `librsib.so` and pointing to `librsib.so.X.Y` in a directory for which the control application has read rights. Example:

```
$ ln -s /usr/lib/librsib.so.1.0 /usr/lib/librsib.so
```

Linker options for creating applications:

- `-lrsib`: import library
- `-Lxxx`: path information where the import library can be found. This is where the above file link has been created. Example: `-L/usr/lib`.

Additional linker options for creating applications (only under Solaris):

- `-Rxxx`: path information where the library is searched for during the program run:
`-R/usr/lib`.

Run-time environment:

- Set environment variable `LD_RUN_PATH` to the directory in which the file link has been created. This is necessary only if `librsib.so` cannot be found in the default search path of the operating system and the `-R` linker option (only Solaris) was not specified.

For C/C++ programming, the declarations of the library functions and the definition of error codes are contained in:

```
C/C++:          'RSIB.H'          (D:\R_S\Instr\RSIB)
```

RSIB Interface Functions

This chapter lists all functions of the DLL "RSIB.DLL" or "RSIB32.DLL" or "librsib.so", which allow control applications to be produced.

Overview of Interface Functions

The library functions are adapted to the interface functions of National Instruments for GPIB programming. The functions supported by the libraries are listed in the following table.

Function	Description
RSDLLibfind()	Provides a handle for access to a device.
RSDLLibwrt()	Sends a zero-terminated string to a device.
RSDLLilwrt()	Sends a certain number of bytes to a device.
RSDLLibwrtf()	Sends the contents of a file to a device.
RSDLLibrd()	Reads data from a device into a string.
RSDLLilrd()	Reads a certain number of bytes from a device.
RSDLLibrdf()	Reads data from a device into a file.
RSDLLibtmo()	Sets timeout for RSIB functions.
RSDLLibsre()	Switches a device to the local or remote state.
RSDLLibloc()	Temporarily switches a device to the local state.
RSDLLibeot()	Enables/disables the END message for write operations.
RSDLLibrsp()	Performs a serial poll and provides the status byte.
RSDLLibonl()	Sets the device online/offline.
RSDLLTestSrqr()	Checks whether a device has generated an SRQ.
RSDLLWaitSrqr()	Waits until a device generates an SRQ.
RSDLLSwapBytes	Swaps the byte sequence for binary numeric display (only required for non-Intel platforms).

Variables `ibsta`, `iberr`, `ibcntl`

As with the National Instrument interface, the successful execution of a command can be checked by means of the variables `ibsta`, `iberr` and `ibcntl`. For this purpose, all RSIB functions are assigned references to these three variables.

Status word - `ibsta`

The status word `ibsta` provides information on the status of the RSIB interface. The following bits are defined:

Bit designation	Bit	Hex code	Description
ERR	15	8000	Is set when an error has occurred on calling a function. If this bit is set, <code>iberr</code> contains an error code that specifies the error in greater detail.
TIMO	14	4000	Is set when a timeout has occurred on calling a function.
CMPL	8	0100	Is set if the response of the GPIB parser has been read out completely. If a parser response is read out with the function <code>RSDLLi1rd()</code> and the length of the buffer is insufficient for the answer, the bit will be cleared.

Error variable - `iberr`

If the ERR bit (8000h) is set in the status word, `iberr` contains an error code which allows the error to be specified in greater detail. Extra error codes are defined for the RSIB protocol, independent of the National Instruments interface.

Error	Error code	Description
IBERR_CONNECT	2	Setup of the connection to the measuring instrument has failed.
IBERR_NO_DEVICE	3	A function of the interface has been called with an illegal device handle.
IBERR_MEM	4	No empty memory available.
IBERR_TIMEOUT	5	Timeout has occurred.
IBERR_BUSY	6	The RSIB protocol is blocked by a function that is still running.
IBERR_FILE	7	Error when reading or writing to a file.
IBERR_SEMA	8	Error upon creating or assigning a semaphore (only under UNIX).

Count variable - `ibcntl`

The variable `ibcntl` is updated with the number of transferred bytes each time a read or write function is called.

Description of Interface Functions

RSDLLibfind()

The function provides a handle for access to the device with the name udName.

VB format: Function RSDLLibfind (ByVal udName\$, ibsta%, iberr%, ibcntl&) As Integer

C format: short WINAPI RSDLLibfind(char far *udName, short far *ibsta, short far *iberr, unsigned long far *ibcntl)

C format (UNIX): short RSDLLibfind(char *udName, short *ibsta, short *iberr, unsigned long *ibcntl)

Parameters: udName IP address of device

Example: ud = RSDLLibfind ("89.10.38.97", ibsta, iberr, ibcntl)

The function must be called prior to all other functions of the interface.

As return value, the function provides a handle that must be indicated in all functions for access to the device. If the device with the name udName is not found, the handle has a negative value.

RSDLLibwrt

This function sends data to the device with the handle ud.

VB format: Function RSDLLibwrt (ByVal ud%, ByVal Wrt\$, ibsta%, iberr%, ibcntl&) As Integer

C format: short WINAPI RSDLLibwrt(short ud, char far *Wrt, short far *ibsta, short far *iberr, unsigned long far *ibcntl)

C format (UNIX): short RSDLLibwrt(short ud, char *Wrt, short *ibsta, short *iberr, unsigned long *ibcntl)

Parameters: ud Device handle
Wrt String sent to the device.

Example: RSDLLibwrt(ud, "SENS:FREQ:STAR?", ibsta, iberr, ibcntl)

This function allows setting and query commands to be sent to the measuring instruments. Whether the data is interpreted as a complete command can be set using the function RSDLLibeot().

RSDLLilwrt

This function sends Cnt bytes to a device with the handle ud.

VB format: Function RSDLLilwrt (ByVal ud%, ByVal Wrt\$, ByVal Cnt&, ibsta%, iberr%, ibcntl&) As Integer

C format: short WINAPI RSDLLilwrt(short ud, char far *Wrt, unsigned long Cnt, short far *ibsta, short far *iberr, unsigned long far *ibcntl)

C format (UNIX): short RSDLLilwrt(short ud, char *Wrt, unsigned long Cnt, short *ibsta, short *iberr, unsigned long *ibcntl)

Parameters: ud Device handle
Wrt String sent to the GPIB parser.
Cnt Number of bytes sent to the device.

Example: RSDLLilwrt (ud, '.....', 100, ibsta, iberr, ibcntl)

Like RSDLLibwrt() this function sends data to a device. The only difference is that binary data can be sent as well. The length of the data is not determined by a zero-terminated string, but by the indication of Cnt bytes. If the data is to be terminated with EOS (0Ah), the EOS byte must be appended to the string.

RSDLLibwrtf

This function sends the contents of a file `file$` to the device with the handle `ud`.

VB format: Function RSDLLibwrtf (ByVal ud%, ByVal file\$, ibsta%, iberr%, ibcntl&) As Integer

C format: short WINAPI RSDLLibwrt(short ud, char far *Wrt, short far *ibsta, short far *iberr, unsigned long far *ibcntl)

C format (UNIX): short RSDLLibwrt(short ud, char *Wrt, short *ibsta, short *iberr, unsigned long *ibcntl)

Parameters: ud Device handle
file File whose contents is sent to the device.

Example: RSDLLibwrtf(ud, "C:\db.sav", ibsta, iberr, ibcntl)

This function allows setting and query commands to be sent to the measuring instruments. Whether the data is interpreted as a complete command can be set using the function RSDLLibeot().

RSDLLibrd()

The function reads data from the device with the handle `ud` into the string `Rd`.

VB format: Function RSDLLibrd (ByVal ud%, ByVal Rd\$, ibsta%, iberr%, ibcntl&) As Integer

C format: short WINAPI RSDLLibrd(short ud, char far *Rd, short far *ibsta, short far *iberr, unsigned long far *ibcntl)

C format (UNIX): short RSDLLibrd(short ud, char *Rd, short *ibsta, short *iberr, unsigned long *ibcntl)

Parameters: ud Device handle
Rd String to which the read data is copied.

Example: RSDLLibrd (ud, Rd, ibsta, iberr, ibcntl)

This function fetches the responses of the GPIB parser to a query.

In the case of Visual Basic programming, a string of sufficient length must be generated beforehand. This can be done during the definition of the string or using the command `Space$()`.

Generation of a string of the length 100: - Dim Rd as String * 100
 - Dim Rd as String
 Rd = Space\$(100)

RSDLLilrd

This function reads `Cnt` bytes from the device with the handle `ud`.

VB format: Function RSDLLilrd (ByVal ud%, ByVal Rd\$, ByVal Cnt&, ibsta%, iberr%, ibcntl&) As Integer

C format: short WINAPI RSDLLilrd(short ud, char far *Rd, unsigned long Cnt, short far *ibsta, short far *iberr, unsigned long far *ibcntl)

C format (UNIX): short RSDLLilrd(short ud, char *Rd, unsigned long Cnt, short *ibsta, short *iberr, unsigned long *ibcntl)

Parameters: ud Device handle
cnt Maximum number of bytes copied from the DLL into the target string `Rd`.

Example: RSDLLilrd (ud, RD, 100, ibsta, iberr, ibcntl)

Like the function `RSDLLibrd()`, this function reads data from a device. The only difference is that in this case the maximum number of bytes to be copied to the target string `Rd` can be indicated by means of `Cnt`. This function prevents writing beyond the end of the string.

RSDLLibrdf()

Reads data from the device with the handle `ud` into the file `file`.

VB format: Function RSDLLibrdf (ByVal ud%, ByVal file\$, ibsta%, iberr%, ibcntl&) As Integer

C format: short WINAPI RSDLLibrdf(short ud, char far *file, short far *ibsta, short far *iberr, unsigned long far *ibcntl)

C format (UNIX): short RSDLLibrdf(short ud, char *file, short *ibsta, short *iberr, unsigned long *ibcntl)

Parameters: ud Device handle
file File to which the read data is written.

Example: RSDLLibrdf (ud, "c:\db.sav", ibsta, iberr, ibcntl)

The file name may as well include a drive or path specification.

RSDLLibtmo

This function defines the timeout for a device. The default value for the timeout is set to 5 seconds.

VB format: Function RSDLLibtmo (ByVal ud%, ByVal tmo%, ibsta%, iberr%, ibcntl&) As Integer

C format: void WINAPI RSDLLibtmo(short ud, short tmo, short far *ibsta, short far *iberr, unsigned long far *ibcntl)

C format (UNIX): short RSDLLibtmo(short ud, short tmo, short *ibsta, short *iberr, unsigned long *ibcntl)

Parameters: ud Device handle
tmo Timeout in seconds

Example: RSDLLibtmo (ud, 10, ibsta, iberr, ibcntl)

RSDLLibsre

This function sets the device to the 'LOCAL' or 'REMOTE' state.

VB format: Function RSDLLibsre (ByVal ud%, ByVal v%, ibsta%, iberr%, ibcntl&) As Integer

C format: void WINAPI RSDLLibsre(short ud, short v, short far *ibsta, short far *iberr, unsigned long far *ibcntl)

C format (UNIX): short RSDLLibsre(short ud, short v, short *ibsta, short *iberr, unsigned long *ibcntl)

Parameters: ud Device handle
v State of device

0 - local

1 - remote

Example: RSDLLibsre (ud, 0, ibsta, iberr, ibcntl)

RSDLLibloc

This function temporarily switches the device to the 'LOCAL' state.

VB format: Function RSDLLibloc (ByVal ud%, ibsta%, iberr%, ibcntl&) As Integer

C format: void WINAPI RSDLLibloc(short ud, short far *ibsta, short far *iberr, unsigned long far *ibcntl)

C format (UNIX): short RSDLLibloc(short ud, short *ibsta, short *iberr, unsigned long *ibcntl)

Parameter: ud Device handle

Example: RSDLLibloc (ud, ibsta, iberr, ibcntl)

After switchover to LOCAL state, the instrument can be manually operated via the front panel. On the next access to the instrument by means of one of the functions of the library, the instrument is switched again to the REMOTE state.

RSDLLibeot

This function enables or disables the END message after write operations.

VB format: Function RSDLLibeot (ByVal ud%, ByVal v%, ibsta%, iberr%, ibcntl&) As Integer

C format: void WINAPI RSDLLibsre(short ud, short v, short far *ibsta, short far *iberr, unsigned long far *ibcntl)

C format (UNIX): short RSDLLibsre(short ud, short v, short *ibsta, short *iberr, unsigned long *ibcntl)

Parameters: ud Device handle
v 0 - no END message
1 - send END message

Example: RSDLLibeot (ud, 1, ibsta, iberr, ibcntl)

If the END message is disabled, the data of a command can be sent with several successive calls of write functions. The END message must be enabled again before sending the last data block.

RSDLLibrsp

This function performs a serial poll and provides the status byte of the device.

VB format: Function RSDLLibrsp(ByVal ud%, spr%, ibsta%, iberr%, ibcntl&) As Integer

C format: void WINAPI RSDLLibrsp(short ud, char far* spr, short far *ibsta, short far *iberr, unsigned long far *ibcntl)

C format (UNIX): short RSDLLibrsp(short ud, char *spr, short *ibsta, short *iberr, unsigned long *ibcntl)

Parameters: ud Device handle
spr Pointer to status byte

Example: RSDLLibrsp(ud, spr, ibsta, iberr, ibcntl)

RSDLLibonl

This function switches the device to 'online' or 'offline' mode. When it is switched to 'offline' mode, the interface is released and the device handle becomes invalid. By calling RSDLLibfind again, the communication is set up again.

VB format: Function RSDLLibonl (ByVal ud%, ByVal v%, ibsta%, iberr%, ibcntl&) As Integer

C format: void WINAPI RSDLLibonl(short ud, short v, short far *ibsta, short far *iberr, unsigned long far *ibcntl)

C format: short RSDLLibonl(short ud, short v, short *ibsta, short *iberr, unsigned long *ibcntl)

Parameters:

ud	Device handle
v	Device state
	0 - local
	1 - remote

Example: RSDLLibonl(ud, 0, ibsta, iberr, ibcntl)

RSDLLTestSRQ

This function checks the status of the SRQ bit.

VB format: Function RSDLLTestSrq (ByVal ud%, Result%, ibsta%, iberr%, ibcntl&) As Integer

C format: void WINAPI RSDLLTestSrq(short ud, short far *result, short far *ibsta, short far *iberr, unsigned long far *ibcntl)

C format (UNIX): short RSDLLTestSrq(short ud, short *result, short *ibsta, short *iberr, unsigned long *ibcntl)

Parameters:

ud	Device handle
result	Reference to an integer value in which the library returns the status of the SRQ bit
	0 - no SRQ
	1 - SRQ active, device requests service

Example: RSDLLTestSrq (ud, result%, ibsta, iberr, ibcntl)

This function corresponds to the function RSDLLWaitSrq. The only difference is that RSDLLTestSRQ immediately returns the current status of the SRQ bit, whereas RSDLLWaitSrq waits for an SRQ to occur.

RSDLLWaitSrq

This function waits until the device triggers an SRQ with the handle `ud`.

VB format: Function RSDLLWaitSrq (ByVal ud%, Result%, ibsta%, iberr%, ibcntl&) As Integer

C format: void WINAPI RSDLLWaitSrq(short ud, short far *result, short far *ibsta, short far *iberr, unsigned long far *ibcntl)

C format (UNIX): short RSDLLWaitSrq(short ud, short *result, short *ibsta, short *iberr, unsigned long *ibcntl)

Parameters:

<code>ud</code>	Device handle
<code>result</code>	Reference to an integer value in which the library returns the status of the SRQ bit
	0 - No SRQ occurred during the timeout
	1 - SRQ occurred during the timeout

Example: RSDLLWaitSrq(ud, result, ibsta, iberr, ibcntl);

The function waits until one of the following two events occurs.

- The measuring instrument triggers an SRQ.
- No SRQ occurs during the timeout defined with `RSDLLibtmo()`.

RSDLLSwapBytes

This function changes the display of binary numbers on non-Intel platforms.

VB format: Not provided at present since it is required only on non-Intel platforms.

C format: void WINAPI RSDLLSwapBytes(void far *pArray, const long size, const long count)

C format (UNIX): void RSDLLSwapBytes(void *pArray, const long size, const long count)

Parameters:

<code>pArray</code>	Array in which modifications are made
<code>size</code>	Size of a single element in <code>pArray</code>
<code>count</code>	Number of elements in <code>pArray</code>

Example: RSDLLSwapBytes(Buffer, sizeof(float), ibcntl/sizeof(float))

This function swaps the display of various elements from *Big Endian* to *Little Endian* and vice versa. It is expected that a coherent storage area of elements of the same file type (`size` byte) is transferred to `pArray`. This function has no effect on Intel platforms.

Different types of processor architecture store data in different byte sequences. For example, Intel processors store data in the reverse order of Motorola processors. Comparison of byte sequences:

Byte sequence	Use in	Display in memory	Description
Big Endian	Motorola processors, network standard	Most significant byte at least significant address	The <i>most significant</i> byte is at the left end of the word.
Little Endian	Intel processors	Least significant byte at least significant address	The <i>most significant</i> byte is at the right end of the word.

Example:

```

Dim ibsta As Integer      ' Status variable
Dim iberr As Integer     ' Error variable
Dim ibcntl As Long       ' Count variable
Dim ud As Integer        ' Handle for measuring instrument
Dim Result As String     ' Buffer for simple results
Dim Digits As Byte       ' Number of digits of length indication
Dim TraceBytes As Long   ' Length of trace data in bytes
Dim TraceData(501) As Single ' Buffer for floating point
                          ' Binary data

' Set up connection to instrument
ud = RSDLLibfind("89.10.38.97", ibsta, iberr, ibcntl)

' Query trace data in real format
Call RSDLLibwrt(ud, "FORM:DATA REAL,32", ibsta, iberr, ibcntl)
Call RSDLLibwrt(ud, "TRACE? TRACE1", ibsta, iberr, ibcntl)

'Read number of digits of length indication
Result = Space$(20)
Call RSDLLilrd(ud, Result, 2, ibsta, iberr, ibcntl)
Digits = Val(Mid$(Result, 2, 1))

'Read length indication
Result = Space$(20)
Call RSDLLilrd(ud, Result, Digits, ibsta, iberr, ibcntl)
TraceBytes = Val(Left$(Result, Digits)) 'and store

' Read out trace data
Call RSDLLilrdTraceReal(ud, TraceData(0), TraceBytes, ibsta, iberr, ibcntl)

```

Programming examples:

- In this example, the start frequency of the instrument is queried.

```

Dim ibsta As Integer      ' Status variable
Dim iberr As Integer     ' Error variable
Dim ibcntl As Long       ' Count variable
Dim ud As Integer        ' Handle for measuring instrument
Dim Response As String   ' Response string

' Set up connection to measuring instrument
ud = RSDLLibfind("89.10.38.97", ibsta, iberr, ibcntl)
If (ud < 0) Then
    ' Error treatment
End If

' Send query command
Call RSDLLibwrt(ud, "FREQ:START?", ibsta, iberr, ibcntl)

' Provide space for response
Response = Space$(100)

' Read response from measuring instrument
Call RSDLLibrd(ud, Response, ibsta, iberr, ibcntl)

```

- In this example, a Save/Recall of the instrument setups is performed.

```
Dim ibsta As Integer      ' Status variable
Dim iberr As Integer      ' Error variable
Dim ibcntl As Long        ' Count variable
Dim ud As Integer         ' Handle for measuring instrument
Dim Cmd As String         ' Command string

' Set up connection to measuring instrument
ud = RSDLLibfind("89.10.38.97", ibsta, iberr, ibcntl)
If (ud < 0) Then
    ' Error treatment
End If

' Request instrument settings
Cmd = "SYST:SET?"
Call RSDLLibwrt(ud, Cmd, ibsta, iberr, ibcntl)

' Store instrument response in file
Call RSDLLibrdf(ud, "C:\db.sav", ibsta, iberr, ibcntl)

' Reset instrument
Call RSDLLibwrt(ud, "*RST", ibsta, iberr, ibcntl)

' and restore the previous settings
' to this end disable the END message
Call RSDLLibeot(ud, 0, ibsta, iberr, ibcntl)
' first send off command
Call RSDLLibwrt(ud, "SYST:SET ", ibsta, iberr, ibcntl)
' enable the END message again
Call RSDLLibeot(ud, 1, ibsta, iberr, ibcntl)
' and send the data
Call RSDLLibwrtf(ud, "C:\db.sav", ibsta, iberr, ibcntl)
```

Visual Basic for Applications (Winword and Excel)

Programming tips:

The programming language Visual Basic for Applications (VBA) is supported as a macro language by various manufacturers. The programs Winword and Excel use this language for the versions Winword 97 or Excel 5.0 and higher.

For macros created with Visual Basic for Applications, the same tips are valid as for Visual Basic Applications.

Programming example:

- Using the macro `QueryMaxPeak`, a single sweep with subsequent query of the maximum peak is performed. The result is entered in a Winword or Excel document.

```
Sub QueryMaxPeak()

    Dim ibsta As Integer      ' Status variable
    Dim iberr As Integer     ' Error variable
    Dim ibcntl As Long      ' transferred characters
    Dim ud As Integer       ' Unit Descriptor (handle)for instrument
    Dim Response As String  ' Response string

    ' Set up connection to measuring instrument
    ud = RSDLLibfind("89.10.38.97", ibsta, iberr, ibcntl)
    If (ud < 0) Then
        Call MsgBox("Device with address 89.10.38.97 could" & _
            "not be found", vbExclamation)
    End
End If

    ' Determine maximum peak in the range 1-2MHZ
    Call RSDLLibwrt(ud, "*RST", ibsta, iberr, ibcntl)
    Call RSDLLibwrt(ud, "INIT:CONT OFF", ibsta, iberr, ibcntl)
    Call RSDLLibwrt(ud, "FREQ:START 1MHZ", ibsta, iberr, ibcntl)
    Call RSDLLibwrt(ud, "FREQ:STOP 2MHZ", ibsta, iberr, ibcntl)
    Call RSDLLibwrt(ud, "INIT:IMM;*WAI", ibsta, iberr, ibcntl)
    Call RSDLLibwrt(ud, "CALC:MARK:MAX;Y?", ibsta, iberr, ibcntl)
    Response = Space$(100)
    Call RSDLLibrd(ud, Response, ibsta, iberr, ibcntl)
    Response = RTrim(Response) ' Cut off space

    ' Insert value in current document (Winword)
    Selection.InsertBefore (Response)
    Selection.Collapse (wdCollapseEnd)

    ' Terminate connection to measuring instrument
    Call RSDLLibonl(ud, 0, ibsta, iberr, ibcntl)

End Sub
```

The entry of the peak value in the Winword document can be replaced as follows for Excel:

```
' Insert value in current document (Excel)
ActiveCell.FormulaR1C1 = Response
```

C / C++

Programming tips:

- Access to the functions of the RSIB32.DLL (Windows platforms)

The functions of the `RSIB32.DLL` are declared in the header file `RSIB.H`. The DLL functions can be linked to a C/C++ program in different ways.

1. Enter one of the supplied import libraries (`RSIB.LIB` or `RSIB32.LIB`) into the linker options.
2. Load the library using the function `LoadLibrary()` during runtime and determine the function pointers of the DLL functions using `GetProcAddress()`. Before the end of the program, the `RSIB.DLL` must be unloaded again using the function `FreeLibrary()`.

When import libraries are used, the DLL is automatically loaded immediately before the application is started. At the end of the program, the DLL is unloaded again unless it is still used by other applications.

- Access to `libsib.so` functions (UNIX platforms)

The functions of `libsib.so` are declared in the header file `RSIB.H`. Uppercase/lowercase characters for file names are typically observed under UNIX. The library functions are linked to a C/C++ program by entering the `-libsib` linker option.

The *shared library* `libsib.so` is automatically loaded on starting the application. The accessibility (for example via standard path) of the library must be ensured. Refer to the beginning of this main chapter under "UNIX Environment".

- Query of strings

If instrument responses are to be further processed as strings, a zero termination must be appended.

Example:

```
char buffer[100];
...
RSDLLibrd( ud, buffer, &ibsta, &iberr, &ibcntl );
buffer[ibcntl] = 0;
```

Programming example:

In the following C program example, a single sweep is started on the device with the IP address 89.10.38.97 and subsequently a marker is set to maximum level. Prior to the search for maximum, a synchronization to the end of the sweep is performed. For this purpose the command "*OPC" (Operation complete) is used to create a service request at the end of the sweep, for which the control program waits with the function RSDLLWaitSrq(). Then the maximum is determined ("CALC:MARK:MAX") and the level read out ("Y?").

```
#define MAX_RESP_LEN 100

short          ibsta, iberr;
unsigned long  ibcntl;
short         ud;
short         srq;
char          MaxPegel[MAX_RESP_LEN];
char          spr;

// Determine handle for instrument
ud = RSDLLibfind( "89.10.38.97", &ibsta, &iberr, &ibcntl );

// if instrument exists
if ( ud >= 0 )
{
    // Set timeout for RSDLLWaitSrq() to 10 seconds
    RSDLLibtmo( ud, 10, &ibsta, &iberr, &ibcntl );

    // Activate SRQ generation via event status register (ESR)
    // and enable ESB bit in SRE register
    RSDLLibwrt( ud, "*ESE 1;*SRE 32", &ibsta, &iberr, &ibcntl );

    // Set single sweep, trigger sweep and use "*OPC" to cause
    // the generation of a service request at the end of the sweep
    RSDLLibwrt( ud, "INIT:CONT off;INIT;*OPC", &ibsta, &iberr, &ibcntl );

    // Wait for SRQ (end of sweep)
    RSDLLWaitSrq( ud, &srq, &ibsta, &iberr, &ibcntl );

    // Clear RQS/MSS bit
    RSDLLibrsp( ud, &spr, &ibsta, &iberr, &ibcntl );

    // if sweep is terminated
    if (srq)
    {
        // then set marker to first maximum and query the level
        RSDLLibwrt( ud, "CALC:MARK:MAX;Y?", &ibsta, &iberr, &ibcntl );
        RSDLLilrd( ud, MaxPegel, MAX_RESP_LEN, &ibsta, &iberr, &ibcntl );
        MaxPegel[ibcntl] = 0;
    }
    // End connection to instrument
    RSDLLibonl( ud, 0, &ibsta, &iberr, &ibcntl );
}
else
{
    ; // Error Instrument not found
}
}
```

Trigger Port Option – R&S FSP-B28

Description

An essential performance criterion to be met by automatic test systems is to minimize the time overhead of the entire test relative to the net measurement time. A typical test comprises the following steps:

1. Setting of spectrum analyzer (frequency, level, bandwidth, measurement time, trigger source)
2. Setting of device under test (DUT) and activation of its output signal
3. Start of measurement on analyzer; analyzer waits for trigger signal
4. Generation of trigger signal; test system waits for ready signal from analyzer
5. Reading of measured data

After the start of a measurement, hardware settling times are allowed for the R&S FSP before data acquisition is started. Trigger signals received by the R&S FSP during the settling time will, therefore, be ignored.

This behaviour is not critical in most cases, as long as the trigger signal is periodic and the test signal is stationary.

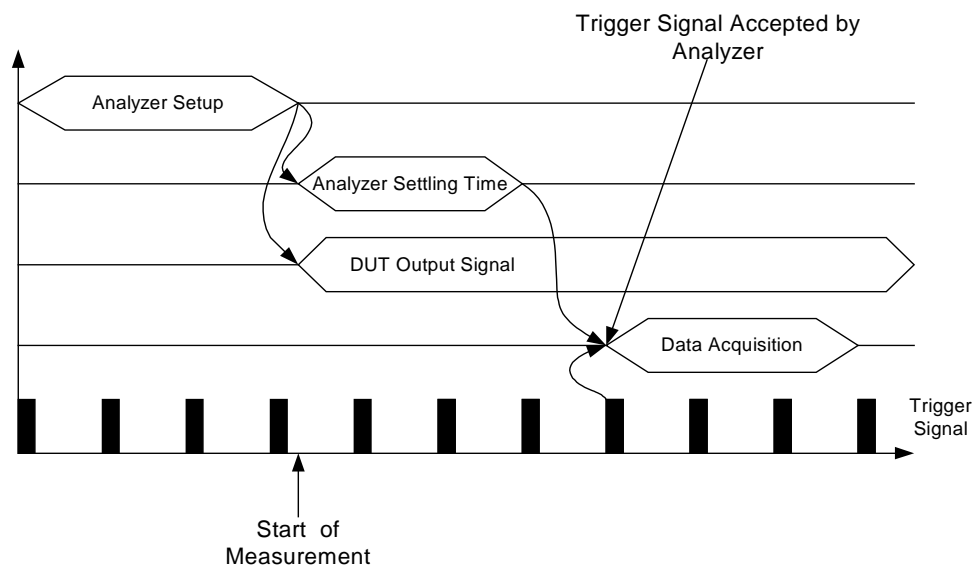

Fig. 4.24-1 Test with stationary test signal and periodic trigger signal

In the above case, the analyzer will respond to the first trigger signal received after the settling time.

The situation is quite different, however, if data acquisition is to be started by a single trigger event. In such a case it is mandatory that settling times on the analyzer have elapsed before the trigger signal is sent. Otherwise, the trigger signal will not be identified as a request for data acquisition, and the subsequent query of measured data will result in a timeout on the controller:

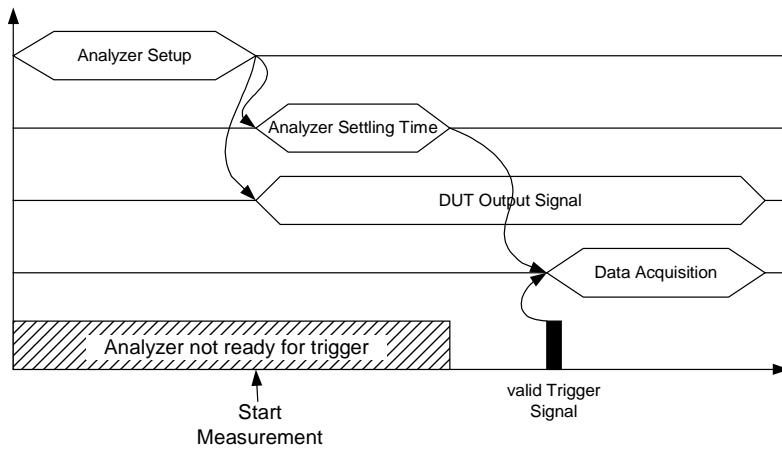

Fig. 4.24-2 Test with single trigger pulse

A particularly difficult aspect of this problem is the variable settling times of the analyzer, which are unavoidable in practice. If there is no signal to indicate that the analyzer is ready to collect measured data, the maximum settling time will have to be allowed for until the trigger signal is sent, thus ensuring reliable measurements. This results in considerable – and in many cases unacceptable – time overhead, depending on the instrument settings.

To minimize this overhead, the optional Trigger Port R&S FSP-B28 supplies a signal that indicates the analyzer's readiness to collect measured data. The signal is reset on detection of the next trigger signal. In this way, a handshake is established between the analyzer and the DUT and between the analyzer and the controller, which ensures reliable measurements and reduces the time overhead to the settling time actually needed by the analyzer:

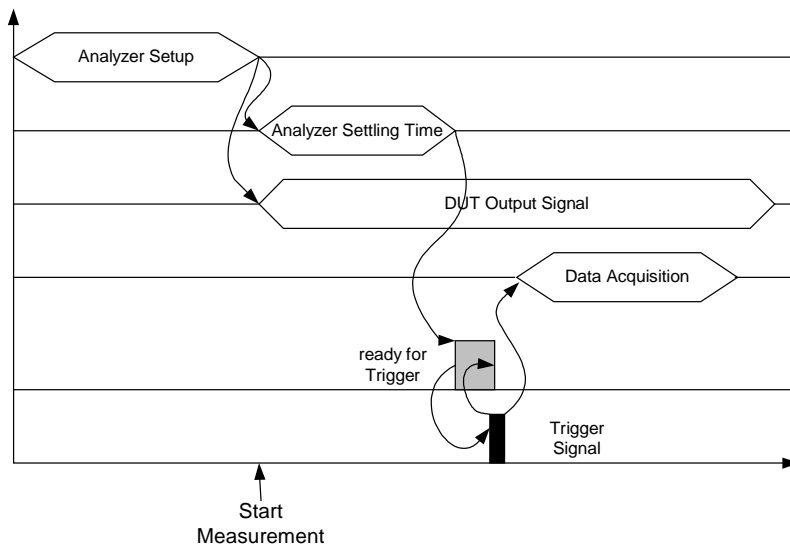

Fig. 4.24-3 Test with ready-for-trigger signal

Mechanical Design

The Trigger Port is implemented as a 25-contact Cannon female connector on the analyzer rear panel.

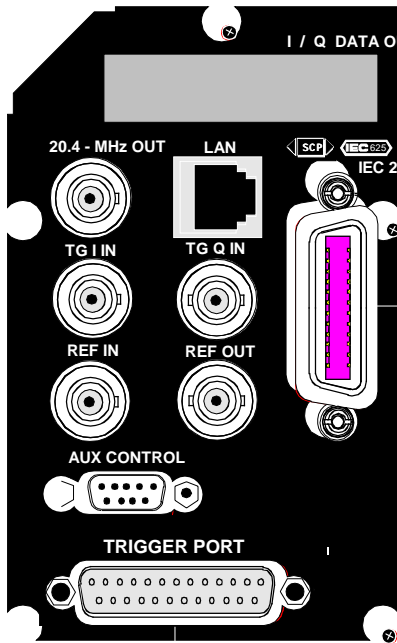

Fig. 4.24-4 Detail of analyzer rear panel

Fig. 4.24-5 shows the pin assignment of the Trigger Port output:

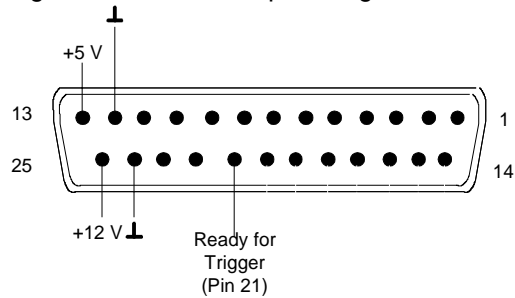

Fig. 4.24-5 Pin assignment of Trigger Port

Electrical Characteristics

Pins 13 and 25 of the Trigger Port are allocated supply voltages for low-power circuits.

Pins 12 and 24 are taken to ground.

The ready-for-trigger signal is assigned to pin 21.

Note: Pins 14 through 20 are reserved and must not be connected to live conductors or to ground.

Assignment and data of Trigger Port pins:

Pin	Signal	Range of values
1 through 11	Not used	
12	GND	
13	+5 V supply voltage	5.2 V \pm 0.5 V, max. 30 mA
14 through 20	Reserved	
21	Ready-for-trigger output signal	HIGH: \geq 1.4 V LOW: \leq 0.7 V
22 through 23	Not used	
24	GND	
25	+12 V supply voltage	+12 V \pm 0.5 V, max. 10 mA

10 Index

Note: All softkeys are listed alphabetically under keyword "Softkey" with their names. The page numbers 4.xxx refer to the detailed description of the softkeys in chapter 4. Generally, the number of the page in chapter 6 containing the equivalent remote control command is given in addition.

A list of softkeys and equivalent remote control commands or command sequences is given in chapter 6, section "Table of Softkeys with IEC/IEEE-Bus Command Assignment". Chapter 6 also contains an alphabetical list of all remote control commands.

- *
 - * (enhancement label)..... 3.6
 - * (enhancement label)..... 4.10-4

- 0**
 - 0 to 9 (key) 3.11

- 1**
 - 1 - 2 (trace info) 4.10-14
 - 1 - 3 (trace info) 4.10-14

- 2**
 - 20.4 MHz Out 8.12

- 7**
 - 75 Ω (enhancement lable) 3.6

- A**
 - Abort
 - recording of correction data 4.11-2
 - AC supply connection 1.16
 - ACP measurement 4.15-7
 - Addressed command 8.5
 - Adjacent-channel power
 - number of channels 4.15-14
 - Administrator function 1.19
 - AF demodulation 4.13-9
 - AF OUTPUT 8.2
 - AM demodulation 4.13-10
 - AM modulation 4.21-17
 - AM modulation depth 4.15-34
 - Amplitude 4.6-1
 - Amplitude probability distribution function 4.15-28
 - Amplitude statistics 4.15-26
 - Analyzer mode 4.4.1
 - Annotation 4.17-4
 - AP (trace info) 3.5
 - APD function 4.15-28
 - Ascii # 5.14
 - Attenuation 4.6-3
 - Autopeak detector 4.10-11
 - AUX CONTROL
 - interface 8.12

- AUX CONTROL connector** 8.12
- AV (trace info)** 3.5
- Average detector** 4.10-10, 4.10-13
- Averaging** 4.10-3, 4.15-5
 - continuous sweep 4.10-3
 - lin/log 4.10-5
 - single sweep 4.10-3
 - sweep count 4.10-3
- AVG (trace info)** 3.5

- B**
 - BACK (key) 3.11
 - Band filter, digital 4.7-7
 - Bandpass 4.7-7
 - Bandwidth
 - occupied 4.15-23
 - resolution 4.7-3
 - video 4.7-3
 - Base spreading factor 6.1-254
 - Baud rate 4.18-12
 - Befehl
 - Zuordnung Softkey 6.4-1
 - Block data 5.14
 - Boolean parameter 5.13
 - Brightness 4.17-6
 - Brightness, Screen 4.20-8

- C**
 - Calibration
 - functioning 4.21-13, 4.22-10
 - reflection measurement 4.22-9
 - reflexion measurement 4.21-12
 - transmission measurement 4.21-5, 4.22-3
 - Calibration results 4.11-3
 - CANCEL (key) 3.11
 - CCDF function 4.15-28
 - CCIR 473-4 4.9-9
 - CCVS signal 4.9-10
 - Center frequency 4.4-2
 - Step size 4.4-2
 - Channel
 - power 4.15-17
 - bandwidth 4.15-15, 4.15-23, 4.15-33
 - number 4.15-14
 - spacing 4.15-16
 - Channel filters 4.7-9
 - Channel power measurement 4.15-9
 - Characters, special 6.1-2
 - Clear/Write mode 4.10-2
 - CLWR (trace info) 3.5
 - CODE DOM OVERVIEW 6.1-258

- Colon 5.14
 - Color 4.17-6, 4.20-6
 - Color printout 4.20-6
 - COM interface 4.18-12, 8.7
 - Comma 5.14
 - Command
 - # 5.14
 - addressed 8.5
 - colon 5.14
 - comma 5.14
 - description 6.1-1
 - header 5.10
 - line 5.12
 - long form 5.11
 - overlapping execution 5.17
 - programming examples 7.1
 - query 5.12
 - question mark 5.12, 5.14
 - quotation mark 5.14
 - recognition 5.16
 - sequence 5.17
 - short form 5.11
 - structure 5.9
 - suffix 5.11
 - syntax elements 5.14
 - universal 8.5
 - white space 5.14
 - Common commands 6.1-4
 - CONDition register part 5.19
 - Configuration 4.18-1
 - save 4.19-1
 - Continue single sweep 4.8-2
 - Continuous sweep 4.8-1
 - Control
 - output level 4.21-3
 - Control characters 8.9
 - Copy
 - file 4.19-15
 - limit line 4.16-5
 - trace 4.10-8
 - Correction
 - inherent noise 4.15-11
 - Correction data 4.11-1
 - Correction of entry 3.17
 - Correction values
 - normalization 4.21-1, 4.22-1
 - Counter resolution 4.12-4
 - Coupling
 - bandwidths 4.7-1
 - default settings 4.7-5, 4.7-7
 - frequency of diagrams 4.17-3
 - reference level of diagrams 4.17-3
 - resolution bandwidth 4.7-4
 - sweep time 4.7-5
 - video bandwidth 4.7-4
 - Create directory 4.19-14
 - Cumulative distribution function 4.15-28
- D**
- Date 4.17-4
 - input 4.18-15
 - DCL 5.16
 - Decimal point 3.11
 - Default
 - coupling ratios 4.7-5
 - display settings 4.17-4
 - scalings of x- and y-axis 4.15-30
 - Delay, gate signal 4.9-6
 - Delete
 - file 4.19-15
 - limit line 4.16-5
 - Demodulation 4.13-9
 - Detector
 - autopeak 4.10-9
 - average 4.10-10
 - max peak 4.10-9
 - min peak 4.10-9
 - quasipeak 4.10-10
 - RMS 4.10-10
 - sample 4.10-9
 - Device reset (overall) 4.2
 - Diskette, format 4.19-17
 - Display
 - brightness 4.17-6
 - color 4.17-6
 - date 4.17-4
 - deactivation during single sweep 4.8-3
 - power-save mode 1.18, 4.17-5
 - saturation 4.17-6
 - time 4.17-4
 - tint 4.17-6
 - title 4.17-4
 - Display line 4.16-11
 - Display mode
 - full screen 3.8, 4.17-2
 - split screen 3.8, 4.17-2
 - Display range
 - frequency 4.4-2
 - level 4.6-1
 - span 4.5-1
 - Distribution function 4.15-28
 - Double dagger 5.14
- E**
- Editing
 - limit line 4.16-6
 - parameter 3.16
 - table 3.23
 - Electrostatic discharge 1.14
 - ENABle register part 5.19
 - Enabling the front panel keys 4.3-1
 - Enhancement labels 3.6
 - ENTER (key) 3.11
 - Entry
 - abort 3.11
 - activate 3.14, 3.25
 - correct 3.17
 - terminate 3.11
 - Error messages 4.18-23, 9.1
 - Error variable - iberr 4.23-38
 - Error-queue query 5.32
 - ESC (key) 3.11
 - ESE (event status enable register) 5.22
 - ESR (event status register) 5.22
 - EVENT register part 5.19
 - Event status enable register (ESE) 5.22
 - Event status register (ESR) 5.22
 - EXT (enhancement lable) 3.6
 - EXT TRIGGER/GATE input 4.9-2, 8.11
 - External generator 4.22-1
 - External noise source 4.18-2

F

Fast power measurement.....	4.15-12
FFT filter.....	4.7-7
Field, first or second.....	4.9-9
File	
copy.....	4.19-15
delete.....	4.19-15
rename.....	4.19-15
sort.....	4.19-16
Filter	
band filter.....	4.7-7
FFT.....	4.7-7
Firmware update.....	4.18-27
Firmware version.....	4.18-22
Fixed filter.....	4.7-7
FM demodulation.....	4.13-10
FM modulation.....	4.21-17
Free-run sweep.....	4.9-1
Frequency.....	4.4.1
axis labelling.....	3.4
center.....	4.4-2
counter.....	4.12-4
coupling of diagrams.....	4.17-3
display window.....	4.4.1, 4.5-1
Line.....	4.16-12
offset.....	4.4-5
Offset (ext. generator).....	4.22-11
offset (tracking generator).....	4.21-14
span.....	4.5-1
start.....	4.4-4
stop.....	4.4-4
switching off display.....	4.17-4
Frequency-converting measurements.....	4.21-14, 4.22-11
FRQ (enhancement table).....	3.6
FS-K5.....	6.1-112
FS-K72/K73.....	6.1-250
Full screen.....	3.8, 4.17-2
Full span.....	4.5-1

G

GAT (enhancement table).....	3.6
Gate	
delay.....	4.9-6
external/internal.....	4.9-4
length.....	4.9-6
GET (Group Execute Trigger).....	5.16
Getting Started with the Instrument.....	1.14
GHz-dBm (key).....	3.11
GSM MS Analyzer (FS-K5).....	6.1-112

H

Hardcopy	
screen.....	4.20-2
Hardware Adjustment.....	4.18-27
Hardware settings, indication.....	3.3
Header.....	5.10
Help line editor.....	3.20
Horizontal sync signal.....	4.9-9
Hotkey	
NETWORK.....	4.21-1
SCREEN A/B.....	4.2-1, 6.1-152
SPECTRUM.....	4.2-1, 4.4.1, 6.1-188
Hue, Screen.....	4.20-8
Hz/dB. (key).....	3.11

I

I/Q modulation.....	4.21-18
IEC Bus	
Interface.....	8.12
IEC/IEEE bus	
address.....	4.18-10
command description.....	6.1-1
interface.....	8.3
interface functions.....	8.4
programming examples.....	7.1
I FOVL.....	3.5
Impedance of input.....	4.6-4
Indication	
hardware settings.....	3.3
instrument settings.....	3.6
marker information.....	3.4
Inherent noise, Correction.....	4.15-11
Initial configuration.....	4.2
Input	
EXT TRIGGER/GATE.....	4.9-2, 8.11
REF IN.....	8.11
Input impedance.....	4.6-4
Instrument functions.....	4.1
Interface functions	
IEC/IEEE bus.....	8.4
Interfaces.....	8.2
Intermodulation product.....	4.15-35
Interrupt.....	5.31
IST flag.....	5.22

K

Key	
0 to 9.....	3.11
AMPT.....	4.6-1
BACK.....	3.11
BW.....	4.7-2
CAL.....	4.11-1
CANCEL.....	3.11
DISP.....	4.17-1
ENTER.....	3.11
ESC.....	3.11, 6.1-33
FILE.....	4.19-1
FREQ.....	4.4.1
GHz-dBm.....	3.11
Hz/dB.....	3.11
kHz/dB.....	3.11
LINES.....	4.16-2, 4.16-11
MEAS.....	4.15-1
MHz/dBm.....	3.11
MKR.....	4.12-1
MKR FCTN.....	4.13-1
MKR to.....	4.14-1
PRESET.....	4.2, 6.1-7, 6.1-322
SETUP.....	4.18-1
SPAN.....	4.5-1
spinwheel.....	3.12
SWEEP.....	4.8-1
TRACE.....	4.10-1
TRIG.....	4.9-1
keyboard	
connect.....	1.20
Keyboard	
connector.....	8.2
kHz/dB (key).....	3.11

L

LAN	
Interface	8.12
LAN Interface	4.23-1
LAN-Interface	4.23-1
Level	4.6-1
display range	4.6-1
offset (phase noise)	4.13-5
offset (tracking generator)	4.21-3
range	4.6-1
reference	4.6-1
Limit	
ACP measurement	4.15-19
evaluation range	4.15-4
probability range	4.15-30
Limit check	4.16-4
ACP measurement	4.15-19
Limit Check	4.16-4
Limit line	
copy	4.16-5
delete	4.16-5
domain	4.16-7
edit	4.16-6
limit check	4.16-4
offset	4.16-5
save	4.16-10
scaling	4.16-8
select	4.16-3
shift	4.16-10
unit	4.16-8
value	4.16-10
Line	
Frequency (Frequency Line 1, 2)	4.16-12
limit	4.16-3
reference (tracking generator)	4.21-8, 4.22-6
threshold	4.14-3
Time (Time Line 1, 2)	4.16-12
Line system	4.9-10
Lines	4.16-12
LO exclude	4.14-7
Login/out (NT controller)	1.19
Logo	4.17-4
Lower case	6.1-2
LPT interface	8.6

M

Maintenance	8.1
Manual operation	
return to	5.4, 5.6
switch to	4.3-1
Marker	4.12-1
center frequency to	4.14-2
CF stepsize to	4.14-4
indication	3.4
N dB Down	4.13-6
normal	4.12-1
peak	4.13-2, 4.14-1
reference level to	4.14-2
search limit	4.14-3
signal track	4.4-5
to trace	4.12-3, 4.13-10
zoom	4.12-7
Max hold	4.10-2
Max peak detector	4.10-12
MAXH (trace info)	3.5
Maximum peak value	4.15-5
Maximum search	4.14-1
Maximum value	4.15-3

Mean power (GSM burst)	4.15-4
Mean value	4.15-4
Measurement	
frequency-converting	4.21-14, 4.22-11
reflection	4.22-9
reflexion	4.21-11
transmission	4.21-4, 4.22-3
Measurement example	
ACP with user-specific channel configuration	4.15-21
adjacent-channel power for a specific standard	4.15-20
CCDF of a IS95 BTS signal	4.15-31
occupied bandwidth of a PDC signal	4.15-25
signal/noise power density (C/No) of an IS95 CDMA signal	4.15-22
Measurement Example	
Harmonic	2.5
Measurement of Carrier/Noise Ratio C/N and C/No	4.15-32
Measurement, save	4.19-1
Menu	
call	3.10
change keys	3.10
Messages	4.18-23
acknowledgement	3.7
MHz/dBm (key)	3.11
MI (trace info)	3.5
Min hold	4.10-5
Min peak detector	4.10-12
MINH (trace info)	3.5
Minimum search	4.14-5
Mobile radio standard	4.15-10
Mode	
analyzer	4.4.1
Modulation	
external (tracking generator)	4.21-16
Modulation depth	4.15-34
Monitor	
connection	1.22
connector	8.10
Mouse	8.11
connector	8.11
Mouse connection	8.11
Mouse connector	8.2

N

Network	4.21-1
Noise	
source, external	4.18-2
Noise measurement	4.13-2
NOISE SOURCE	8.10
Noise, Correction	4.15-11
Normalization	4.21-7, 4.22-5
NT computer	1.19
NTRansition register part	5.19
Numerical values (command)	5.13

O

Occupied bandwidth	4.15-23
Offset	
frequency	4.4-5
frequency (ext. generator)	4.22-11
gate signal	4.9-6
level (tracking generator)	4.21-3
limit line	4.16-5
phase noise	4.13-5
reference level	4.6-4
trigger	4.9-2
Operating mode	

analyzer..... 4.4.1
 Operating time 4.18-22
 option
 FSP-B16 - LAN Interface..... 4.23-1, 8.12
 Option
 FS-K72/K73..... 6.1-250
 FSP-B10 – External Generator 4.22-1
 FSP-B6 – TV and RF Trigger 4.9-8
 FSP-B9 – Tracking Generator 4.21-1
 Option:..... 6.1-112
 Order number 4.18-21
 Output
 AF OUTPUT..... 8.2
 IF 20.4 MHz Out 8.12
 noise source control 8.10
 REF OUT 8.11
 Output level
 control 4.21-3
 OVEN 3.5
 Overwrite mode 4.10-2
 OVL..... 3.5, 4.21-13, 4.22-10

P

Packing..... 8.1
 Parallel poll 5.32
 Parallel poll enable register (PPE) 5.22
 Parameter
 block data 5.14
 boolean 5.13
 editing 3.16
 numerical values 5.13
 selection 3.13
 string 5.14
 text 5.14
 Password
 service functions..... 4.18-25
 Windows NT..... 1.19
 Path..... 4.19-14
 Peak search 4.13-2, 4.14-1
 Phase noise measurement 4.13-4
 PK (trace info)..... 3.5
Plotter
 connection..... 4.20-3
 Polarity
 external trigger/gate..... 4.9-5
 trigger edge 4.9-2
 video 4.9-10
 Power bandwidth percentage 4.15-23
 Power cables 8.1
 Power measurement..... 4.15-1
 CP/ACP..... 4.15-7
 Fast 4.15-12
 occupied bandwidth..... 4.15-23
 signal amplitude statistics 4.15-26
 Time domain..... 4.15-2
 trace 4.15-19
 Power, mean 4.15-4
 Power-save mode
 display..... 1.18
 hard disk..... 1.18
 PPE (parallel poll enable register)..... 5.22
 Preamplifier 4.18-3
 Preparing the Instrument for Operation..... 1.14
 Preset instrument 4.2
 Pretrigger..... 4.9-2
 Print
 start..... 4.20-2
 PRINT SCREEN (Gate Signal) 4.9-6
 printer

connect 1.23
 Printer
 configuration 4.20-1
 connection 4.20-3, 8.6
 interface 8.6
 PRN (enhancement table) 3.6
 Probe Power connector..... 8.2
 PTRansition register part..... 5.19
 Putting into operation
 AC supply connection 1.16

Q

QP (trace info)..... 3.5
 Quasipeak detector 4.10-10
 Query 5.12, 5.32
 Question mark..... 5.12, 5.14
 Quotation mark..... 5.14

R

Rackmounting 1.15
 Recording the correction data 4.11-1
 Reference
 dataset (tracking generator) 4.21-13
 external 4.18-2
 fixed 4.12-5
 frequency 4.12-5
 level to marker level 4.14-2
 line (tracking generator) 4.21-8, 4.22-6
 position for normalization 4.22-6
 Reference level 4.6-1
 channel power..... 4.15-12
 coupling of diagrams 4.17-3
 offset..... 4.6-4
 position 4.6-4
 to marker level 4.14-2
 Reference point
 frequency 4.12-5
 frequency (phase noise)..... 4.13-6
 level 4.12-5
 offset..... 4.12-5
 level (phase noise)..... 4.13-5
 offset..... 4.13-5
 time 4.12-6
 x axis 4.12-6
 Reference value
 channel power..... 4.15-11
 time domain power 4.15-5
 Referenz
 Datensatz (Mitlaufgenerator)..... 4.22-10
 Reflection measurement..... 4.21-11, 4.22-9
 Remote control
 basics 5.1
 IEC/IEEE bus..... 5.4
 RS-232-C..... 5.5
 switch over..... 5.3
Remote Control
 RSIB..... 4.23-35
 Rename
 directory 4.19-15
 file 4.19-15
 Reset
 device 4.2
 status reporting system 5.33
 Resolution bandwidth 4.7-3
 Resolution counter 4.12-4
 RESULT SUMMARY (TRACE2)..... 6.1-333
 RF ATTEN MANUAL..... 4.6-5

- RF attenuation 4.6-3
 RM (trace info) 3.5
 RMS detector 4.10-10, 4.10-12
 RMS value 4.15-3
 RS-232-C
 configuration 4.18-12
 interface 8.7
 transmission parameters 8.8
- S**
- SA (trace info) 3.5
 Sample detector 4.10-12
 Sample number 4.15-29
 Saturation 4.17-6
 Saturation, Screen 4.20-8
 Save
 configuration 4.19-1
 limit line 4.16-10
 measurement 4.19-1
 Scalar reflection measurement 4.21-11, 4.22-9
 Scaling 4.6-2
 level axis 4.6-4
 limit line 4.16-8
 x- and y-axis (signal statistic) 4.15-29
 SCPI
 conformity information 6.1-1
 introduction 5.9
 version 5.1
 Screen 3.1
 brightness 4.20-8
 full screen 4.17-2
 hue 4.20-8
 saturation 4.20-8
 split screen 3.8, 4.17-2
 subdivision 3.2
 Search
 bandwidth 4.4-5
 minimum 4.14-5
 peak 4.13-2, 4.14-1
 PEAK EXCURSION 4.13-8, 4.14-5
 range 4.14-3
 Selftest 4.18-26
 Sensitivity
 APD measurement 4.15-30
 CCDF measurement 4.15-30
 Serial interface 8.7
 configuration 4.18-12
 Serial number 4.18-21
 Serial poll 5.31
 Service functions 4.18-24
 Service Pack 1.19
 Service request (SRQ) 5.21, 5.31
 Service request enable register (SRE) 5.21
 Setting Up the Instrument 1.14
 Settings, indication 3.6
 Setup 4.18-1
 general 4.18-10
 SGL (enhancement table) 3.6
 Sign (key) 3.11
 Signal amplitude statistics 4.15-26
 Signal count 4.12-4
 Signal tracking 4.4-5
 search bandwidth 4.4-5
 Single sweep 4.8-1
 Soft key
 ACLR 6.1-138
 BAND CLASS 6.1-144
 BASE SF 6.1-254
 CAPTURE LENGTH 6.1-257
 CCDF 6.1-138
 CHAN TABLE HEADER 6.1-142
 CHAN TABLE VALUES 6.1-141
 CODE CHAN AUTOSEARCH 6.1-140
 CODE CHAN PREDEFINED 6.1-140
 CODE DOM ANALYZER 6.1-138
 COPY CHAN CONF TABLE 6.1-143
 DEL CHAN CONF TABLE 6.1-143
 EDIT CHAN CONF TABLE 6.1-140
 MARKER -> PICH 6.1-97
 MARKER -> TDPICH 6.1-97
 NEW CHAN CONF TABLE 6.1-140
 OCCUPIED BANDWIDTH 6.1-138
 ORDER 6.1-257
 PN OFFSET 6.1-251
 POWER 6.1-138
 POWER REF TOT/PICH 6.1-256
 SELECT CHANNEL 6.1-252
 SELECT PCG 6.1-253
 SPECTRUM EM MASK 6.1-138
 TIME/PHASE ON / OFF 6.1-257
 Softkey
 % POWER BANDWIDTH 4.15-23, 6.1-287
 = CENTER 4.4-3, 4.4-4
 = MARKER 4.4-3, 4.4-4
 0.1 * RBW 4.4-3, 6.1-270, 6.1-271
 0.1 * SPAN 4.4-2, 6.1-270, 6.1-271
 0.5 * RBW 4.4-3, 6.1-270, 6.1-271
 0.5 * SPAN 4.4-2, 6.1-270, 6.1-271
 ABSOLUTE PEAK/MIN 6.1-23, 6.1-24
 ACP LIMIT CHECK 4.15-19, 6.1-38
 ACP REF SETTINGS 4.15-16
 ACP REF SETTINGS 6.1-286
 ADJ CHAN BANDWIDTH 4.15-15, 6.1-285
 ADJ CHAN SPACING 4.15-16, 6.1-284
 ADJUST REF LVL 4.15-12, 4.15-24, 6.1-287
 ADJUST SETTINGS 4.15-30, 4.15-33, 6.1-104, 6.1-287
 ADJUST SETTINGS (occupied bandwidth) 4.15-24
 ADJUST SETTINGS (power measurements) 4.15-18
 ALL MARKER OFF 4.12-7, 6.1-21, 6.1-56
 AM 4.13-10, 6.1-68, 6.1-349
 AMPERE 4.6-2, 6.1-109, 6.1-357
 ANALOG I/Q 6.1-185
 ANNOTATION ON/OFF 4.17-4, 6.1-150
 APD ON/OFF 4.15-28, 6.1-103, 6.1-106
 area 3.9
 ASCII FILE EXPORT 4.10-6, 4.19-17, 6.1-176, 6.1-198
 AUTO SELECT 4.10-11, 6.1-266
 AVERAGE 6.1-119
 AVERAGE 4.10-3, 6.1-156, 6.1-243
 AVERAGE ON/OFF 4.15-5, 6.1-86, 6.1-87, 6.1-89, 6.1-90, 6.1-91
 AVG MODE LOG/LIN 4.10-5, 6.1-102, 6.1-244
 BALANCED ON OFF 6.1-187
 BLANK 4.10-4, 6.1-156
 BRIGHTNESS 4.17-6, 4.20-8, 6.1-151, 6.1-178
 C/N 4.15-32, 4.15-33
 C/No 4.15-33
 CAL ABORT 4.11-2, 6.1-110
 CAL CORR ON/OFF 4.11-2, 6.1-111
 CAL GEN 128 MHZ 4.18-25, 6.1-145
 CAL GEN COMB 4.18-25, 6.1-146
 CAL REFL OPEN 4.21-12, 4.22-9, 6.1-260, 6.1-262
 CAL REFL SHORT 4.21-12, 4.22-9, 6.1-260, 6.1-262
 CAL RESULTS 4.11-3, 6.1-111
 CAL TOTAL 4.11-1, 6.1-110
 CAL TRANS 4.21-6, 4.22-4, 6.1-260
 CCDF ON/OFF 4.15-28, 6.1-103, 6.1-106
 CCVS INT / EXT 4.9-10, 6.1-294
 CENTER 4.4-2, 6.1-270
 CENTER = MKR FREQ 4.14-2, 6.1-72
 CENTER A = MARKER B 4.17-3, 6.1-189

- CENTER B = MARKER A..... 4.17-3, 6.1-189
 CF STEPSIZE..... 6.1-270
 CHAN POWER ACP..... 6.1-76
 CHAN PWR / HZ..... 4.15-17, 6.1-80
 CHAN PWR ACP..... 4.15-9
 CHANNEL BANDWIDTH..... 4.15-23, 4.15-33, 6.1-285
 CHANNEL SPACING..... 6.1-283
 CLEAR ALL MESSAGES..... 4.18-23, 6.1-319, 6.1-320
 CLEAR/WRITE..... 6.1-119
 CLEAR/WRITE..... 4.10-2, 6.1-156
 CNT RESOL..... 6.1-58
 CNT RESOL..... 4.12-4
 CODE DOM ANALYZER..... 6.1-139
 COLOR ON/ OFF..... 6.1-179
 COLOR ON/OFF..... 4.20-6
 COLORS..... 4.20-3, 4.20-6
 COM INTERFACE..... 4.18-12, 6.1-316
 COMMENT SCREEN A/B..... 6.1-181
 COMPRESSED MODE..... 6.1-255
 CONFIGURE NETWORK..... 4.18-16
 CONT DEMOD..... 4.13-10, 6.1-69
 CONT MEAS..... 4.15-31, 6.1-182, 6.1-183
 CONTINUE SGL SWEEP..... 4.8-2, 6.1-182, 6.1-183
 CONTINUOUS SWEEP 4.7-10, 4.8-1, 6.1-182, 6.1-183
 COPY..... 4.19-15, 4.19-16, 6.1-192
 COPY LIMIT LINE..... 4.16-5, 6.1-34
 COPY TRACE..... 4.10-8, 6.1-342
 COUPLING DEFAULT..... 4.7-7, 6.1-246, 6.1-290
 COUPLING RATIO..... 4.7-5, 6.1-246
 CP/ACP ABS/REL..... 4.15-17, 6.1-285
 CP/ACP CONFIG..... 4.15-14, 6.1-38, 6.1-284
 CP/ACP ON/OFF..... 4.15-9, 6.1-76, 6.1-77, 6.1-81
 CP/ACP STANDARD..... 4.15-10, 6.1-81
 DATA SET CLEAR..... 4.19-11, 6.1-198
 DATA SET CLEAR ALL..... 6.1-198
 DATA SET LIST..... 4.19-11
 DATAENTRY OPAQUE..... 4.17-4
 dBm..... 4.6-2, 6.1-109, 6.1-357
 dBmV..... 4.6-2, 6.1-109, 6.1-357
 dBpW..... 4.6-2, 6.1-109, 6.1-357
 dBµA..... 4.6-2, 6.1-109, 6.1-357
 dBµV..... 4.6-2, 6.1-109, 6.1-357
 DC LEVEL..... 6.1-148
 DECIM SEP..... 4.10-8, 4.19-17, 6.1-176
 DEFAULT COLORS..... 4.17-4, 6.1-151, 6.1-177
 DEFAULT CONFIG..... 4.19-10, 6.1-200
 DEFAULT SETTINGS..... 4.15-30, 6.1-105
 DELETE..... 4.18-5, 4.19-15, 6.1-194, 6.1-197, 6.1-264
 DELETE LIMIT LINE..... 4.16-5, 6.1-34
 DELETE LINE..... 4.18-9
 DELETE VALUE..... 4.16-10
 DETECTOR..... 4.10-11, 6.1-266
 DETECTOR AUTOPEAK..... 4.10-11, 6.1-266
 DETECTOR AVERAGE..... 4.10-13, 6.1-266
 DETECTOR MAX PEAK..... 4.10-12, 6.1-266
 DETECTOR MIN PEAK..... 4.10-12, 6.1-266
 DETECTOR QPK..... 4.10-13, 6.1-266
 DETECTOR RMS..... 4.10-12, 6.1-266
 DETECTOR SAMPLE..... 4.10-12, 6.1-266
 DISPLAY LINE 1..... 4.16-12
 DISPLAY PWR SAVE..... 4.17-5, 6.1-150
 EDIT..... 4.18-5, 4.18-6, 6.1-263
 EDIT ACP LIMITS4.15-19, 6.1-38, 6.1-39, 6.1-40, 6.1-41, 6.1-42, 6.1-43, 6.1-44, 6.1-45
 EDIT COMMENT..... 4.19-8, 6.1-200
 EDIT LIMIT LINE4.16-7, 6.1-33, 6.1-47, 6.1-48, 6.1-50, 6.1-51, 6.1-52, 6.1-53, 6.1-54
 EDIT PATH..... 4.19-8, 4.19-14, 6.1-192, 6.1-197
 ENABLE ALL ITEMS..... 4.19-10, 6.1-200
 ENTER PASSWORD..... 4.18-25, 6.1-322
 EXCLUDE LO..... 4.14-7, 6.1-59
 EXT AM..... 4.21-17
 EXT AMFSP..... 6.1-295
 EXT FM..... 4.21-17
 EXT FMFSP..... 6.1-296
 EXT I/Q..... 4.21-18
 EXT I/QFSP..... 6.1-295
 EXT SOURCE..... 4.22-12
 EXT SRC ON/OFF..... 4.22-12, 6.1-298
 EXTERN..... 4.9-2, 6.1-293, 6.1-349
 FAST ACP ON/OFF..... 4.15-12, 6.1-288
 FILE MANAGER..... 4.19-13, 6.1-192
 FILTER TYPE..... 4.7-7, 6.1-247
 FIRMWARE UPDATE..... 4.18-27, 6.1-320
 FM..... 4.13-10, 6.1-68, 6.1-349
 FORMAT DISK..... 4.19-17, 6.1-194
 FREE RUN..... 4.9-1, 6.1-349
 FREQUENCY LINE 1/2..... 4.16-12
 FREQUENCY OFFSET4.4-5, 4.21-15, 4.22-11, 6.1-272
 FREQUENCY OFFSETFSP..... 6.1-296
 FREQUENCY SWEEP..... 4.22-15, 6.1-299, 6.1-300
 FULL SCREEN..... 4.17-2, 6.1-150
 FULL SIZE DIAGRAM..... 4.15-12
 FULL SPAN..... 4.5-1, 6.1-271
 GATE DELAY..... 4.9-6, 6.1-292
 GATE LENGTH..... 4.9-6, 6.1-292
 GATE MODE LEVEL/EDGE..... 4.9-5, 6.1-292
 GATE SETTINGS..... 4.9-5, 6.1-291
 GATED TRIGGER..... 4.9-4, 6.1-291, 6.1-293
 GEN REF INT/EXT..... 4.22-16
 GENERAL SETUP..... 4.18-10
 GPIB..... 4.18-10
 GPIB ADDRESS..... 4.18-10, 6.1-313
 GPIB LANGUAGE..... 4.18-11
 GRID ABS/REL..... 4.6-4, 6.1-153
 GRID MIN LEVEL..... 6.1-155
 HARDCOPY ABORT..... 6.1-177
 HARDWARE INFO..... 4.18-21, 6.1-6, 6.1-147
 HOR SYNC..... 4.9-9, 6.1-352
 I/Q Input 50 1k..... 6.1-187
 ID STRING FACTORY..... 4.18-10
 ID STRING USER..... 4.18-10
 IF POWER..... 4.9-2, 6.1-293, 6.1-349, 6.1-351
 INPUT CAL..... 4.18-24, 4.18-25, 6.1-145, 6.1-146
 INPUT RF..... 4.18-24, 4.18-25, 6.1-145
 INSERT VALUE..... 4.16-10
 INSTALL OPTION..... 4.18-18
 ITEMS TO SAVE/RECALL..... 4.19-9, 6.1-198
 LAST SPAN..... 4.5-1
 LEFT LIMIT..... 4.13-8, 4.14-3, 6.1-56, 6.1-57
 LIMIT ON/OFF..... 4.15-4, 6.1-56
 LINES 625 / 525..... 4.9-10, 6.1-352
 LOCAL..... 4.3-1, 5.6
 LOGO ON/OFF..... 4.17-4, 6.1-150
 MAIN PLL BANDWIDTH..... 4.7-9
 MAKE DIRECTORY..... 4.19-14, 6.1-196
 MANUAL..... 4.4-3
 MARKER 1 to 44.12-2, 6.1-22, 6.1-23, 6.1-55, 6.1-56, 6.1-59
 MARKER DEMOD..... 4.13-9, 6.1-68
 MARKER NORM/DELTA..... 4.12-2, 6.1-20
 MARKER ZOOM..... 4.12-7, 6.1-67
 MAX HOLD..... 6.1-119
 MAX HOLD..... 4.10-2, 6.1-156
 MAX HOLD ON/OFF4.15-5, 6.1-86, 6.1-88, 6.1-89, 6.1-91
 MEAN..... 4.15-4, 6.1-88
 MIN..... 4.14-5, 6.1-24, 6.1-61
 MIN HOLD..... 6.1-119
 MIN HOLD..... 4.10-5, 6.1-156
 MIXER LOW NOISE..... 4.6-3
 MKR -> CF STEPSIZE..... 4.14-4, 6.1-72
 MKR -> TRACE .4.12-3, 4.13-10, 4.14-4, 6.1-21, 6.1-56
 MKR DEMOD ON/OFF..... 4.13-9, 6.1-69

- MKR STOP TIME..... 4.13-10, 6.1-69
 MODULATION 4.21-16
 MODULATION DEPTH 4.15-34, 6.1-70
 MODULATION OFF 4.21-18
 MODULATION OFFFSP 6.1-295, 6.1-296
 MULT CARR ACP 4.15-9
 N dB DOWN..... 4.13-6, 6.1-65, 6.1-66, 6.1-67
 NAME4.16-7, 6.1-33, 6.1-34, 6.1-47, 6.1-48, 6.1-51, 6.1-53
 NETWORK..... 4.22-1
 NETWORK..... 4.22-2
 NETWORK LOGIN..... 4.18-17
 NEW..... 4.18-5, 4.18-6
 NEW LIMIT LINE4.16-7, 6.1-33, 6.1-34, 6.1-47, 6.1-48, 6.1-50, 6.1-52
 NEXT MIN..... 4.14-5, 6.1-24, 6.1-61, 6.1-62
 NEXT MIN LEFT 4.14-5
 NEXT MIN RIGHT 4.14-5
 NEXT PEAK..... 4.14-2, 6.1-23, 6.1-24, 6.1-25, 6.1-60
 NEXT PEAK LEFT 4.14-3
 NEXT PEAK RIGHT 4.14-2
 NO OF SAMPLES 4.15-29, 6.1-104
 NO. OF ADJ CHAN 4.15-14, 6.1-284
 NO. OF TX CHAN 4.15-14, 6.1-284
 NOISE CORR ON/OFF 4.15-11, 6.1-288
 NOISE MEAS 4.13-2, 6.1-68
 NOISE SRC ON/OFF 4.18-2, 6.1-146
 NORMALIZE 4.21-7, 4.22-5, 6.1-260
 NUMBER OF SWEEPS..... 6.1-118
 NUMBER OF SWEEPS..... 4.15-6, 6.1-291
 OCCUP BW ON/OFF 4.15-23, 6.1-76, 6.1-77, 6.1-81
 OCCUPIED BANDWIDTH..... 4.15-23, 6.1-76
 OPTIMIZED COLORS..... 4.20-7
 OPTIONS..... 4.18-18
 PEAK 4.13-2, 4.14-1, 4.15-3, 6.1-23, 6.1-60, 6.1-85
 PEAK EXCURSION 4.13-8, 4.14-5, 6.1-62
 PEAK LIST..... 4.13-7, 6.1-63
 PEAK LIST OFF..... 4.13-8, 6.1-63
 PEAK SEARCH..... 4.13-6, 4.13-8
 PERCENT MARKER..... 4.15-28, 6.1-59
 PH NOISE ON/OFF..... 4.13-5, 6.1-27
 PHASE NOISE..... 4.13-4, 6.1-27
 POLARITY POS/NEG 4.9-2, 4.9-5, 6.1-292, 6.1-352
 POWER ABS/REL..... 4.15-5, 6.1-92
 POWER OFFSET..... 6.1-297
 POWER ON/OFF4.15-3, 6.1-85, 6.1-87, 6.1-88, 6.1-90, 6.1-92
 PREAMP..... 4.18-3, 6.1-186
 PREDEFINED COLORS4.17-6, 4.20-8, 6.1-152, 6.1-178
 PRINT SCREEN..... 4.9-6, 4.20-2, 6.1-180, 6.1-197
 PRINT TABLE..... 4.20-2, 6.1-180, 6.1-181, 6.1-197
 PRINT TRACE..... 4.20-2, 6.1-180, 6.1-181, 6.1-197
 PULSE FREQ..... 6.1-148
 PWR OFFSET..... 4.21-3, 4.22-2
 RANGE LIN % dB 6.1-155
 RANGE LINEAR..... 4.6-2, 6.1-155
 RANGE LINEAR % 4.6-2
 RANGE LINEAR dB 4.6-2
 RANGE LOG 100 dB..... 4.6-1, 6.1-155
 RANGE LOG MANUAL 4.6-2, 6.1-155
 RBW / VBW MANUAL 4.7-6, 6.1-248
 RBW / VBW NOISE [10]..... 4.7-6, 6.1-248
 RBW / VBW PULSE [1]..... 4.7-6, 6.1-248
 RBW / VBW SINE [1/3]..... 4.7-5, 6.1-248
 RECALL 4.19-7, 4.22-8, 6.1-195, 6.1-262
 REF FXD ON/OFF 4.12-5, 6.1-25
 REF LEVEL 4.6-1, 6.1-154
 REF LEVEL = MKR LVL..... 4.14-2, 6.1-72
 REF LEVEL COUPLED..... 4.17-3, 6.1-189
 REF LEVEL OFFSET..... 4.6-4, 6.1-154
 REF LEVEL POSITION..... 4.6-4, 6.1-155
 REF POINT FREQUENCY..... 4.12-5, 4.13-6, 6.1-27
 REF POINT LEVEL..... 4.12-5, 4.13-5, 6.1-26
 REF POINT LVL OFFSET 4.12-5, 4.13-5, 6.1-26
 REF POINT TIME 4.12-6, 6.1-27
 REF POINT x-LEVEL..... 4.12-6, 6.1-27
 REF VALUE..... 4.21-9, 4.22-7, 6.1-154
 REF VALUE POSITION..... 4.21-8, 4.22-6, 6.1-155
 REFERENCE FIXED 4.12-5, 6.1-25
 REFERENCE INT/EXT 4.18-2, 6.1-289
 REMOVE OPTION..... 4.18-18
 RENAME 4.19-15, 6.1-196
 RES BW 4.15-29, 6.1-116, 6.1-245
 RES BW AUTO..... 4.7-4, 6.1-246
 RES BW MANUAL..... 4.7-3, 6.1-116, 6.1-245
 RESTORE FIRMWARE 4.18-27
 RF ATTEN AUTO 4.6-3, 6.1-184
 RF ATTEN MANUAL..... 4.6-3, 4.6-5, 6.1-184
 RF INPUT 50 Ω / 75 Ω 4.6-4, 6.1-186
 RF INPUT AC/DC 4.6-2
 RF POWER 4.9-8, 6.1-349, 6.1-351
 RIGHT LIMIT 4.13-8, 4.14-3, 6.1-56, 6.1-57
 RMS..... 4.15-3, 6.1-87
 SATURATION..... 4.17-6, 4.20-8, 6.1-151, 6.1-178
 SAVE..... 4.19-6, 6.1-197
 SAVE LIMIT LINE 4.16-10
 SAVE TRD FACTOR 4.18-9
 SCALING 4.15-29, 6.1-104
 SCREEN COLORS..... 4.20-7
 SCREEN TITLE 4.17-4, 6.1-153
 SEARCH LIMIT OFF..... 4.14-4, 6.1-56
 SEARCH LIMITS 4.14-3, 6.1-56
 SEARCH NEXT LEFT..... 6.1-24, 6.1-25, 6.1-62
 SEARCH NEXT RIGHT ... 6.1-24, 6.1-25, 6.1-60, 6.1-62
 SELECT GENERATOR4.22-13, 6.1-313, 6.1-314, 6.1-315
 SELECT ITEMS 4.19-10, 6.1-198, 6.1-199
 SELECT LIMIT LINE4.16-3, 6.1-32, 6.1-33, 6.1-50, 6.1-53
 SELECT MARKER..... 4.13-2, 4.14-1, 4.15-37, 6.1-55
 SELECT OBJECT..... 4.17-5, 4.20-7
 SELECT TRACE 4.4-5, 4.10-2, 4.15-19, 6.1-83, 6.1-288
 SELFTEST..... 4.18-26, 6.1-7
 SELFTEST RESULTS 4.18-26, 6.1-147
 SERVICE 4.18-24, 6.1-145
 SET CP REFERENCE..... 4.15-11, 6.1-286
 SET REFERENCE 4.15-5, 6.1-92
 SET TO DEFAULT 4.20-8
 SGL SWEEP DISP OFF 4.8-3, 6.1-183
 SHIFT X LIMIT LINE..... 4.16-10, 6.1-48
 SHIFT Y LIMIT LINE..... 4.16-10, 6.1-54
 SIGNAL COUNT 4.12-4, 6.1-58
 SIGNAL STATISTIC 4.15-28
 SIGNAL TRACK..... 4.4-5, 6.1-82
 SINGLE MEAS 4.15-31, 6.1-182, 6.1-183
 SINGLE SWEEP..... 4.8-1, 6.1-182, 6.1-183
 SOFT FRONT PANEL 4.18-19
 SORT MODE 4.19-16
 SORT MODE FREQ/LEVEL 4.13-8
 SOURCE CAL..... 4.21-5, 4.22-3
 SOURCE ON/OFF 4.21-2
 SOURCE POWER..... 4.21-3, 4.22-2, 6.1-297, 6.1-300
 SPAN MANUAL 4.5-1, 6.1-271
 SPAN/RBW AUTO [50]..... 4.7-6, 6.1-246
 SPAN/RBW MANUAL 4.7-7, 6.1-246
 SPLIT SCREEN..... 4.17-2, 6.1-150
 STANDARD DEVIATION 4.15-4, 6.1-90
 START 4.4-4, 6.1-271
 START LIMIT..... 4.15-4, 4.15-5, 6.1-57
 STARTUP RECALL 4.19-12, 6.1-196
 STATISTICS 4.18-22, 6.1-5
 STEPSIZE MANUAL..... 4.4-4
 STOP 4.4-4, 6.1-272
 STOP LIMIT..... 4.15-4, 4.15-5, 6.1-57
 SWEEP COUNT 6.1-118
 SWEEP COUNT..... 4.8-2, 4.10-4, 6.1-291

- SWEEP POINTS 4.8-3, 6.1-293
 SWEEP TIME 6.1-118
 SWEPTIME AUTO 4.7-5, 4.8-2, 6.1-290
 SWEPTIME MANUAL 6.1-118
 SWEPTIME MANUAL 4.5-1, 4.7-4, 4.8-2, 6.1-290
 SYSTEM INFO 4.18-20
 SYSTEM MESSAGES 4.18-23, 6.1-319, 6.1-320
 T1-T2 4.10-14, 6.1-101
 T1-T3 4.10-14, 6.1-101
 THRESHOLD 4.13-8, 4.14-3, 6.1-107, 6.1-108
 TIME DOM POWER 4.15-2, 6.1-85, 6.1-87, 6.1-88, 6.1-90
 TIME LINE 1/2 4.16-12
 TIME+DATE 4.18-15, 6.1-319, 6.1-323
 TIME+DATE ON/OFF 4.17-4, 6.1-153
 TINT 4.17-6, 4.20-8, 6.1-151, 6.1-178
 TOI 4.15-36, 6.1-71
 TRACE MATH 4.10-14, 6.1-101
 TRACE MATH OFF 4.10-14, 6.1-102
 TRACE POSITION 4.10-14, 6.1-101
 TRACK BW 4.4-5, 6.1-82
 TRACK ON/OFF 4.4-5, 6.1-82
 TRACK THRESHOLD 4.4-5, 6.1-83
 TRACKING 4.21-2
 TRANSDUCER 4.18-4, 6.1-263
 TRANSDUCER FACTOR 4.18-4, 6.1-263, 6.1-264
 TRIGGER OFFSET 4.9-2, 6.1-352
 TV TRIG SETTINGS 4.9-9
 TV TRIGGER ON/OFF 4.9-9, 6.1-294
 UNIT 4.6-2, 6.1-109, 6.1-357
 USER DEFINED 4.20-7
 VALUES 4.16-10, 6.1-47, 6.1-49, 6.1-52
 VBW LIN LOG 4.7-10, 6.1-248
 VERT SYNC 4.9-9, 6.1-353
 VERT SYNC EVEN FIELD 4.9-9, 6.1-353
 VERT SYNC ODD FIELD 4.9-9, 6.1-353
 VIDEO 4.9-1, 6.1-349, 6.1-351
 VIDEO BW AUTO 4.7-4, 6.1-247
 VIDEO BW MANUAL 4.7-3, 6.1-247
 VIDEO POL POS / NEG 4.9-10, 6.1-353
 VIEW 6.1-119
 VIEW 4.10-4, 6.1-156
 VOLT 4.6-2, 6.1-109, 6.1-357
 WATT 4.6-2, 6.1-109, 6.1-357
 X * RBW 4.4-3, 6.1-270, 6.1-271
 X * SPAN 4.4-2, 6.1-270, 6.1-271
 X OFFSET 4.16-5, 6.1-48
 X-AXIS RANGE 4.15-30, 6.1-105
 X-AXIS REF LEVEL 4.15-29, 6.1-104
 Y OFFSET 4.16-5, 6.1-50, 6.1-53
 Y-AXIS MAX VALUE 4.15-30, 6.1-105
 Y-AXIS MIN VALUE 4.15-30, 6.1-105
 YIG CORR ON/OFF 4.11-2
 ZERO SPAN 4.5-1, 6.1-271
 ZOOM x-AXIS 4.9-6
 Zuordnung Befehl 6.4-1
- Softkey**
 ACLR 6.1-139
 CCDF 6.1-139
 CHAN TABLE VALUES 6.1-141
 DATA 6.1-258
 MAC 6.1-258
 MAPPING AUTO 6.1-253
 MAPPING COMPLEX 6.1-253
 MAPPING I OR Q 6.1-253
 OCCUPIED BANDWIDTH 6.1-139
 PILOT 6.1-258
 POWER 6.1-139
 PREAMBLE 6.1-258
 RESTORE STD TABLES 6.1-144
 SELECT CODE 6.1-253
 SPECTRUM EM MASK 6.1-139
 Softkey GRID MIN LEVEL 6.1-155
- Span 4.5-1
 Special characters 6.1-2
 Spectrum analyzer mode 4.4.1
 Spinwheel 3.12
 Split screen 3.8, 4.17-2
 Squelch 4.13-9
 SRE (service request enable register) 5.21
 SRQ (service request) 5.21, 5.31
 Standard deviation 4.15-4
 Standard, mobile radio 4.15-10
 Start frequency 4.4-4
 Statistics 4.15-26
 Status byte (STB) 5.21
 Status information 3.4
 IFOVL 3.5
 OVEN 3.5
 OVL 3.5
 UNCAL 3.4
 STATus OPERation register 5.23
 STATus QUEStionable register 5.24
 ACPLimit register 5.25
 FREQuency register 5.26
 LIMit register 5.27
 LMARgin register 5.28
 POWer register 5.29
 SYNC 5.30
 Status register
 CONDition part 5.19
 ENABLe part 5.19
 ESE 5.22
 ESR 5.22
 EVENT part 5.19
 NTRansition part 5.19
 overView 5.20
 PPE 5.22
 PTRansition part 5.19
 SRE 5.21
 STATus OPERation 5.23
 STATus QUEStionable ACPLimit 5.25
 STATus QUEStionable FREQuency 5.26
 STATus QUEStionable LIMit 5.27
 STATus QUEStionable LMARgin 5.28
 STATus QUEStionable POWer 5.29
 STATus QUEStionable SYNC 5.30
 STB 5.21
 structure 5.18
 sum bit 5.19
 Status reporting system 5.18
 resetting values 5.33
 STB (status byte) 5.21
 Stepsize 4.4-4
 center frequency 4.4-2
 coupling 4.4-4
 Stop frequency 4.4-4
 Store
 trace 4.19-17
 Storing 8.1
 String 5.14
 Suffix 5.11
 Sum bit 5.19
 Supply voltage, external noise source 4.18-2
 Sweep
 continue single sweep 4.8-2
 continuous 4.8-1
 count 4.8-2
 coupling 4.7-1
 free run 4.9-1
 gated 4.9-3, 4.9-4
 settings 4.8-1
 single 4.8-1
 time 4.5-1, 4.8-2
 coupling 4.7-5

Switching cycles	4.18-22
Switching on/off	1.16
SYMBOL EVM (TRACE2)	6.1-334, 6.1-341
Sync signal	4.9-9
Syntax elements of commands	5.14
System messages	4.18-23

T

T1-T2 (trace info)	3.5
T1-T3 (trace info)	3.5
Table	
operation	3.23
scrolling	3.25
Test	
functional	1.18
selftest	4.18-26
Text parameter	5.14
Third Order Intercept	4.15-35
Threshold	
line	4.14-3
signal tracking	4.4-5
Time	4.17-4
input	4.18-15
Line	4.16-12
Time axis	4.5-1
Tint	4.17-6
Title for the active diagram	4.17-4
TOI	4.15-35
Trace	4.10-1, 4.10-2
average	4.10-3
averaging	4.10-5
blank	4.10-4
Clear/Write	4.10-2
copy	4.10-8
freeze	4.10-4
math	4.10-14
max hold	4.10-2
min hold	4.10-5
position for 0 difference	4.10-14
power measurement	4.15-19
select	4.10-1
signal tracking	4.4-5
Trace info	3.5
Tracking generator	4.21-1
Transducer	
Activating	4.18-3
Entry	4.18-6
Transmission measurement	4.21-4, 4.22-3
Transmission parameters RS-232-C/COM	8.8
TRG (enhancement table)	3.6
Trigger	
external	4.9-2
external gate	4.9-4
free run	4.9-1
gated sweep	4.9-5
IF power	4.9-2
offset	4.9-2
RF power	4.9-8
slope	4.9-2
sweep	4.9-1
video	4.9-1
TV trigger	4.9-9

U

UNCAL	3.4
Unit	
level axis	4.6-2
limit line	4.16-8
Unit (key)	3.11
Universal command	8.5
Upper case	6.1-2
USB connection	8.11
User Interface	8.10

V

Vertical sync signal	4.9-9
Video bandwidth	4.7-3
Video polarity	4.9-10
Video triggering	4.9-1
VIEW (trace info)	3.5
View trace	4.10-4

W

WCDMA FDD BTS and MS	6.1-250
White space	5.14
Windows NT	1.19
administrator	1.19
login	1.19
password	1.19
Windows-XP Servicepacks	1.19

Z

Zero span	4.5-1
Zoom	4.12-7
amplitude	4.10-4
x-AXIS (gate signal)	4.9-6