

**TDSHT3
HDMI Compliance Test Software
Online Help**

Copyright © Tektronix. All rights reserved. Licensed software products are owned by Tektronix or its subsidiaries or suppliers, and are protected by national copyright laws and international treaty provisions.

Tektronix products are covered by U.S. and foreign patents, issued and pending. Information in this publication supersedes that in all previously published material. Specifications and price change privileges reserved.

TEKTRONIX and TEK are registered trademarks of Tektronix, Inc.

TDSHT3 HDMI Compliance Test Software Online Help Part Number, 076-0062-04

Contacting Tektronix

Tektronix, Inc.
14200 SW Karl Braun Drive
P.O. Box 500
Beaverton, OR 97077
USA

For product information, sales, service, and technical support:

- In North America, call 1-800-833-9200.
- Worldwide, visit www.tektronix.com to find contacts in your area.

Warranty 9(b)

Tektronix warrants that the media on which this software product is furnished and the encoding of the programs on the media will be free from defects in materials and workmanship for a period of three (3) months from the date of shipment. If any such medium or encoding proves defective during the warranty period, Tektronix will provide a replacement in exchange for the defective medium. Except as to the media on which this software product is furnished, this software product is provided "as is" without warranty of any kind, either express or implied. Tektronix does not warrant that the functions contained in this software product will meet Customer's requirements or that the operation of the programs will be uninterrupted or error-free.

In order to obtain service under this warranty, Customer must notify Tektronix of the defect before the expiration of the warranty period. If Tektronix is unable to provide a replacement that is free from defects in materials and workmanship within a reasonable time thereafter, Customer may terminate the license for this software product and return this software product and any associated materials for credit or refund.

THIS WARRANTY IS GIVEN BY TEKTRONIX WITH RESPECT TO THE PRODUCT IN LIEU OF ANY OTHER WARRANTIES, EXPRESS OR IMPLIED. TEKTRONIX AND ITS VENDORS DISCLAIM ANY IMPLIED WARRANTIES OF MERCHANTABILITY OR FITNESS FOR A PARTICULAR PURPOSE. TEKTRONIX' RESPONSIBILITY TO REPLACE DEFECTIVE MEDIA OR REFUND CUSTOMER'S PAYMENT IS THE SOLE AND EXCLUSIVE REMEDY PROVIDED TO THE CUSTOMER FOR BREACH OF THIS WARRANTY. TEKTRONIX AND ITS VENDORS WILL NOT BE LIABLE FOR ANY INDIRECT, SPECIAL, INCIDENTAL, OR CONSEQUENTIAL DAMAGES IRRESPECTIVE OF WHETHER TEKTRONIX OR THE VENDOR HAS ADVANCE NOTICE OF THE POSSIBILITY OF SUCH DAMAGES.

Table of Contents

About the TDSHT3 HDMI Compliance Test Software

TDSHT3 HDMI Compliance Test Software.....	1
---	---

Introduction

How to Use Online Help.....	3
Conventions.....	3
Feedback.....	3

Getting Started

Compatibility.....	5
Recommended Accessories.....	5
Requirements and Restrictions.....	6
Default Settings.....	7
How to Use the Software	
How to Start the Software.....	9
How to Minimize and Maximize the Software.....	12
How to Return to the Software.....	12
How to Exit the Software.....	12
Software Folders and File Names.....	13
Shortcut Keys.....	13
TDSHT3 HDMI Compliance Test Software Error Codes.....	15

Operating Basics

Software View	
TDSHT3 HDMI Compliance Test Software Window.....	23
TDSHT3 HDMI Compliance Test Software Interface Controls.....	23
Menus	
Menu Bar.....	24
File Menu.....	25
Tests Menu.....	26
Results Menu.....	26
Utilities menu.....	27
Help menu.....	28
Preferences.....	29
Selection pane.....	30
Result pane.....	31
Execution pane.....	33
Status bar.....	33

General Purpose Knob	34
Enable Remote Control of Test Equipment	
Enable Remote Control of Test Equipment	34
Configure and View Equipment Connections	38
Configure New IP Address for GPIB-ENET	40
Remote Control Caution	44
Remote GPIB Commands	
Remote GPIB Commands	46
Dialog Boxes	
Result Details.....	47
Virtual Keyboard.....	48
Exit	50

How to ...

Calculate Tbit	
Calculate Tbit	51
Deskew	
Deskew.....	54
DTG Pattern List	
Configure-DTG Pattern List	55
Select Which Tests to Run	
Source.....	56
Sink.....	57
Cable	58
Configure	
Source.....	58
Sink.....	60
Cable	61
Connect	
Source	
EDID Emulator for Source Tests.....	62
Eye Diagram (Source).....	63
Duty Cycle.....	66
Rise Time	69
Fall Time.....	72
Clock Jitter.....	75
Inter-Pair Skew.....	78
Setup 1.....	78
Setup 2.....	81
Differential Tests Select All	84
Intra-Pair Skew (Source).....	88
Setup 1.....	88

Setup 2.....	91
Low Amplitude +	94
Setup 1.....	94
Setup 2.....	97
Low Amplitude -	100
Setup 1.....	100
Setup 2.....	103
Sink	
Min/Max-Diff Swing Tolerance	106
Jitter Tolerance	111
Intra-Pair Skew (Sink).....	121
Cable	
Eye Diagram (Cable)	125
Setup diagram for TP1.....	125
Setup diagram for TP2.....	130
View Waveform	
Source	
Eye Diagram (Source).....	134
Duty Cycle	135
Rise Time	136
Fall Time	137
Clock Jitter.....	138
Inter-Pair Skew	139
Differential Tests Select All	140
Intra-Pair Skew (Source).....	141
Low Amplitude +	142
Low Amplitude -	143
Sink	
Min/Max-Diff Swing Tolerance	143
Jitter Tolerance	143
Intra-Pair Skew (Sink).....	144
Cable	
Eye Diagram (Cable)	144
Test	
Source	
Eye Diagram (Source).....	144
Duty Cycle	155
Rise Time	160
Fall Time	166
Clock Jitter.....	173
Inter-Pair Skew	182
Differential Tests Select All	188

Intra-Pair Skew (Source)	196
Low Amplitude +	201
Low Amplitude -	206
Sink	
Min/Max-Diff Swing Tolerance	211
Jitter Tolerance	216
Intra-Pair Skew (Sink)	223
Cable	
Eye Diagram (Cable)	229

Measurement Algorithms

Software CRU Technology	239
-------------------------------	-----

Test Methods

Source	
Eye Diagram	245
Duty Cycle	246
Rise/Fall Time	247
Clock Jitter	248
Inter-Pair Skew	249
Intra-Pair Skew	249
Sink	
Min/Max-Diff Swing Tolerance	250
Jitter Tolerance	251
Intra-Pair Skew	252
Cable	
Eye Diagram	252

HTML/MHT Reports

About HTML/MHT Reports	255
Reports Formats	255
Sample Report	256

Index

TDSHT3 HDMI Compliance Test Software

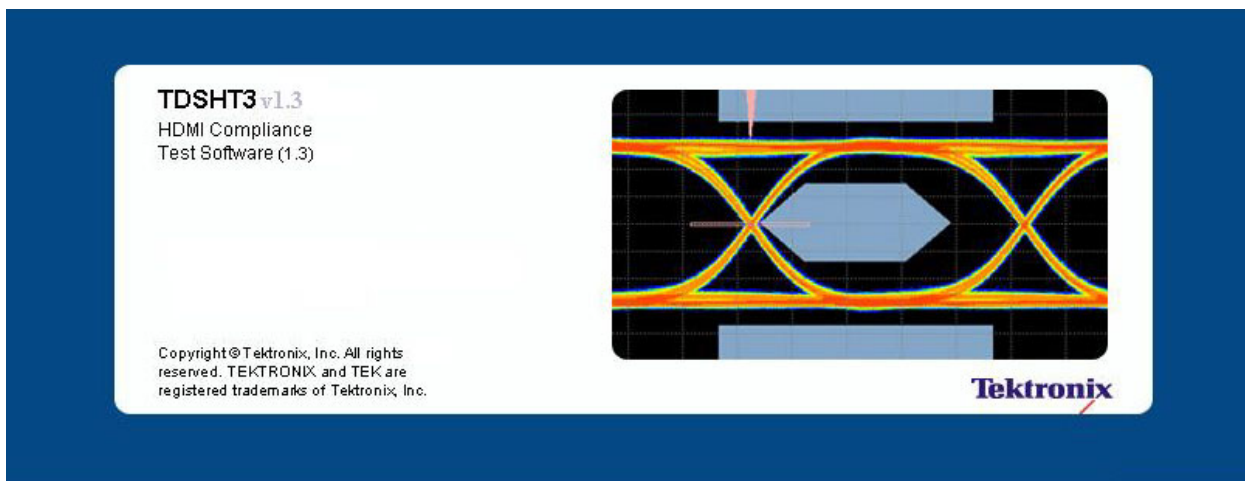

NOTE. *You will be provided with two TDSHT3 applications, one supporting CTS 1.2a specification displayed as TDSHT3 and the other supporting CTS 1.3b1 specification displayed as TDSHT3v1.3. Both of these applications can be loaded onto the oscilloscope but you can run only one application at a time.*

The TDSHT3 HDMI Compliance Test Software is a High Definition Multimedia Interface (HDMI) compliance test solution. This software helps the test, validation, and design engineers perform both HDMI physical layer validation and compliance testing. The TDSHT3 HDMI Compliance Test Software provides credible test results in conformance with the HDMI standards and test specifications.

The TDSHT3 HDMI Compliance Test Software offers automated tests for:

Source

- Differential Tests
 - [Eye Diagram](#) (Test ID 7-10)
 - [Duty Cycle](#) (Test ID 7-8)
 - [Rise Time](#) (Test ID 7-4)
 - [Fall Time](#) (Test ID 7-4)
 - [Clock Jitter](#) (Test ID 7-9)
 - [Inter-Pair Skew](#) (Test ID 7-6)
- Single-Ended Tests
 - [Intra-Pair Skew](#) (Test ID 7-7)
 - [Low Amplitude +](#) (Test ID 7-2)
 - [Low Amplitude -](#) (Test ID 7-2)

Sink

- Differential Tests
 - [Min/ Max-Diff Swing Tolerance](#) (Test ID 8-5),
 - [Jitter Tolerance](#) (Test ID 8-7)
- Single-Ended Tests
 - [Intra-Pair Skew](#) (Test ID 8-6)

Cable

- Differential Tests
 - [Eye Diagram](#) (Test ID 5-3)

The software offers automatic “one-button” testing that ensures faster validation with higher reliability and it supports only single-link HDMI device resolutions.

See Also

- Compatibility
- Requirements and Restrictions
- Recommended Accessories

How to Use Online Help

The online help system serves as a reference on how to use the TDSHT3 HDMI Compliance Test Software.

Contents: The Contents tab displays books and pages that represent the categories of information in the online help system.

Index: The Index tab displays a multi-level list of keywords and keyword phrases. These terms are associated with topics in the help system and direct you to specific topics.

Search: The Search tab enables you to search for keywords in the help system and to locate topics containing those words. When the search is completed, a list of topics is displayed so that you can select a specific topic to view.

To print a Help topic: Right-click the topic you want to print, and then click **Print**.

Conventions

Online help uses the following conventions:

- When steps require a sequence of selections by using the software interface, the “>” delimiter marks each transition between a menu and an option, for example, **File > Minimize**.
- Device under Test (DUT) refers to the HDMI Source, Sink, or Cable being tested.
- Two or more adjacent hyperlinks are separated by “|.”

The software uses the following convention:

- Three dots “...” next to any command means that the command opens a dialog box, which requires input.

Feedback

Tektronix values your feedback on our products. To help us serve you better, please send us your suggestions, ideas, or comments on the TDSHT3 HDMI Compliance Test Software.

Direct your feedback via e-mail to HDMIFeedback@tek.com or FAX at (503) 627-5695 and include the following information. Please be as specific as possible.

General information

- Instrument model number and hardware options, if any
- Probes used

- Your name, company, mailing address, phone number, FAX number, e-mail id
- Please indicate if you would like to be contacted by Tektronix about your suggestions or comments

Program specific information

- Software version number
- Description of the problem such that technical support can duplicate the problem
- The instrument setup file of the oscilloscope and the application are also required to identify the problem
- If possible, save the waveform on which you are performing the test as a `.wfm` file

NOTE. *To know the software version number, click **Help** > **About** in the software.*

Once you have gathered this information, you can contact technical support by e-mail. When you use e-mail, be sure to type in the subject line “TDSHT3 HDMI Compliance Test Software Problem,” and then attach the `.wfm` files.

Compatibility

For information on oscilloscope compatibility, refer to the *Optional Applications Software on Windows-Based Oscilloscopes Installation Manual*, Tektronix Part Number, 071-1888-XX. The manual is available as a PDF file.

Recommended Accessories

The following probes and test fixtures are recommended for TDSHT3 HDMI Software.

Supported Probes

- P7313SMA – 13 GHz recommended differential probe

The following probes can be used with old fixtures except for P7350SMA:

- P7350 – 5 GHz differential probe
- P7350SMA – 5 GHz differential probe
- P7330 – 4 GHz differential probe
- P6330 – 4 GHz differential probe
- P7380 – 8 GHz differential probe
- P7240 – 4 GHz single-ended probe

Supported Test Fixtures

- ET-HDMI-TPA-R , available from Efficere Technologies
- ET-HDMI-TPA-P , available from Efficere Technologies

The following test fixtures can only work for limited HDMI resolutions.

- HDMI-TPA-P-DI
- HDMI-TPA-P-SE
- HDMI-TPA-P-TDR
- HDMI-TPA-R-DI
- HDMI-TPA-R-SE
- HDMI-TPA-R-TDR

The fixtures are available under the Tektronix ordering system with the following part numbers:

- **ET-HDMI-TPA-S** – HDMI Type A fixture set for Tx, Rx, and Cable testing. It includes the following:
 - One HDMI-TPA-P plug board with SMA cables
 - One HDMI-TPA-R receptacle board with SMA cables
 - One HDMI-TPA-C calibration board with SMA cables
 - One HDMI-TPA-E, EEPROM board, 29 SMA to GPPO cables two inches long
- **ET-HDMI-TPA-STX** – HDMI Type A fixture set for Tx testing only. It includes the following:
 - One HDMI-TPA-P plug board with 10 GPPO to SMA cables two inches long
 - One HDMI-TPA-E, EEPROM board
- **ET-HDMIC-TPA-S** – HDMI Type C fixture set for Tx, Rx, and Cable testing. It includes the following:
 - One HDMI-TPA-P plug board with SMA cables
 - One HDMI-TPA-R receptacle board with SMA cables
 - One HDMI-TPA-C calibration board with SMA cables
 - One HDMI-TPA-E, EEPROM board, 29 SMA to GPPO cables two inches long
- **ET-HDMIC-TPA-STX** - HDMI Type C fixture set for Tx testing only. It includes the following:
 - One HDMI-TPA-P plug board with 10 GPPO to SMA cables two inches long
 - One HDMI-TPA-E, EEPROM board

Connectivity

- GPIB (recommended for DPO/DSA70000 series oscilloscope)
- USB-GPIB (HS)
- E-Net Switch

Requirements and Restrictions

- TekVisa must be installed on the oscilloscope. If you do not have TekVISA, you can download it from www.tektronix.com/software.
- If the signal is not connected and the noise level is less than 50 mV, then the software detects and displays a message such as “Improper Waveform.”

NOTE. Do not change the oscilloscope settings when the test runs. If you change the settings when the test runs, the software may give abnormal test results.

For Better and Reliable Results

- Before you run any test, calibrate the probes and oscilloscope for Signal Path Compensation. On the oscilloscope menu bar, click **Utilities** > **Instrument Calibration** and then click **Calibrate** to calibrate the oscilloscope.
- If the signal is not connected and the noise level is less than 50 mV, then the software detects and gives a message such as “Invalid Signal.”

Default Settings

Parameter	Selection	Default setting
Select	Flow Controls	Select
	Device Type Tab	Source (Differential Tests)
	Source Test	Eye Diagram
	Sink Test	Min/Max-Diff Swing Tolerance (Differential)
	Cable Test	Eye Diagram
Source Configuration	Clock Input	Ch1
	Data0 Input	Ch2
	Data1 Input	Ch3
	Data2 Input	Ch4
CRU	Clock	PLL
Others	Ref Level Units	Percentage
Sink Configuration	DTG file path	C:\TekApplications\TD-SHT3v1-3\ComplianceTest-Patterns\ PC\1920X1080i 50Hz 8 Bit Gray RGB PC v3-3.dtg
	Clock output from DTG	A1
	Data0 output from DTG	B1
	Data1 output from DTG	B2
	Data2 output from DTG	C1
Signal Sources	Signal Sources Tab	DTG AWG Unavailable AFG Unavailable
	Control Type	GPIB
	Board Type	GPIB0
	GPIB Address (Primary)	1
	GPIB Address (Secondary)	0
	View Waveform	Clock/Data Waveforms

Parameter	Selection	Default setting
Result Summary	View Jitter Plot	Unavailable
	View Eye Plot	Unavailable
	Data Lane	Unavailable
	Test Point	Unavailable
Result Details	View Jitter Plot	Unavailable
	View Eye Plot	Unavailable
	Result Statistics	Unavailable
Deskew	External	From Input Setup - Input - Ch1
		From Input Setup - Hysteresis - 10%
		From Input Setup - Ref Level - 50%
		To Input Setup - Input - Ch2
		To Input Setup - Hysteresis - 10%
		To Input Setup - Ref Level - 50%
	Internal	Slope - Rise
		Slope - # of Slopes - 1
		From Input Setup - Input - Ch1
		To Input Setup - Input - Ch2
		Slope - Rise
Report Configuration pane	Device Details	HDMI Device
	Resolution	1920*1080i
	Refresh Rate	60Hz
	Report File	Disabled
	Auto Increment	Selected
	Save As	Disabled
	Clear Report	Enabled

How to Start the Software

When you start the software, a warning message box may appear.

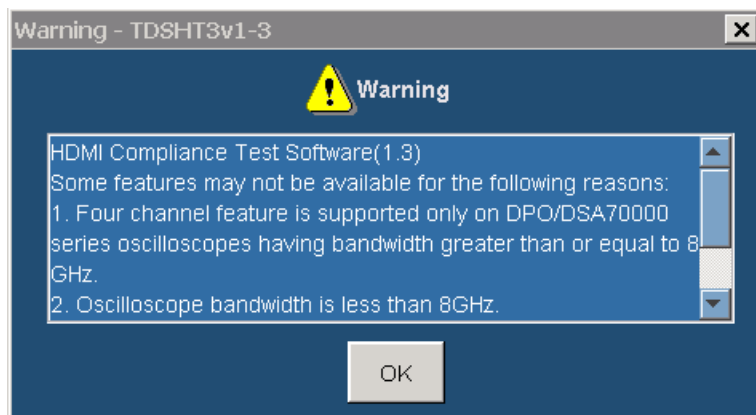

This happens due to the following reasons:

- 1. Four channel feature is supported only on DPO/DSA70000 series oscilloscopes having bandwidth greater than or equal to 8 GHz.** For TDS series oscilloscopes, only two channels are available and the other two channels are displayed as **Not Conn**.
- 2. Oscilloscope bandwidth is less than 8 GHz.** For higher resolution HDMI signals, you need at least a 8 GHz oscilloscope. Your oscilloscope bandwidth is less than 8 GHz.
- 3. Maximum available record length for two channels is less than 16 M.** For HDMI compliance testing, you need at least 16 M record length in two channels. This 16 M record length is installed in the following oscilloscopes:
 - Option 4M and above in TDS series oscilloscopes
 - Option 2XL and above in DPO series oscilloscopes

If these options are not available (installed) in the oscilloscope, the software will run the Eye diagram and Jitter measurements with the maximum available record length.

Depending on the type of oscilloscope that you have, you can start the software in different ways.

1. For supported B-series oscilloscopes, select **App > HDMI Compliance Test Software(1.3)**.

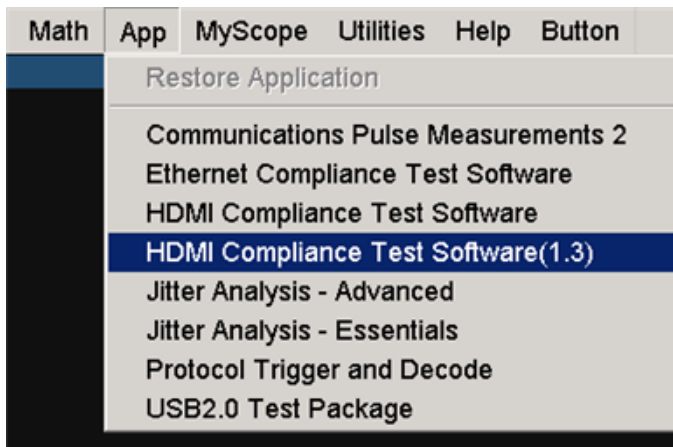

2. For TDS7000-series oscilloscopes, select **File > Run Application > HDMI Compliance Test Software(1.3)**.

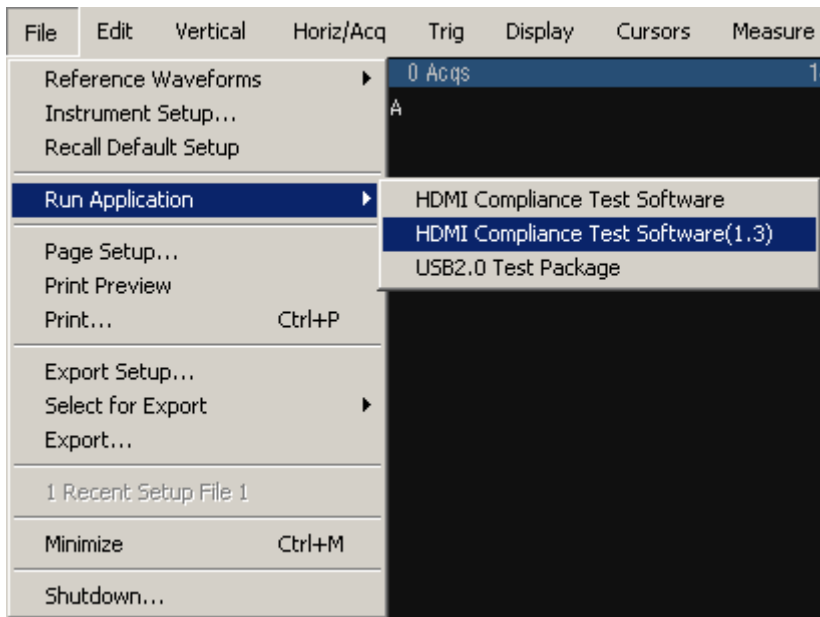

3. For DPO70000-series and DSA70000-series oscilloscopes, select **Analyze > HDMI Compliance Test Software(1.3)**.

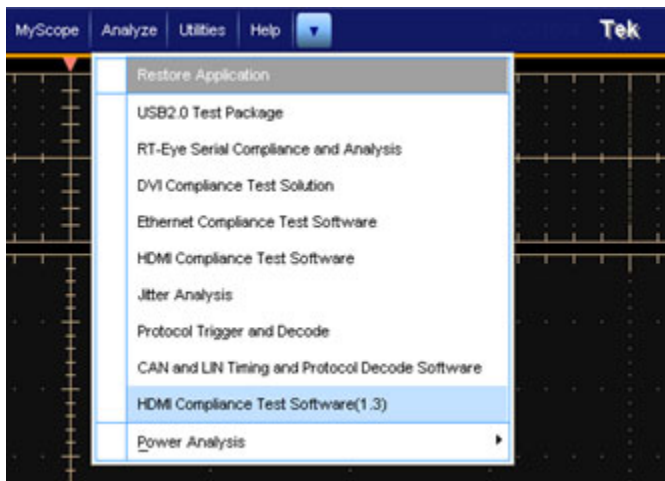

4. A splash screen indicates that the software loading is in progress.

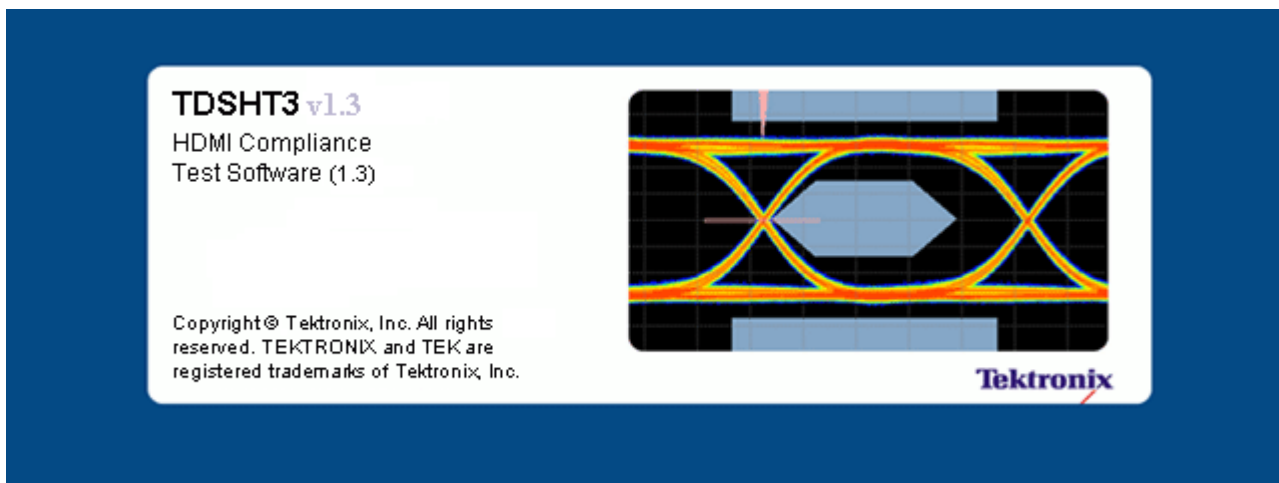

5. The oscilloscope display resizes to fit in the upper part of the screen. The lower part of the oscilloscope screen displays the TDSHT3 HDMI Compliance Test Software.

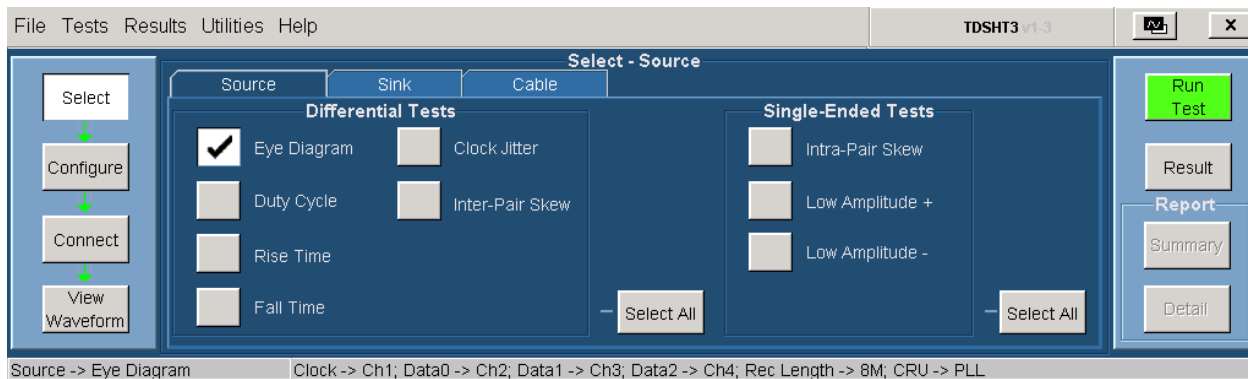

6. The software is automatically set to its [default settings](#).
7. If you gain access to the oscilloscope functions, then the oscilloscope display appears full screen and the TDSHT3 HDMI Compliance Test Software recedes to the background.

How to Minimize and Maximize the Software

The software appears even when you minimize the oscilloscope display.

- To minimize the software, click **File > Minimize**. The TDSHT3 HDMI Compliance Test Software window minimizes to the Windows taskbar. The upper part of the screen has the oscilloscope display and the lower part of the screen has the desktop.
- To restore the minimized window to its previous size, click its taskbar button.
- To hide the window, click **Hide**  on the top-right of the software window.

NOTE. *If you click **Hide**, the TDSHT3 HDMI Compliance Test Software window goes to the background and the oscilloscope fills the display.*

How to Return to the Software

When you gain access to the oscilloscope functions, the oscilloscope fills the display. You can gain access to the oscilloscope functions in the following ways:

- Choose either the menu bar or the toolbar mode on the oscilloscope, and then gain access to the menus.
- Click **App > Restore Application** for B-series, click **Analyze > Restore Application** for DPO70000/DSA70000 series, or click **APP**  on the top right of the TDS7000 series oscilloscope display to return to the software.

See Also

- Exit

How to Exit the Software

To quit the software:

- On the menu bar, click **File > Exit**.
- The Exit dialog box appears.

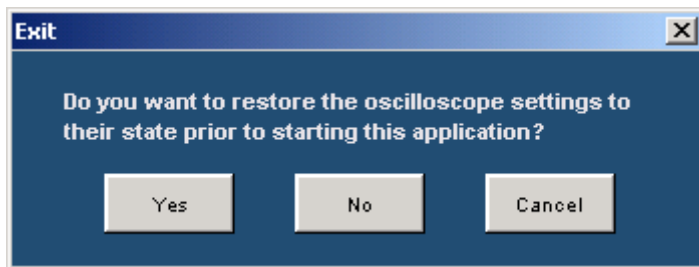

- Click either **Yes**, **No**, or **Cancel**. Yes is selected by default. When the software runs, it automatically changes some oscilloscope settings. When you quit the software, you can choose whether to retain these settings or restore the previous settings.

NOTE. Using other methods to quit the software may result in an abnormal termination of the software.

Software Folders and File Names

The TDSHT3 HDMI Compliance Test Software uses file name extensions to identify the file type. The following table lists the default folder names and their purpose:

Folder	Purpose
C:\TekApplications\TDSHT3v1-3	This is the software data folder.
C:\TekApplications\TDSHT3v1-3\Images	This folder stores all the images.
C:\TekApplications\TDSHT3v1-3\Data	This folder stores all the software data.
C:\TekApplications\TDSHT3v1-3\setup	This folder stores all the save and recall files.
C:\TekApplications\TDSHT3v1-3\Demo Tools	This folder stores the demo waveforms.
C:\TekApplications\TDSHT3v1-3\Reports	This folder stores the reports.

Shortcut Keys

Menu	Shortcut key
File	Alt+F
Tests	Alt+T
Results	Alt+R
Utilities	Alt+U
Help	Alt+H
File > Recall Compliance Default	Alt+F+D
File > Recall	Alt+F+R
File > Recall > First Recent	Alt+F+E+1

Menu	Shortcut key
File > Recall > Second Recent	Alt+F+E+2
File > Recall > Third Recent	Alt+F+E+3
File > Recall > Fourth Recent	Alt+F+E+4
File > Save	Alt+F+S
File > Recall Recent	Alt+F+E
File > Preferences	Alt+F+P
File > Preferences > Position Eye Mask in Center	Alt+F+P+M
File > Preferences > Acquisition Alert Message	Alt+F+P+A
File > Preferences > Jitter Tolerance (No calibration)	Alt+F+P+J
File > Preferences > Single Ended (With 50ohm term)	Alt+F+P+S
File > Preferences > Set the probe control to internal 3.3 V	Alt+F+P+C
File > Minimize	Alt+F+M
File > Exit	Alt+F+X
Tests > Select	Alt+T+S
Tests > Select > Source	Alt+T+S+S
Tests > Select > Sink	Alt+T+S+K
Tests > Select > Cable	Alt+T+S+C
Tests > Configure	Alt+T+C
Tests > Connect	Alt+T+N
Tests > View Waveform	Alt+T+V
Results > Summary	Alt+R+S
Results > Details	Alt+R+D
Utilities > Deskew	Alt+U+D
Utilities > DTG Pattern List	Alt+U+P
Help > Help Topics	Alt+H+T
Help > About HDMI	Alt+H+A

TDSHT3 HDMI Compliance Test Software Error Codes

The following table lists the error codes, their descriptions, and the possible solutions:

Error code	Error message	Description	Possible solution
101	Input is "Not Conn."	Both the selected sources are not connected.	Select valid channels (Ch1-Ch2, Ref1-Ref2) for at least clock/data source/data source (differential tests) or for input1/input2 (single-ended tests).
102	Conflict in the selection of inputs.	The sources that are selected for the two inputs are the same. The inputs clock source and data source for differential tests, input 1 and input 2 for single-ended tests.	Select different channel sources for input 1 and input 2 for single-ended tests and different channel sources for clock source and data source for differential tests.
103	The combination of Ref and Live input signals is not valid.	The software supports both Ref or both Live combinations of channels.	Select both ref channels or both live channels for clock and data source.
104	Ref Wfm is not valid.	The software cannot switch on ref waveforms. Ref waveforms could be empty.	Recall the required ref waveform from the appropriate file on the oscilloscope.
105	Conflict in GPIB Selection.	There is a conflict in the selection of GPIB address. One or more addresses are repeated.	Ensure that no two GPIB addresses are identical.
106	Conflict in the selection of input types.	There is a conflict in the selection of the inputs. One or more inputs are repeated.	Ensure that the combination of the selected inputs are unique.
107	Four channel feature is supported only on DPO/DSA70000 series oscilloscopes having bandwidth greater than or equal to 8 GHz.	The four channel feature is not supported in the oscilloscope.	Reduce the number of channels to two and proceed.
110	Unable to acquire waveform.	The oscilloscope is not able to acquire the signal and trigger.	Ensure that the software configurations are proper. Check the probes and test fixture connections. If the test uses serial trigger, ensure that the CTL pattern is present on the waveform.

Error code	Error message	Description	Possible solution
111	Not enough acquisitions to perform the test.	The software expects to acquire a minimum number of acquisitions that are configured.	Ensure that the software configurations are proper. Check the probes and test fixture connections.
113	Error in importing the Wfm.	The software could not import the waveform from acquisition. This happens when there is no valid waveform in the acquisition memory.	Check the probes and test fixture connections. Run the test again.
114	Improper Wfm.	Signal is not probed at the proper test points.	Refer to the connections diagram and probe the proper signal.
115	Ref Wfms have different Record Lengths/Sample Rates.	The ref waveforms have different sample rates and/or record lengths.	Use waveforms that are acquired simultaneously for ref waveforms.
121	Ref Levels entered are outside the range of the Wfm.	Unable to locate the edges on the waveform at the transition because the levels configured do not fall within the transition of the waveform.	Enter the Ref Level voltage value where the transition occurs on the waveform. Enter 50 percent of the level of the peak-to-peak transition level for mid-ref levels, 80 percent of the peak-to-peak for high-ref levels, and 20 percent of the peak-to-peak for low ref levels.
122	$((\text{Hysteresis Level}/2) + \text{Ref Level})$ cannot be greater than 100 percent.	$((\text{Hysteresis Level}/2) + \text{Ref Level})$ has to be within 100 percent for edge finding.	Set both the ref and $(\text{Hysteresis Level}/2)$ to be less than 100 percent.
123	High Level is less than or equal to Low Level.	The configured high level value is less than the low level value.	Configure the high level to be greater than the low level.
131	Error in calculating Tbit.	Not a valid clock waveform.	Supply a valid clock waveform and run the test again.
132	Clock input is required to calculate Tbit.	The Tbit value has to be calculated before you run a test that uses only data source(s).	<ol style="list-style-type: none"> 1. Select and run a test that uses clock source for Tbit value. 2. Click Connect, select clock source, and then click Re-calculate Tbit before you run the test.
152	Select any test to continue.	Configure, Connect, View Waveform, and Run Test need at least one test to be selected.	Select at least one test before you click either Configure , Connect , View Waveform , or Run Test .

Error code	Error message	Description	Possible solution
161	Unable to recover clock.	Improper waveform or the software components are missing.	Supply the proper waveform. Reinstall the software.
171	Unable to find edges.	The waveform may be noisy or the hysteresis level may be low.	Check the probes and test fixture connections. Increase the hysteresis band level.
172	Not enough edges.	Number of edges found on the waveform is less than the minimum number of edges that is required for the test.	Decrease the horizontal scale to have more complete cycles of the waveform. Adjust the hysteresis level of the signal to find the edge at the required level.
173	Unable to calculate skew.	Could not find the mid of the waveform.	Check the probes and test fixture connections.
174	CTL pattern not found.	The CTL pattern 0010101011 was not found on the waveform.	Ensure that the appropriate pattern is present on the source waveform. Change the polarity of the waveform.
175	Option ST is not installed on the oscilloscope.	Option ST is not available on the oscilloscope.	Install Option ST.
178	Unable to calculate Vswing.	Signal is not probed at the proper test points.	Follow the instructions in the setup diagram and probe the proper signal.
181	Check the DTG connection.	DTG connection has failed. This could happen if: <ul style="list-style-type: none"> ■ The DTG is not switched on. ■ There is a mismatch in the GPIB-ENET configuration, software GPIB configuration, or DTG remote control configuration. ■ The GPIB cable is not connected properly. 	<ul style="list-style-type: none"> ■ Switch on the DTG and wait for the DTG software to load. ■ Check GPIB connections. ■ Ensure that the primary and secondary addresses of DTG in the remote control match the GPIB-ENET configuration of the oscilloscope. ■ Ensure that the GPIB-ENET configuration on your oscilloscope matches the signal sources configuration in the software.

Error code	Error message	Description	Possible solution
182	File not found in the DTG.	The configured file is not found in the DTG.	Ensure that the specified file in the software is present in the DTG. Specify a file name that is present in the DTG.
183	Invalid logical channel.	The logical channel is invalid.	Provide a proper logical channel.
184	Conflict in selection of outputs from the DTG.	The same physical channel (A1, A2, B1, B2, C1, C2, D1, D2) is selected for any two logical channels (Clock, Data0, Data1, Data2).	Select different physical channels (A1, A2, B1, B2, C1, C2, D1, D2) for a given logical channel (Clock, Data0, Data1, Data2).
191	Check the AWG connection.	AWG connection has failed. This could happen if: <ul style="list-style-type: none"> ■ The AWG is not switched on. ■ There is a mismatch in the GPIB-ENET configuration, application GPIB configuration, and AWG remote control configuration. ■ The GPIB cable is not connected properly. 	Switch on the AWG and wait for the AWG software to load. Check GPIB connections. Ensure that the primary address of AWG in the Utility > Network > Address matches with the GPIB-ENET configuration of the oscilloscope. Ensure that the GPIB-ENET configuration on your oscilloscope matches the signal sources configuration in the software.
192	File not found in the AWG.	File is not present in the AWG.	Ensure that the required file is present in the AWG.

Error code	Error message	Description	Possible solution
193	Check the Signal Sources connection.	<p>Signal sources connection has failed. It may be due to DTG or AWG connection failure. DTG connection has failed. This could happen if:</p> <ul style="list-style-type: none"> ■ The DTG is not switched on. ■ There is a mismatch in the GPIB-ENET configuration, software GPIB configuration, and DTG remote control configuration. ■ If the GPIB cable is not connected properly. <p>AWG connection has failed. This could happen if:</p> <ul style="list-style-type: none"> ■ The AWG is not switched on. ■ There is a mismatch in the GPIB-ENET configuration, software GPIB configuration, and AWG remote control configuration. ■ If the GPIB cable is not connected properly. ■ Primary addresses of DTG and AWG are same. 	<p>For DTG connection failure:</p> <ul style="list-style-type: none"> ■ Switch on the DTG and wait for the DTG software to load. ■ Check the GPIB connections. ■ Ensure that the primary address of DTG in the remote control matches the GPIB-ENET configuration of the oscilloscope. ■ Ensure that the GPIB-ENET configuration on your oscilloscope matches the signal sources configuration in the software. <p>For AWG connection failure:</p> <ul style="list-style-type: none"> ■ Switch on the AWG and wait for the AWG software to load. ■ Check the GPIB connections. ■ Ensure that the primary address of AWG in the Utility > Network > Address matches with the GPIB-ENET configuration of the oscilloscope. ■ Ensure that the GPIB-ENET configuration on your oscilloscope and signal sources configuration in the software match. <p>Select distinct primary addresses for DTG and AWG.</p>
194	Jitter value is unavailable.	Signal is not probed at the proper test points.	Follow the instructions in the setup diagram and probe the proper signal.

Error code	Error message	Description	Possible solution
196	Invalid DUT frequency.	The frequency of the DUT configured in Configure > Setup > DUT Freq (MHz) does not match with the frequency of the signal generated from the DTG.	Load the required pattern on the DTG and check the frequency of the signal. Ensure that the same frequency has been configured in the DUT Freq (MHz).
201	Edges on the Wfm are lesser than the configured number of edges.	Deskew number of edges set by the user to perform the deskew is not available on the waveform.	Ensure that the edges in the waveform and the display in the numeric input are the same. Adjust the horizontal scale to increase the number of transitions that is required to adjust the deskew.
202	Calculated skew is greater than the oscilloscope skew range.	The calculated skew value is greater than the oscilloscope deskew range.	The deskew will be done to the maximum deskew value that is applicable to the oscilloscope.
203	Cycle has less than 20 sample points.	Insufficient number of samples in a complete cycle. The number of data points in the identified cycle is less than 20.	Increase the sampling rate.
211	Select the test point(s) to continue.	No test points are selected.	Select any one or both of the test points in cable configuration.
221	Mask cannot be moved beyond this position.	Upper and lower masks have exceeded their boundary values. The mask co-ordinates are beyond the plottable area.	Change the Mask Movement mode from Coarse to Fine. After changing to Fine, you will be able to move a bit further. If you are already in Fine mode, and this message appears, then you are in the maximum/minimum possible position.
222	Unable to calculate mask margins.	An error occurred while calculating the mask margins.	The signal may be wrong (noise, invalid pattern). Connection to the probe tip may be loose. Recheck the connection and run the test again.

Error code	Error message	Description	Possible solution
251	Check the AFG connection.	<p>Connection to AFG has failed. This could happen if:</p> <ul style="list-style-type: none"> ■ The AFG is not switched on. ■ There is a mismatch in the GPIB-ENET configuration, software GPIB configuration, and AFG remote control configuration. ■ If the GPIB cable is not connected properly. ■ Primary addresses of the signal sources are same. 	<p>Perform the following:</p> <ul style="list-style-type: none"> ■ Switch on the AFG and wait for the AFG software to load. ■ Check the GPIB connections. ■ Ensure that the primary address of AFG in the remote control matches the GPIB-ENET configuration of the oscilloscope. ■ Ensure that the GPIB-ENET configuration on your oscilloscope matches the signal sources configuration in the software. ■ Select distinct primary addresses for the signal sources.
252	Four DTGM30 modules are required to run this measurement.	An error occurs when any of the four connected modules is not DTGM30.	Connect four DTGM30 modules to the DTG and run the test.
401	AWG pattern directory not found.	The required directory is not present in the AWG.	Reinstall the AWG pattern files.
402	Unable to turn on the AWG output due to invalid external input clock. Connect the external clock and turn ON the outputs to proceed.	Invalid/missing external clock.	Ensure that the correct external clock is connected before turning ON the outputs.

TDSHT3 HDMI Compliance Test Software Window

The software window includes a menu bar, selection pane, test selection pane, execution pane, and status bar. The client pane changes between the selection pane, configuration pane, connection pane, and view waveform pane depending on what you have selected in the selection pane. After you run the test, the client pane automatically changes to the result pane.

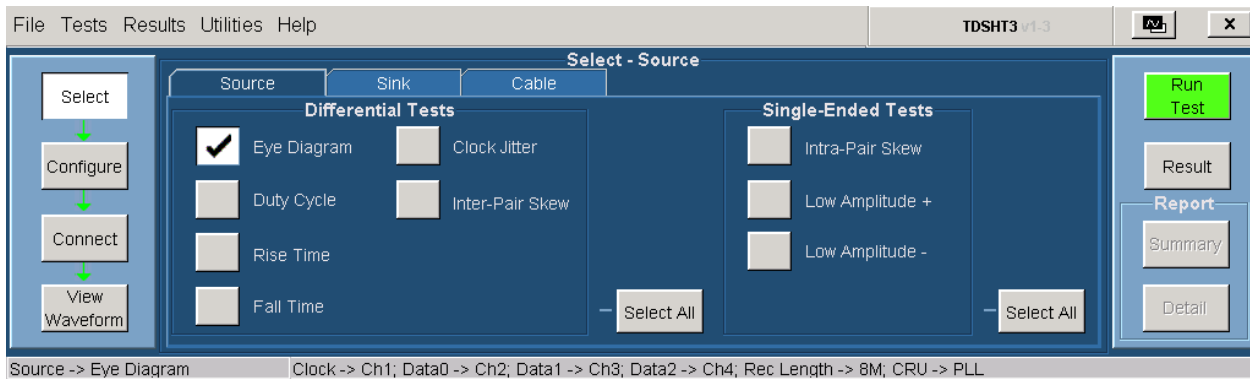

TDSHT3 HDMI Compliance Test Software Interface Controls

The software uses a Windows interface.

NOTE. *The oscilloscope software shrinks to fit in the top part of the display when the TDSHT3 HDMI Compliance Test Software runs.*

The software interface uses the following controls:

Control	Description
Menu bar	The Menu bar provides access to the software menus. It is located at the top of the software window.
Area/Tab	An Area/Tab control encloses visual frame with a set of related options.
Option button	An Option button allows you to select either a command or a task.
Drop-down list box	A Drop-down list box lists items from which you can select one item.
Field	A Field is a box where you can enter text or values.

Control	Description
Check boxes	You can select or clear check boxes that you use to set preferences.
Scroll bar	A Scroll bar is a vertical or horizontal bar at the side or bottom of a display area that is used to move around that area.
Browse	Browse refers to the window where you can browse through a list of folders and files.
Command button	A Command button refers to the usually rectangular button that carries out a command and may initiate immediate action.
Numeric keypad	You can use a Numeric keypad to enter numeric values.
Text keypad	You can use a Text keypad to enter text.
MP/GP knob	A line between the knob icon and the field indicates which knob you can turn on the oscilloscope to select a value.
F1	F1 help opens help on a topic associated with the currently selected item in your software.

Menu Bar

The menu bar consists of the following menus:

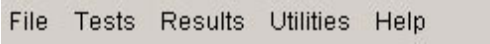

File Tests Results Utilities Help

Click these links for information on each of the menus.

- [File menu](#)
- [Tests menu](#)
- [Results menu](#)
- [Utilities menu](#)
- [Help menu](#)

File Menu

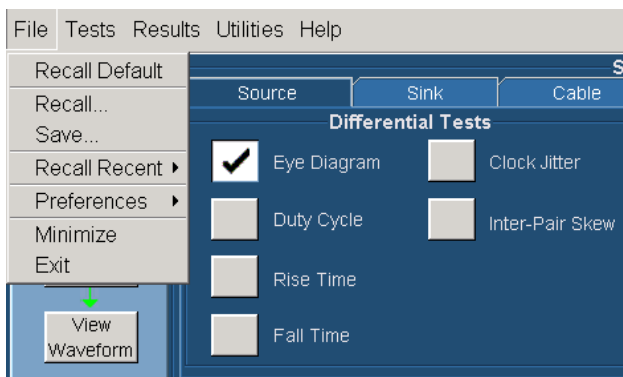

Menu selection	Description
Recall Default	Click File > Recall Default to recall the default settings for both the software and the oscilloscope.
Recall	Click File > Recall to recall the previously saved settings for the software from an <code>.ini</code> file.
Save	Click File > Save to save the software settings to an <code>.ini</code> file.
Recall Recent	Click File > Recall Recent to select among the recently saved and recalled setups.
Preferences	Click File > Preferences to select one of the following options. Click an option again to clear the selection. <ul style="list-style-type: none"> ■ Position Eye Mask in Center ■ Acquisition Alert Message ■ Jitter Tolerance (No calibration) ■ Single Ended (With 50ohm term) ■ Set the probe control to internal 3.3 V
Minimize	Click File > Minimize to minimize the software window.
Exit	Click File > Exit to quit the software.

Click these links for information on the other menus.

- [Help menu](#)
- [Results menu](#)
- [Tests menu](#)
- [Utilities menu](#)

Tests Menu

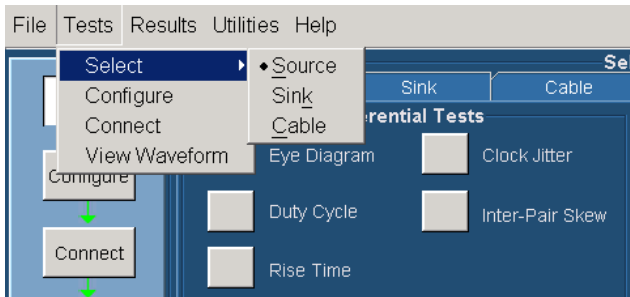

Menu selection	Description
Select	Click Tests > Select to display or modify the test selection for Source, Sink, or Cable in the client pane.
Configure	Click Tests > Configure to display or modify the configuration parameters for the selected test(s).
Connect	Click Tests > Connect to display the connection instructions for the selected test(s).
View Waveform	Click Tests > View Waveform to display a sample waveform or waveforms based on the settings for the selected test(s).

Click these links for information on the other menus.

- [File menu](#)
- [Help menu](#)
- [Results menu](#)
- [Utilities menu](#)

Results Menu



Menu selection	Description
Summary	Click Results > Summary to display the result summary of the last test(s) that you conducted.
Details	Click Results > Details to display the detailed results of the last test(s) that was conducted.

Click these links for information on the other menus.

- File menu
- Help menu
- Tests menu
- Utilities menu

Utilities menu

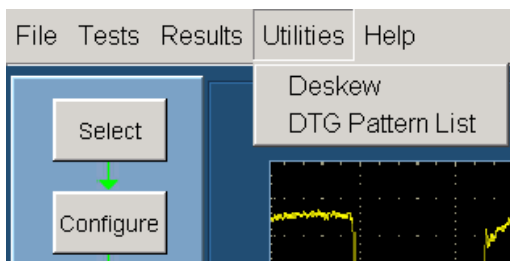

Menu selection	Description
Deskew	Click Utilities > Deskew to open the deskew pane. The deskew pane allows you to compensate the skew between the oscilloscope channels.
DTG Pattern List	Click Utilities > DTG Pattern list to open the DTG Pattern list pane. The DTG pattern list allows you to add and delete DTG pattern files.

Click these links for information on the other menus.

- File menu
- Help menu
- Results menu
- Tests menu

Help menu

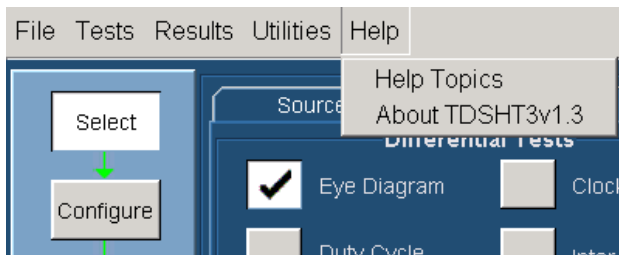

Menu selection	Description
Help Topics	Click Help > Help Topics to display the help file for the TDSHT3 HDMI Compliance Test Software.
About TDSHT3	Click Help > About TDSHT3 to display a dialog box with information about the current TDSHT3 HDMI Compliance Test Software.

Click these links for information on the other menus.

- [File menu](#)
- [Results menu](#)
- [Tests menu](#)
- [Utilities menu](#)

Preferences

On the menu bar, click **File > Preferences** to select any of the options described in the following table. Click an option again to clear the selection.

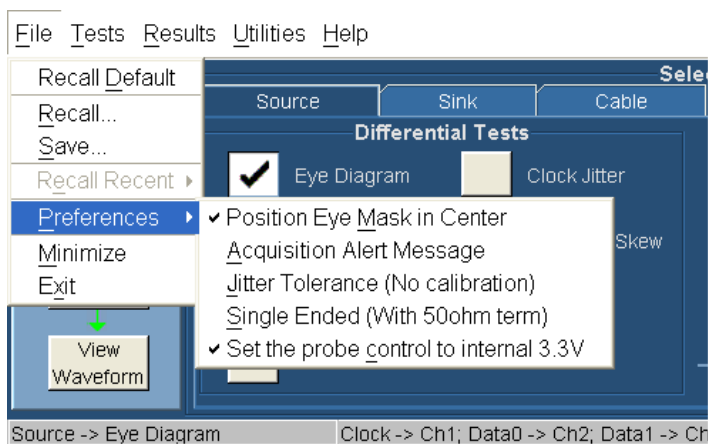

Option	Description
Position Eye Mask in Center	Select this option to position the mask at the center of the eye diagram. Clear this option to position the mask to the left of the eye diagram.
Acquisition Alert Message	Select this option to receive an alert message that allows the software to use the custom oscilloscope setup. Clear this option to stop receiving the alert message.
Jitter Tolerance (No calibration)	Select this option if you do not want to run the jitter calibration tests for sink jitter tolerance measurements.
Single Ended (With 50 Ω term)	This option can be selected only when the negative input of the probe is terminated with the 50 Ω terminator. When this option is selected, the single ended measurements will be performed as though 50 Ω termination is connected.
Set the probe control to internal 3.3 V	This option is applicable to Source measurements on DPO/DSA oscilloscopes with P7313 probes. When this option is selected, the application sets the probe control to internal and voltage to 3.3 V.

Selection pane

The selection pane, which is located to the left of the software window, allows you to navigate through the software.

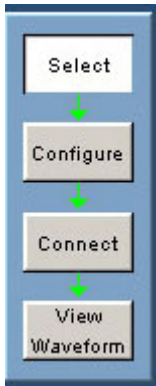

The following table lists the buttons and their task descriptions:

Button name	Description
Select	Click Tests > Select to display or modify the test selection for Source, Sink, or Cable in the client pane.
Configure	Click Tests > Configure to display or modify the configuration parameters for the selected test(s).
Connect	Click Tests > Connect to display the connection instructions for the selected test(s).
View Waveform	Click Tests > View Waveform to display a sample waveform or waveforms based on the settings for the selected test(s).

Result pane

The result pane, which is located at the center of the software window, appears as shown in the following figure:

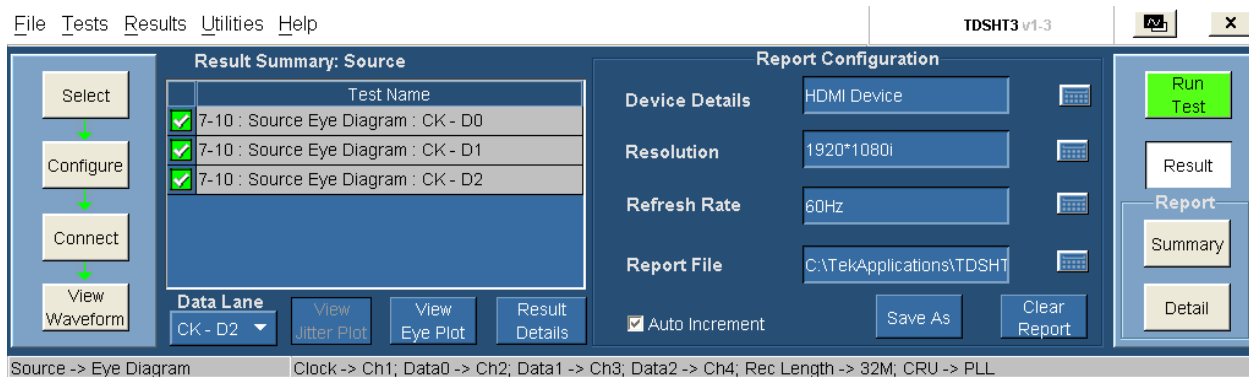

The result pane includes the result summary pane and the report configuration pane.

Result Summary pane

The result summary pane displays the test results.

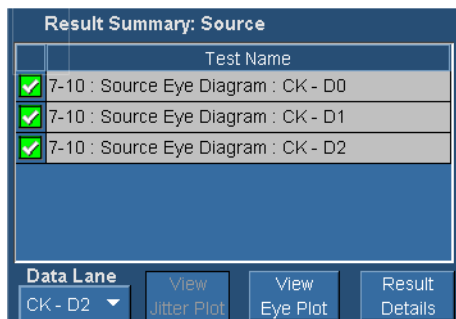

This icon indicates that the test has passed.

This icon indicates that the test has failed.

This icon indicates that the test could not be run due to an error.

Option	Description
Status	The status icons display the status of the test as Pass, Fail, or Error.
Test Name	The Test Name box displays the test id, test name, and selected lanes.

Option	Description
Data Lane	Select the data lane pair for which to display the corresponding eye diagram plot.
View Jitter Plot	Click View Jitter Plot to display the jitter plot. This option is available if you have successfully run the clock jitter test.
View Eye Plot	Click View Eye Plot to display the eye plot. This option is available if you have successfully run the eye diagram test.
Result Details	Click Result Details to display the Result Details dialog box that shows the details of test results categorized as test name, specification range, measured value, result, and remarks.

Report Configuration pane

You can set the report details to identify and generate the report automatically. You can also set a default report file.

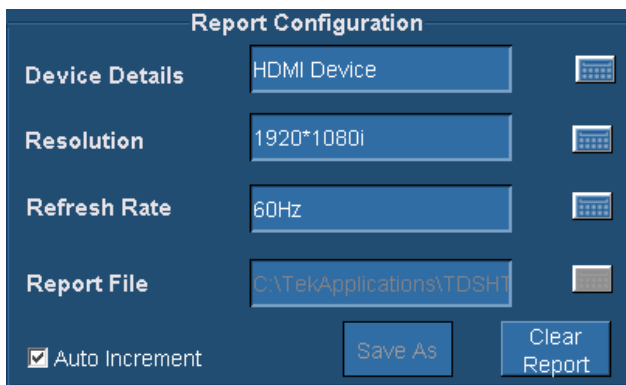

In the report configuration pane, you can configure the following parameters:

Category	Description
Device Details	The Device Details box allows you to specify the device-related information on which the test is conducted.
Resolution	The Resolution box allows you to specify the resolution on which the test is conducted.
Refresh Rate	The Refresh Rate box allows you to specify the refresh rate at which the test is conducted.
Report File	The Report File box allows you to specify the path and the file where the generated report will be saved. However, a default file name and path already exists.
Auto Increment	Select the Auto Increment check box to generate a new report. Selecting this option does not overwrite the existing report. However, it adds the date and time to the existing file name.

Category	Description
Save As	Click Save As to save the generated reports. The Save File dialog box is displayed. You can enter a file name and save the report.
Clear Report	Click Clear Report to clear all the results and records of the earlier tests.

Execution pane

The execution pane, which is located to the right of the software window, displays the Run Test and Result buttons. After you successfully run a test, the Summary and Detail buttons are available.



Click each button to perform a particular task. The following table lists the buttons and their task descriptions:

Button name	Description
Run Test	Click Run Test to run the selected test or tests.
Result	Click Result to display the result pane that shows the test results.
Summary	Click Summary to generate a report summary as a .csv file.
Detail	Click Detail to generate the HTML/MHT report. Plots and waveforms are displayed where ever applicable.

Status bar

At the bottom of the software window is the status bar, which displays the selected test and the important configuration parameters.

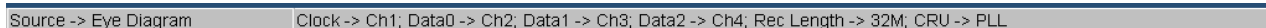

General Purpose Knob

To use the General-Purpose knob, follow these steps:

1. Click any number box to display the connection to one of the general purpose knobs.
2. Turn the corresponding knob on the oscilloscope front panel to adjust the value for the selected parameter.
3. For better resolution, press the **Fine** button.

Enable Remote Control of Test Equipment

Three methods are available to connect to an AWG, DTG, or AFG. The methods are GPIB-GPIB (recommended), GPIB-USB, and GPIB-ENET.

The following section will guide you through the process of connecting the AWG, DTG, AFG, and the digital oscilloscope used for Sink and Cable tests:

You will need Tektronix AWG7000 series, AFG3000, Tektronix DTG5274/DTG5334, Tektronix supported oscilloscope, National Instruments GPIB-USB-B with the included software, NI-GPIB-HS cable with the included software, and NI-488.2 for Windows.

NI-488.2 Software configuration for TDS series

1. Ensure that NI-VISA is NOT installed.
2. Install NI-488.2 for Windows (version 2.1 or later).

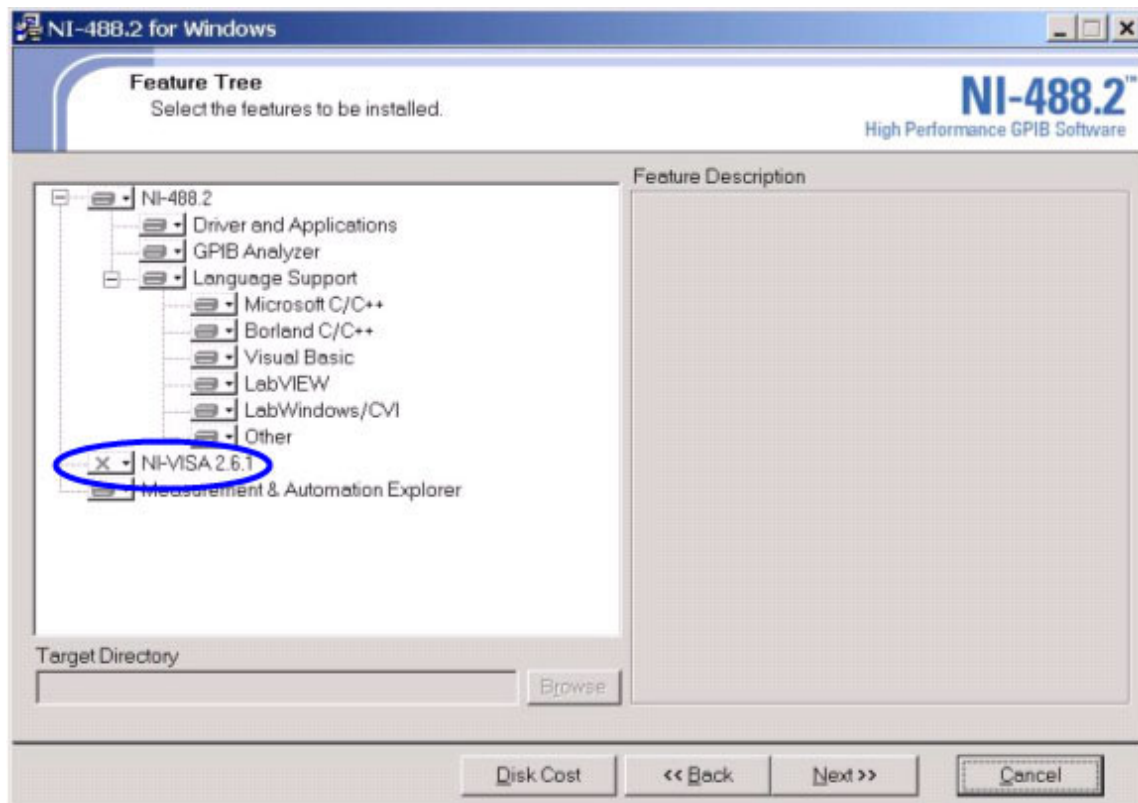

3. Install the Measurement & Automation Explorer software.
4. When prompted, enable the GPIB-USB interface.

NOTE. *If you already have NI-488.2 installed on your oscilloscope, then ensure that you have the appropriate version and installation parameters. Otherwise, remove NI-488.2, and then reinstall the appropriate version.*

5. Restart the oscilloscope.

NI-Software configuration for DPO70000 series

NOTE. *If you are using the NI-Drivers on the DPO70000 series for the first time perform steps 1 through 9. If not perform steps 7 through 9.*

1. In the oscilloscope menu, click **Utilities > GPIB Configuration**.

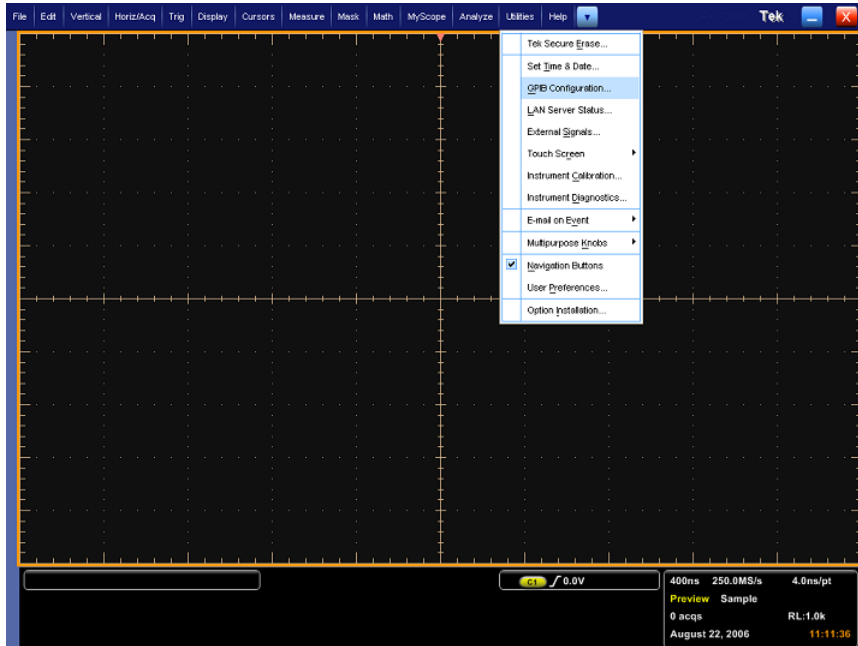

2. In the GPIB Configuration, select Controller. A GPIB Mode Switch dialog box is displayed.
3. Press **OK** to restart the oscilloscope.

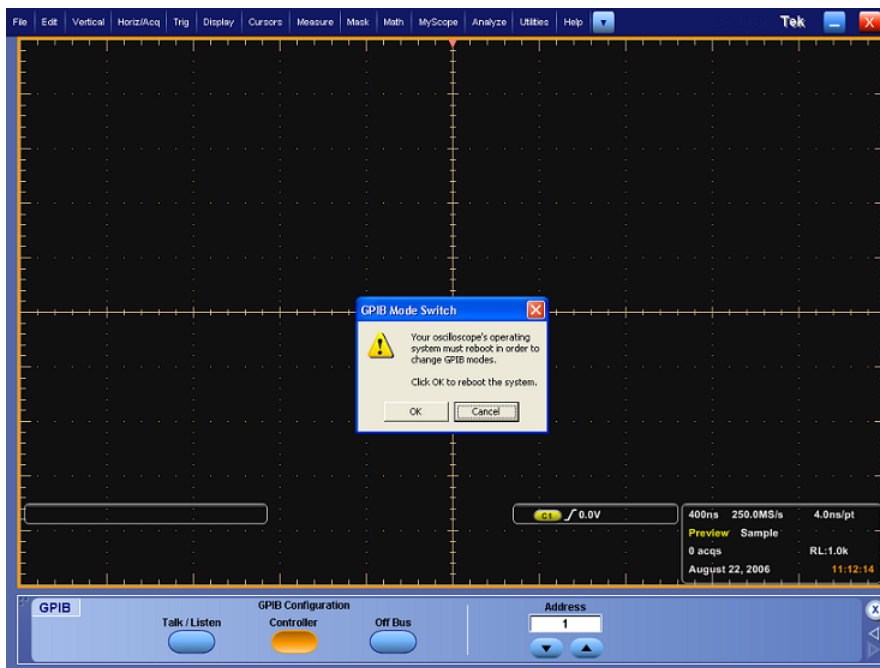

4. In the oscilloscope menu, click **Utilities > GPIB Configuration**.
5. In the GPIB Configuration, select **Talk/Listen**. A GPIB mode switch dialog box is displayed.

6. Press **OK** to restart the oscilloscope.

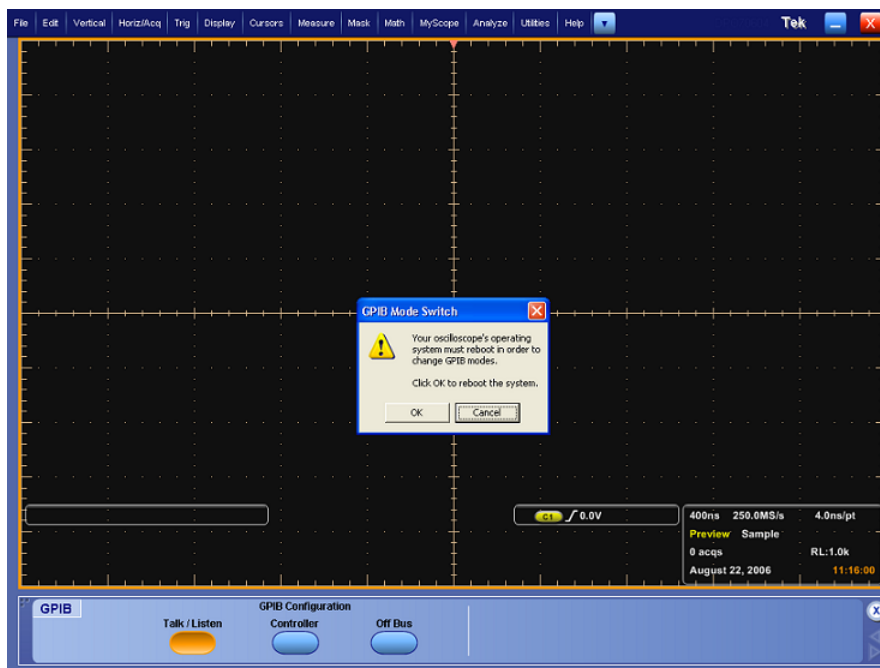

You cannot access the NI software from the **Start > Program** menu and will have to go to C:\Program Files\National Instruments\NI-488.2\Bin location.

7. Double-click **Add GPIB Hardware** to display the Add GPIB Hardware Wizard.

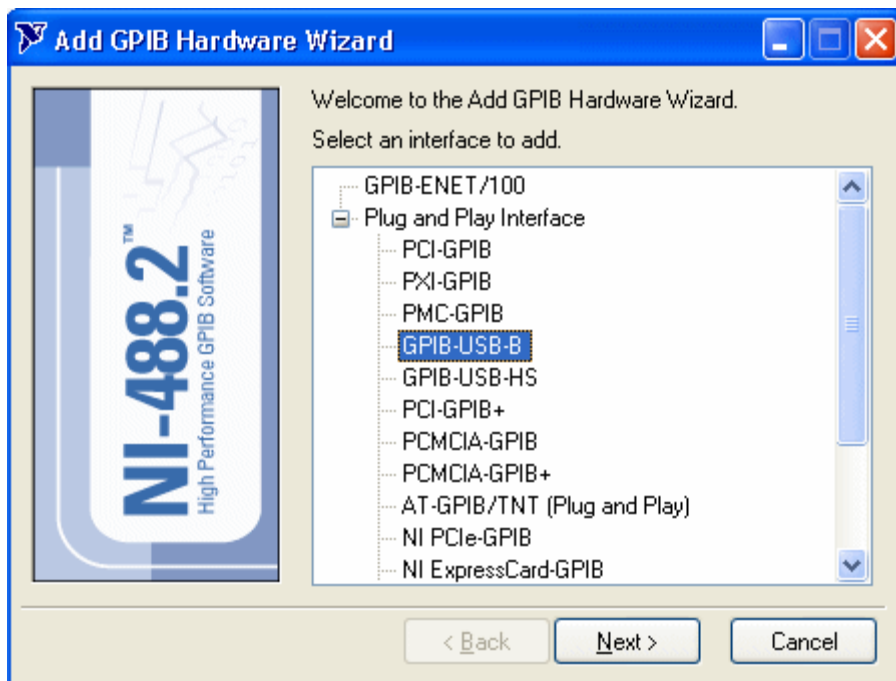

8. Select the appropriate NI hardware from the list (select GPIB-USB-B from the list if it is connected).
9. Press **Next** and finish the installation.

Configure and View Equipment Connections

This section helps you to configure the equipment and view the connections.

1. Configure the DTG GPIB primary address to 1 and AWG/AFG GPIB primary address to 2.
2. Connect the USB-GPIB controller to the USB port on the oscilloscope. The oscilloscope operating system will detect the USB-GPIB controller and install the appropriate driver for it.
3. Using GPIB cables, connect (stack) both the DTG and AWG/AFG GPIB ports to the GPIB port of the GPIB controller.

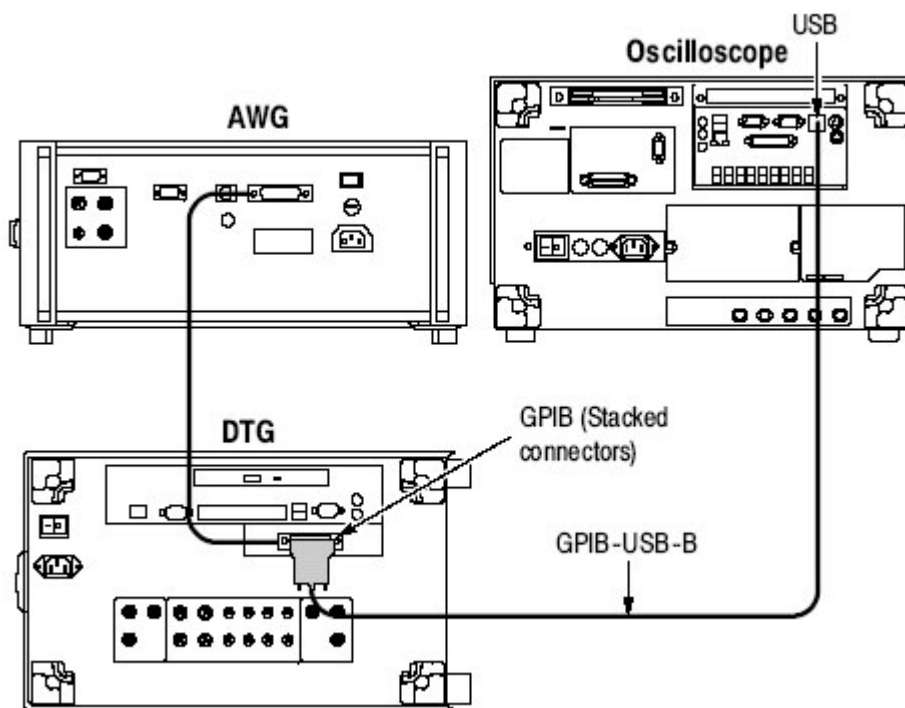

4. Open the Measurement & Automation Explorer software that was installed with the NI-488.2 software.

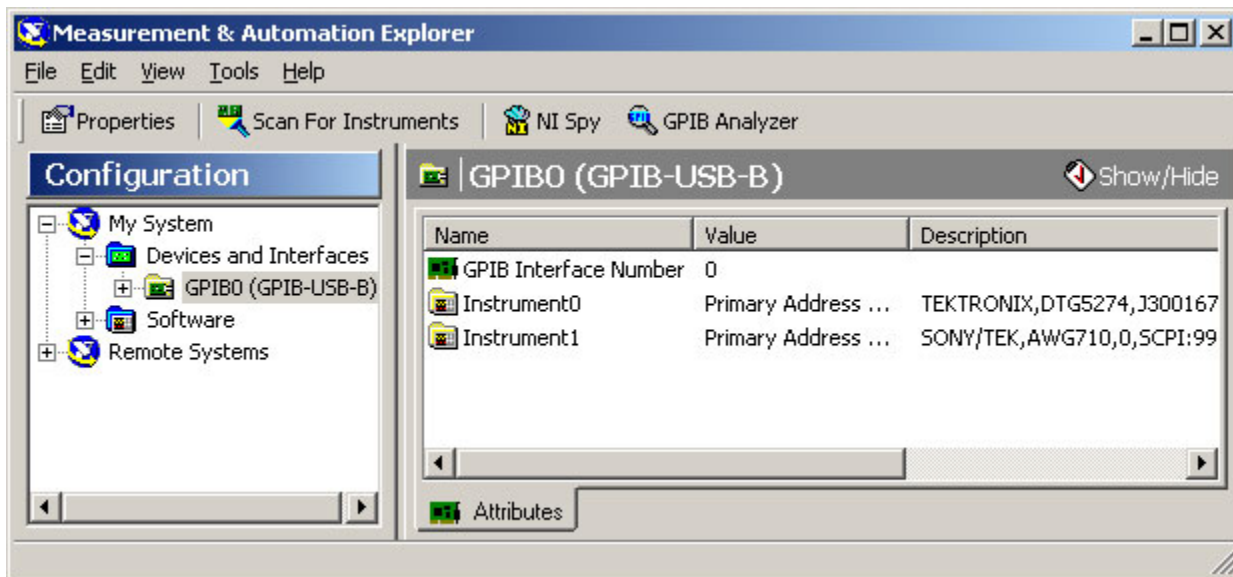

5. In the configuration pane, look under Devices and Interfaces for the GPIB device.
6. Right-click the GPIB device and click **Scan** for Instruments.
7. Note the GPIB Instrument Number and the Primary Address to configure the instrument connection in the TDSHT3 HDMI Compliance Test Software.
8. Right-click the instrument, and then click **Communicate** with Instrument.
9. In the NI-488.2 Communicator dialog box, click **Query** and check that “*IDN?” displays a description of the correct equipment.
10. Start the TDSHT3 HDMI Compliance Test Software.
11. Click **Select**.
12. Click the **Sink** tab.
13. Select one of the differential tests, such as Jitter Tolerance.

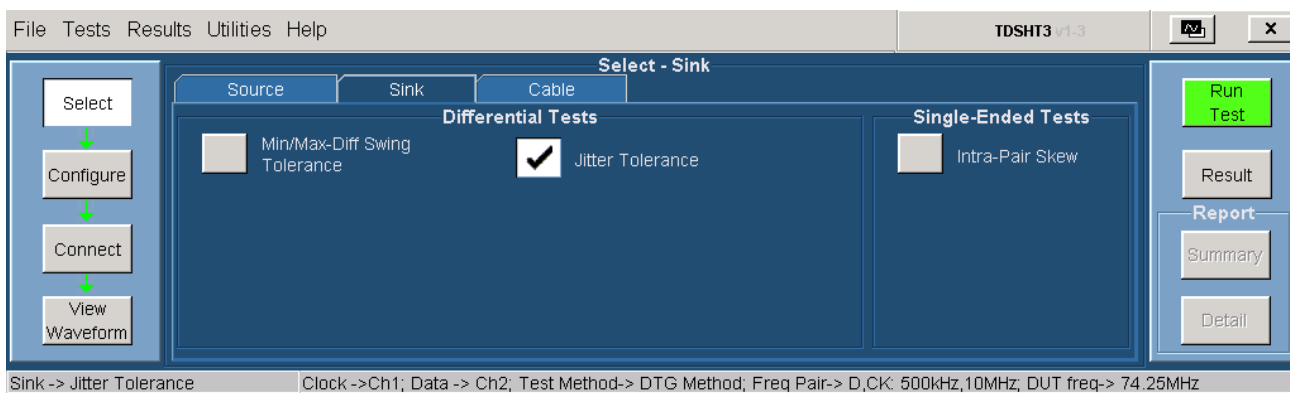

14. Click **Connect**.

15. Click **Signal Sources**. The Signal Sources Setup dialog box appears.

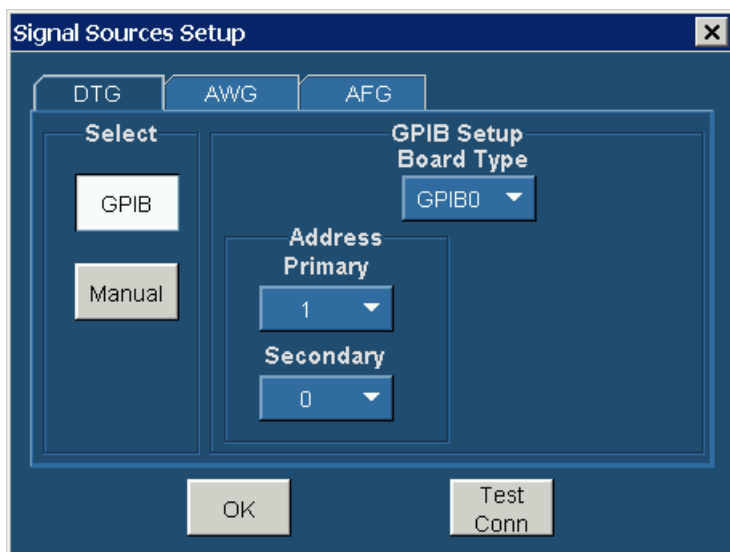

16. In the Signal Sources Setup dialog box, click the **DTG** tab.

17. Configure the GPIB Board Type by using the GPIB Instrument Number that you noted in step 4.

18. Configure the Primary Address by using the address that you noted in step 4.

19. Leave the Secondary Address set to 0.

20. Click **AWG** tab and repeat steps 14 through 16 for the AWG.

21. Click **AFG** tab and repeat steps 14 through 16 for the AFG.

22. Click **Test Conn** and look for a message that the connection is successful.

Configure New IP Address for GPIB-ENET

There are two methods to connect to AWG/DTG. One is the GPIB-USB method and the other, the GPIB-ENET method.

GPIB-ENET and GPIB-ENET/100 for Windows 3.1/95/98/ME/NT/2000/XP

1. Confirm that you have installed the latest NI-488.2 driver software for your device.
2. Connect your GPIB-ENET or GPIB-ENET/100 to an Ethernet network by using a category 5 Ethernet cable to connect the RJ-45 port on your hardware to an Ethernet hub. You could also connect the external hardware directly to your oscilloscope by using an Ethernet crossover cable.

3. Connect the power to your GPIB-ENET or GPIB-ENET/100 and turn it on. When you power on your GPIB-ENET, the POWER LED comes on immediately. The READY LED flashes while it completes its power-on self-test. When the test completes successfully and the IP address is assigned, the READY LED remains steady, indicating that the unit is ready to operate. To assign your IP address, continue to step 4.
4. Run the Measurement & Automation Explorer software from **Programs > National Instruments**.
5. Some devices are not Windows Plug and Play compatible. Hence, they do not automatically appear in the Devices and Interfaces list. Other devices may reside in another oscilloscope on your network. To add non Plug and Play or remote DAQ devices, right-click Devices and Interfaces in the configuration tree, and then click **Create New**. Follow the instructions in the wizard. Select GPIB-ENET/100 or GPIB-ENET interface according to the hardware.

How to Configure GPIB-ENET/100

1. To configure an existing National Instruments device, right-click the device name in Devices and Interfaces in the configuration tree, and then click **Properties**. You can also configure existing device properties by clicking **Properties** in the toolbar.
2. To configure the network parameters of your GPIB-ENET/100, right-click your GPIB interface in the configuration tree, and click **Device Configuration**.
3. Click **Properties**. Configure the IP address as shown in the following figure:

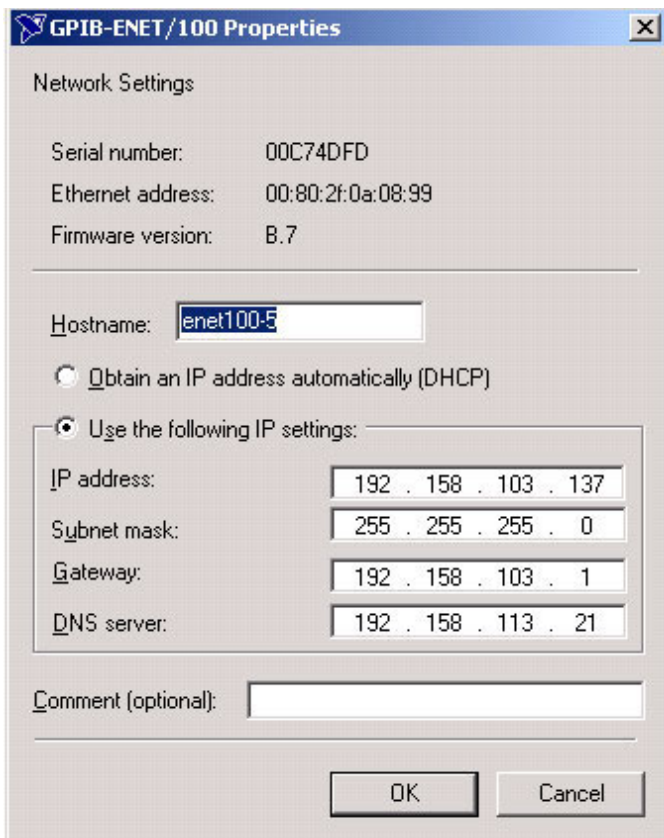

4. After entering the IP settings, click **OK**. A message box appears as follows:

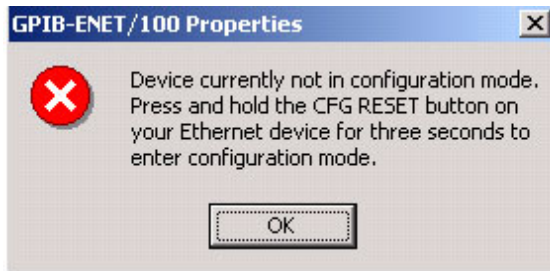

5. After you reset the CFG in the ENET card, click **OK** in the GPIB-ENET/100 Properties message box. The software will configure and another message box appears.

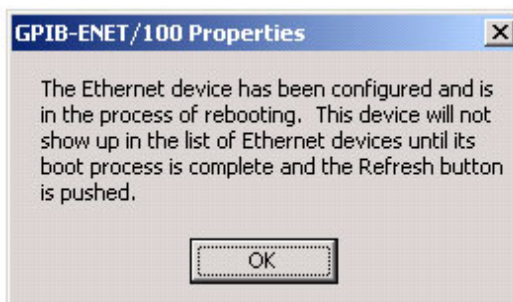

6. Click **OK**. The ENET card is configured.
7. Verify the configuration by pinging the IP address and through ICTA.

How to Configure GPIB-ENET (old card)

1. Right-click **Devices and Interfaces**. Click **Assign IP Address**. A message box appears.

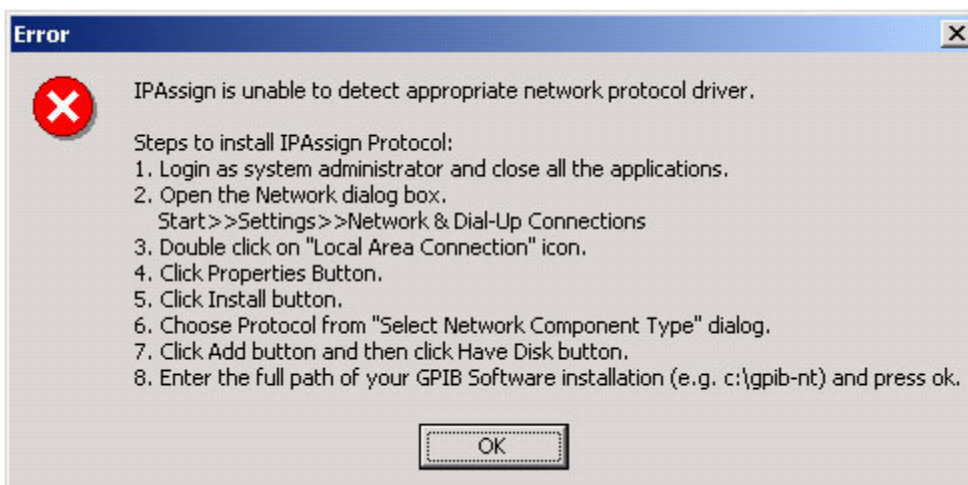

NOTE. The GPIB software installation is in the path *C:\Program Files\National Instruments\NI-488.2\GPIB-ENET on the oscilloscope.*

2. Run the Measurement & Automation Explorer software. Click **Assign IP Address**. A message box appears.

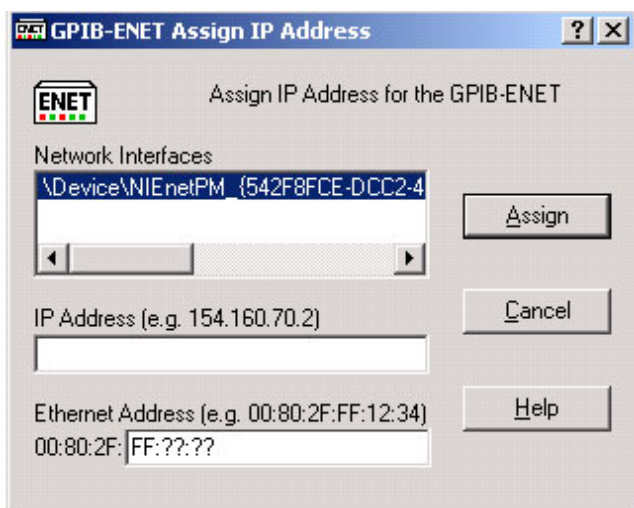

3. Enter the new IP Address and the Ethernet Address. Click **Assign**. A message box appears.

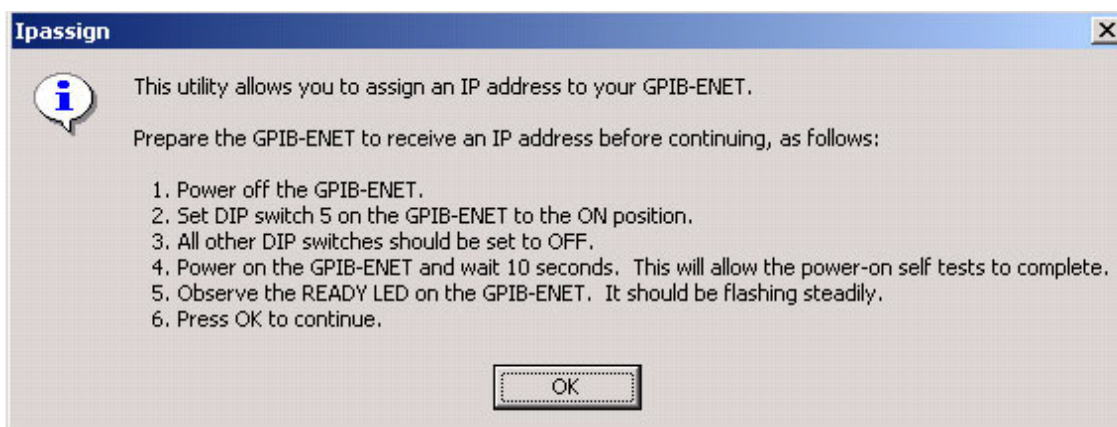

4. Follow the instructions in the Ipassign message box. Click **OK**. Another message box appears.

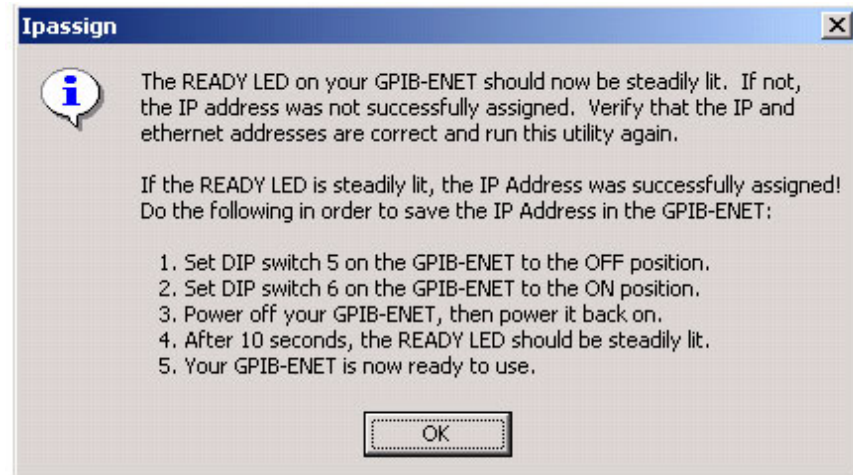

5. Follow the instructions in the new Ipassign message box. Click **OK**.

Remote Control Caution

If you run the Sink or Cable tests, the GPIB Bus Timing dialog box appears.



Click **OK** to continue if you are sure that the Bus Timing parameter is already set to 2 μ sec. Otherwise, click **Cancel** and follow the procedure outlined on later to change the Bus Timing parameter manually.

Once you have changed the parameter, select the check box if you do not want the dialog box to appear again in the current session. However, if you click **File > Recall Default** or you quit the software, then the dialog box appears again when you run the test.

When you install the remote control for the test equipment, the Measurement & Automation Explorer software will be installed on the oscilloscope. You can start the software by clicking **Start > Program Files > National Instruments > Measurement & Automation**.

To change the Bus Timing parameter, perform the following steps:

1. Start the Measurement & Automation Explorer software.
2. In the configuration pane, look under Devices and Interfaces for the GPIB device.
3. Right-click the GPIB device and click **Properties**. The GPIB Configuration dialog box appears.
4. In the GPIB Configuration dialog box, click the **Advanced** tab.
5. In the Bus Timing list, select 2 μ sec.

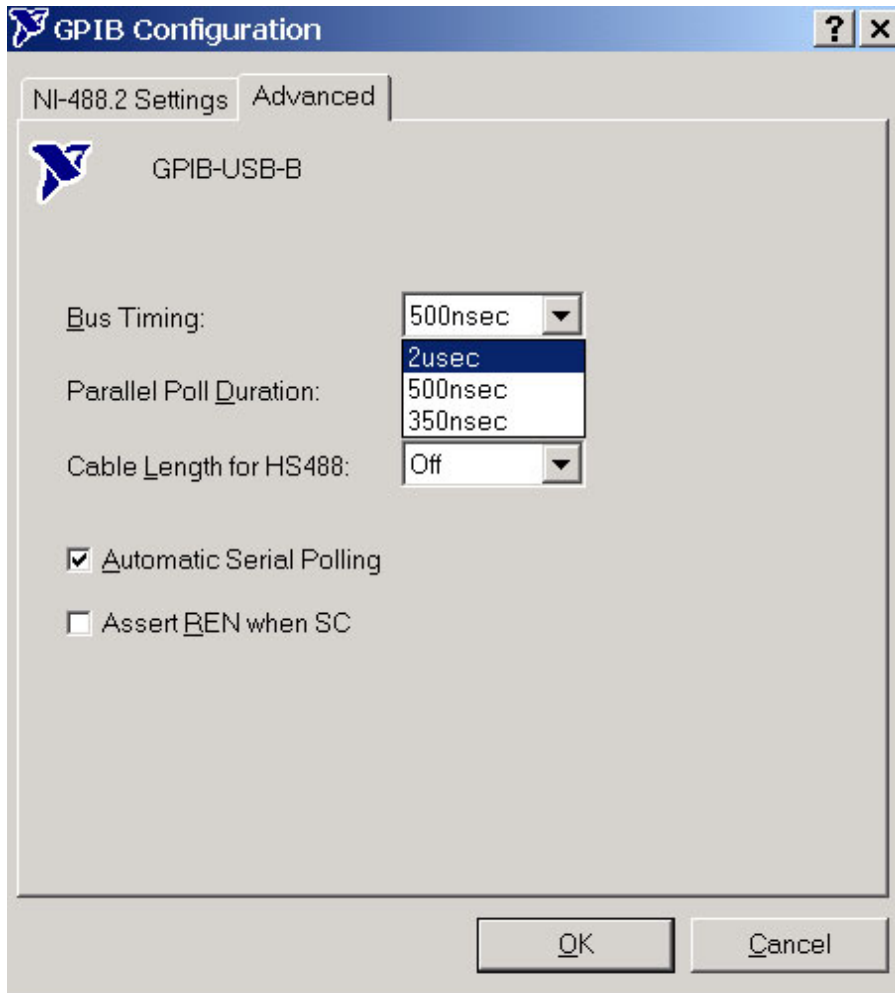

6. Quit the TDSHT3 HDMI Compliance Test Software and restart the oscilloscope.

Remote GPIB Commands

The Remote General Purpose Interface Bus (RGPIB) is essentially another way of interfacing with the oscilloscope. It allows you to control much of the functionality of the oscilloscope as defined by the software, from a Remote GPIB controller.

You can use the following GPIB command to start the TDSHT3 HDMI Compliance Test Software:

```
application:activate "HDMI Compliance Test Software(1.3)"
```

How to Set and Query

1. The following command syntax sets the value to the variable:

```
VARIABLE:VALUE "<variable name>","<variable value>"
```

The arguments <variable name> and <variable value> are required in the order indicated.

2. The following command syntax queries the value of the variable:

```
VARIABLE:VALUE? "<variable name>"
```

3. The following command syntax runs the selected test:

```
VARIABLE:VALUE "sequencerState", "Sequencing"
```

The TDSHT3 HDMI Compliance Test Software will be remotely controllable for the following set of commands for (VARIABLE:VALUE):

Application

Variable name	Valid values	Function (Set)	Query form
Application	exit	Set the value to quit a running the software.	Query to return the name of the currently running software.
version	-	-	Query to return the version of the currently running software, for example, Version: 1.0.0.

Sequencer

Variable name	Valid values	Function (Set)	Query form
sequencerState	{ Sequencing}: to set {Ready, Sequencing}: returned on query	Set the sequencer state.	Return the sequencer state.

Save/Recall

Variable name	Valid values	Function (Set)	Query form
setup	{Default, Recall, Save}	Set the Save/Recall/Default action.	Default value for this variable is an empty string. Thus, the variable is set to selected value momentarily and after the task is completed, it returns to its default value.
recallName	Any string 1-8 chars, comprised of A-Z , 0-9	Set the setup recall file name.	Return the setup recall file name.
saveName	Any string 1-8 chars, comprised of A-Z , 0-9	Set the setup save file name.	Return the setup save file name.

Report

Variable name	Valid values	Function (Set)	Query form
reportSummary	Save	Save the report summary to a .csv file.	-
reportDetail	Save	Save the report details to a .mht file.	-

Result Details

After the test is complete, on the result pane, click **Result Details** to display the details of the result.

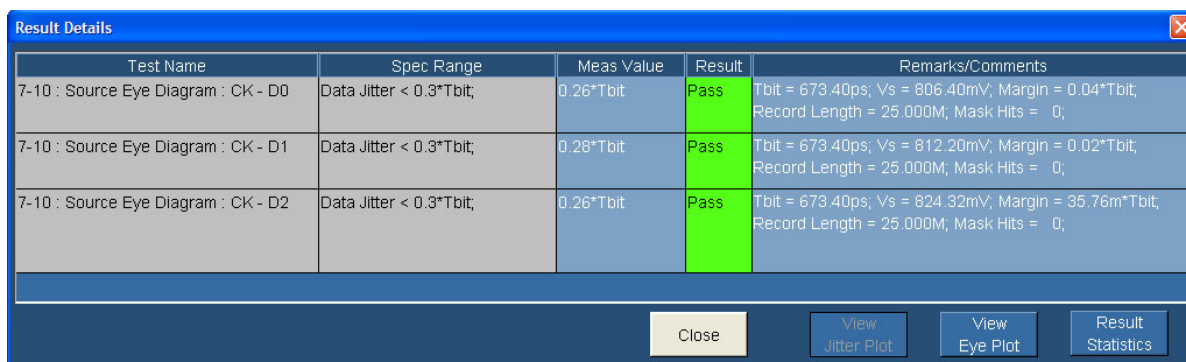

Options	Description
Test Name	The Test Name column displays the test id, test name, and selected lanes.
Spec Range	The Spec Range column describes the HDMI standards and test specifications limit for the test.
Meas Value	The Meas Value column displays the measured value.

Options	Description
Result	The Result column displays the status of the test as Pass, Fail, or Error.
Remarks/Comments	The Remarks/Comments column displays the results of Tbit, Vswing, and Margin. If the test could not be run, then an error code appears.
Close	Click Close to quit the Result Details dialog box.
View Jitter Plot	Click View Jitter Plot to display the jitter plot. This option is available if you have successfully run the clock jitter test.
View Eye Plot	Click View Eye Plot to display the eye plot. This option is available if you have successfully run the eye diagram test.
Result Statistics	Click Result Statistics to display statistics based on the tests.

NOTE. The parameters in the Result Details dialog box may change depending on the test that you run.

Virtual Keyboard

Virtual Keyboard - Numeric

1. Click any number box to display the icon for the numeric keyboard.

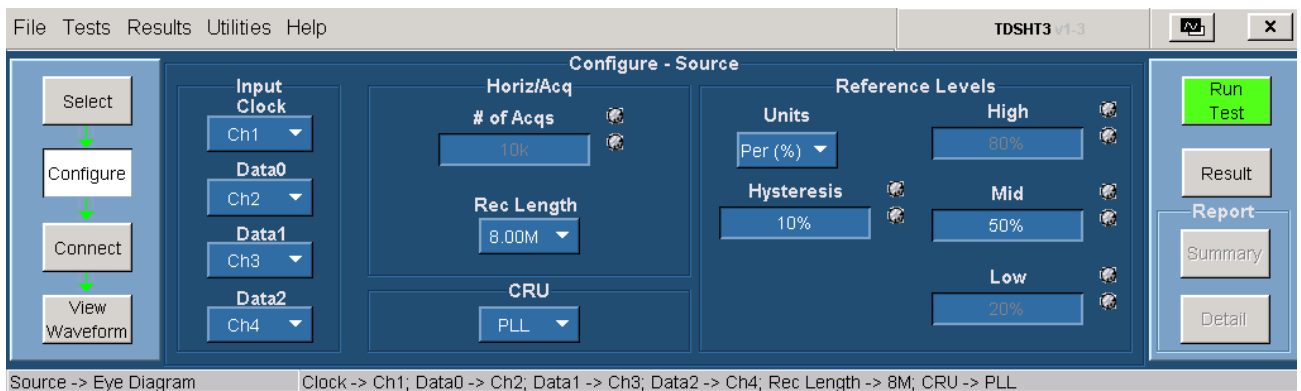

2. Click the icon to display the numeric keyboard.



3. Click the number keys to enter the desired value.
4. Select a unit of measure.
5. Click **Enter** to confirm your entry. Selections are not effective until you click **Enter**.

Virtual Keyboard - Text

1. Click **New** to display the virtual keyboard.

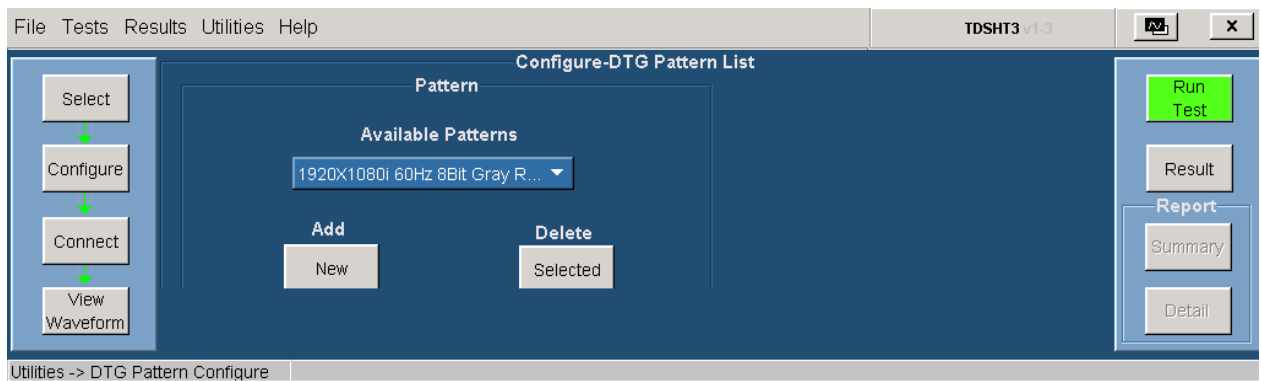

2. Use the text keyboard to enter the required text (such as a file name).



3. Click **Enter** to confirm your entry. Selections are not effective until you click **Enter**.

Exit

To quit the software:

1. On the menu bar, click **File > Exit**.
2. The Exit dialog box appears.

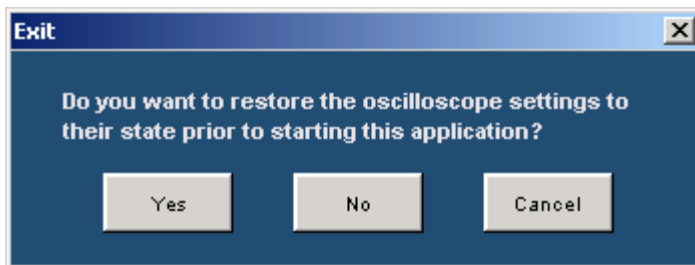

3. Click either **Yes**, **No**, or **Cancel**. Yes is selected by default. While the software is running, it automatically changes some oscilloscope settings. When you quit the software, you can choose whether to retain these settings or restore the previous settings.

NOTE. Using other methods to quit the software may result in an abnormal termination of the software.

Calculate Tbit

On the Menu bar, click **Test > Configure** after the measurement is selected from the Select screen.

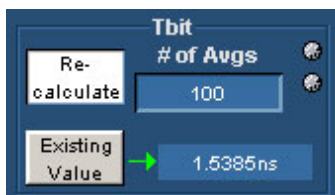

Tbit is the time that is required to transmit one bit of data. Tbit is one bit time at the specified pixel clock frequency ($= T_{\text{PIXEL}}/10$).

For all the tests that require clock, the software calculates Tbit. For all the other tests, you have an option of either recalculating Tbit or use the previous Tbit value for the test.

If you click **Re-calculate**, the software computes the specified number of averages of T_{PIXEL} and then calculates Tbit. If you use the existing Tbit value, then the software uses the previously calculated Tbit value or you can again recalculate Tbit by using the Tbit pane.

To calculate Tbit for a test, use the Tbit pane. You can calculate Tbit for Rise Time, Fall Time, Inter-Pair Skew, Source Intra-Pair Skew, Low Amplitude +, Low Amplitude -, and Sink Intra-Pair Skew test if the clock is not connected.

To Calculate Tbit

1. Set up the connections as shown in the following diagram:

Setup 1: Connections to calculate Tbit

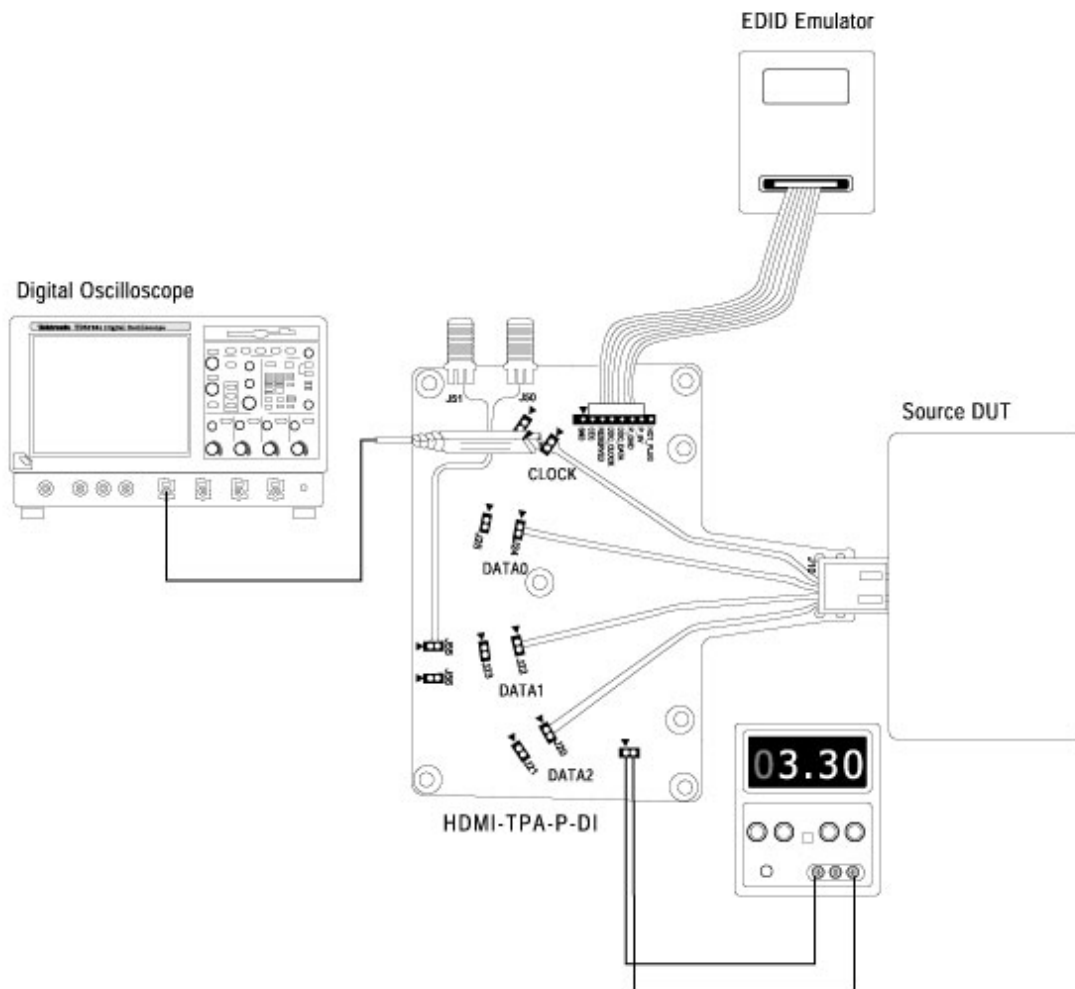

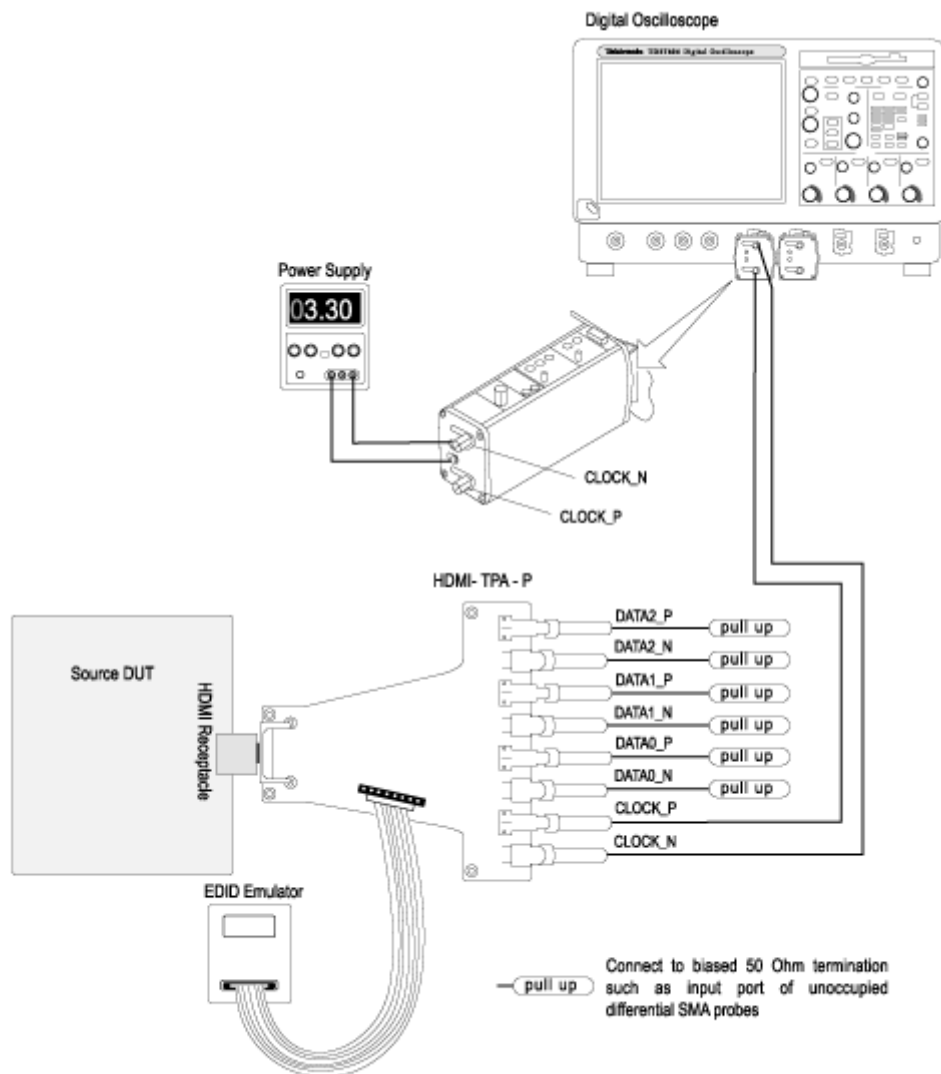
Setup 2: Connections to calculate Tbit with Efficere Test Fixture

- Connect an TPA-P-DI adapter to a Source DUT HDMI output connector.
 - Connect a power supply to a TPA board.
 - Configure the Source DUT to output a video format with the required supported pixel clock frequency.
 - Connect a TMDS Clock to the configured oscilloscope channel by using a differential probe.
2. In the Tbit pane, you have the following options:

Configure parameter	Description
# of Avgs	In the # of Avgs box, enter the desired number of periods that are considered to calculate Tbit. The default value is 100.
Re-calculate	Click Re-calculate to recalculate the Tbit value.
Existing Value	Click Existing Value to use the previously calculated Tbit value.

NOTE. Tbit value is used for oscilloscope setup and limit calculations. If the DUT's display resolution and the refresh rate changes, you have to recalculate Tbit.

Deskew

Deskew is recommended before you conduct any skew test. To ensure accurate results, deskew the test setup before you conduct the tests from your device under test.

1. On the menu bar, click **Utilities > Deskew**.

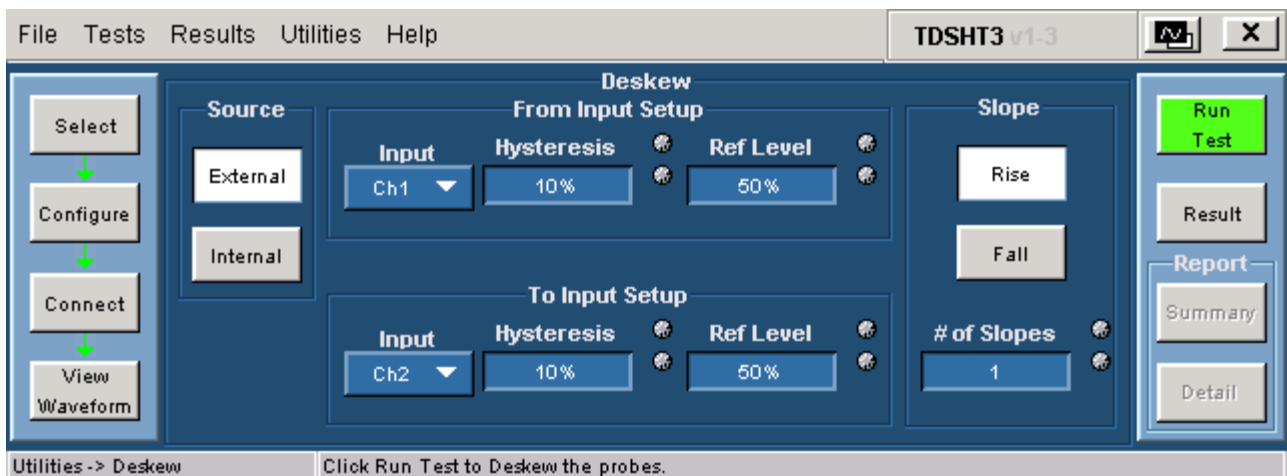

2. In the source pane, you have the following options:

Configure parameter	Description
External	Click External if you will use an external signal source (such as the clock signal of DUT).
Internal	Click Internal to probe the compensation signal on an oscilloscope.

3. Select the input channels between which you want to perform the deskew operation. Hysteresis and Ref Level are available only for an external source.

4. In the slope pane, you have the following options:

Configure parameter	Description
Rise	Click Rise to calculate the average of the number of slopes and then set the skew for a rising pulse.
Fall	Click Fall to calculate the average of the number of slopes and then set the skew for a falling pulse. You do not have to calculate the average of the number of slopes for a falling pulse for an internal source.
# of Slopes	In the # of Slopes box, enter the required number of slopes to enable to set the skew for either a rising pulse or a falling pulse. Ensure that the required number of slopes is present in the acquisition.

5. Set up the oscilloscope as follows:

- Set the acquisition rate so that there are two or more samples on the deskew edge using the horizontal scale knob.
- Adjust the signals and display them on the screen using the vertical scale and position knobs.
- Set the record length so that there are more samples for the edges in the acquisition.

6. Click **Run Test** to deskew the probes.

Configure-DTG Pattern List

1. On the menu bar, click **Utilities > DTG Pattern List**.

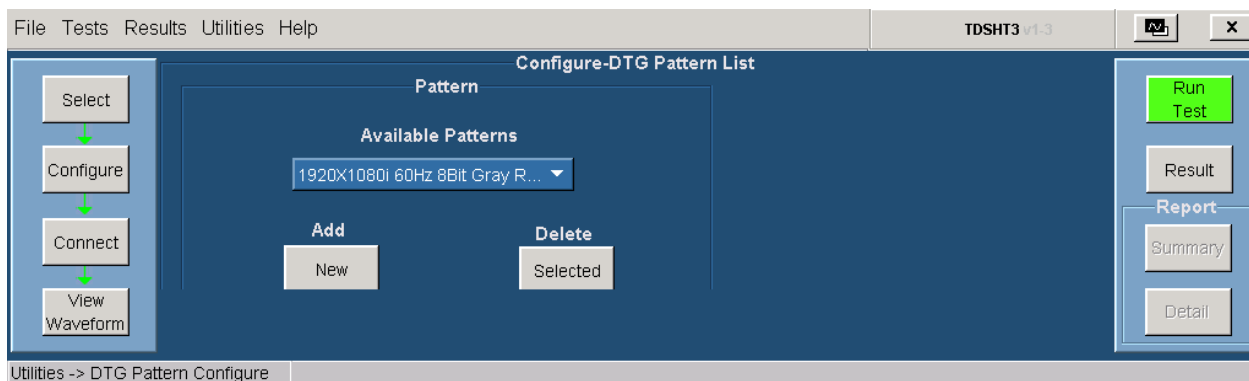

2. In the Pattern pane, the Available Patterns drop-down list displays all the available patterns (including the newly added ones). The DTG pattern selected from the Configure screen is displayed as the default pattern in the Available Patterns list.

3. Click **New** to add a new DTG pattern. Type the name of the pattern and click **Enter** to save the pattern. All the newly added patterns will be available in Cable Eye Diagram, Sink Min/Max Diff, and Sink Jitter Tolerance measurements. The newly added pattern files should have a **.dtg** extension.



4. You can delete an added pattern by selecting the pattern from the Available Patterns list. Click **Selected** to delete the selected pattern. The default patterns installed by the application cannot be deleted.

NOTE. All the folders of the application should have unique DTG pattern names.

Source

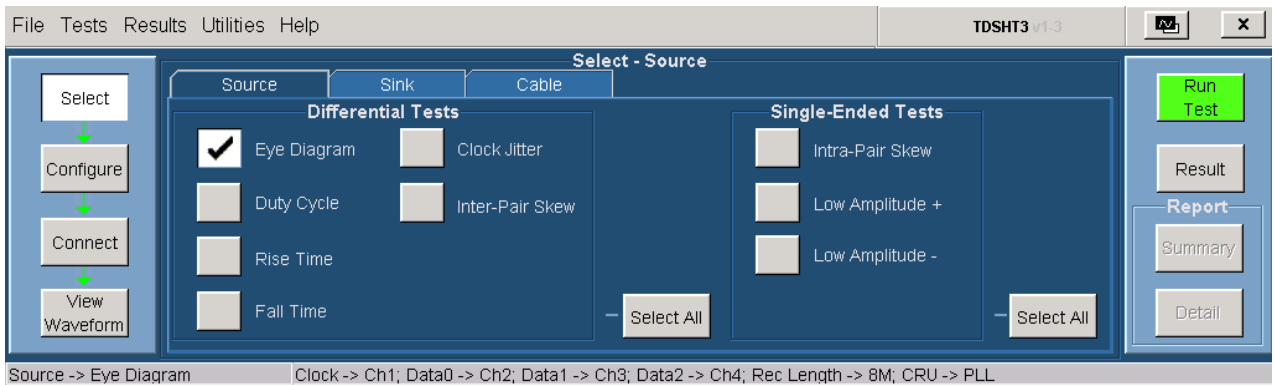

The following table shows how to select the source test parameters:

Test type	How to select
Source	Click Tests > Select > Source to select the source tab.
Differential Tests	
Eye Diagram	In the Source tab, select the Eye Diagram check box.
Duty Cycle	In the Source tab, select the Duty Cycle check box.
Rise Time	In the Source tab, select the Rise Time check box.

Test type	How to select
Fall Time	In the Source tab, select the Fall Time check box.
Clock Jitter	In the Source tab, select the Clock Jitter check box.
Inter-Pair Skew	In the Source tab, select the Inter-Pair Skew check box.
Select All	In the Source tab, click Select All to select multiple tests for Differential Tests. When you select more than one test, Select All changes to Clear All.
Single-Ended Tests	
Intra-Pair Skew	In the Source tab, select the Intra-Pair Skew check box.
Low Amplitude +	In the Source tab, select the Low Amplitude + check box.
Low Amplitude –	In the Source tab, select the Low Amplitude – check box.
Select All	In the Source tab, click Select All to select multiple tests for Single-Ended Tests. When you select more than one test, Select All changes to Clear All.

Sink

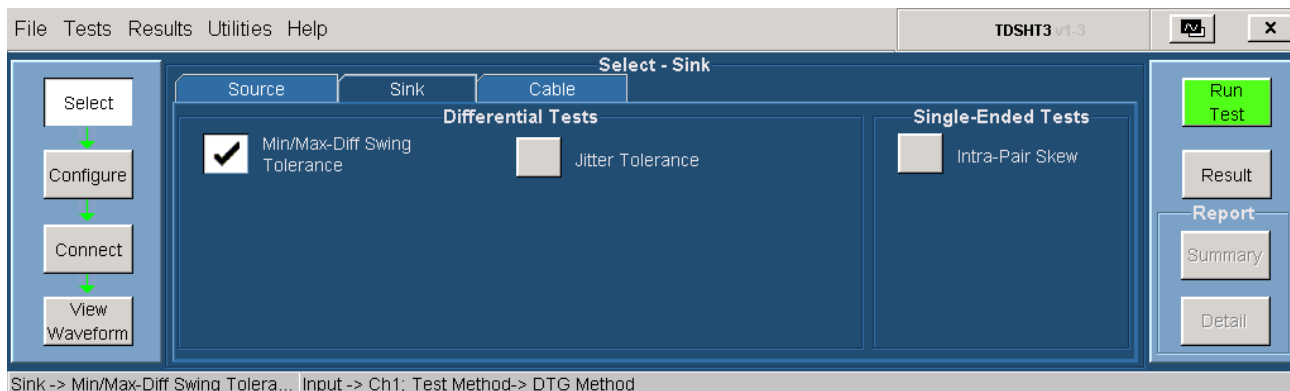

The following table shows how to select the sink test parameters:

Test type	How to select
Sink	Click Tests > Select > Sink to select the sink tab.
Differential Tests	
Min/ Max-Diff Swing Tolerance	In the Sink tab, select the Min/ Max-Diff Swing Tolerance check box.
Jitter Tolerance	In the Sink tab, select the Jitter Tolerance check box.
Single-Ended Tests	
Intra-Pair Skew	In the Sink tab, select the Intra-Pair Skew check box.

Cable

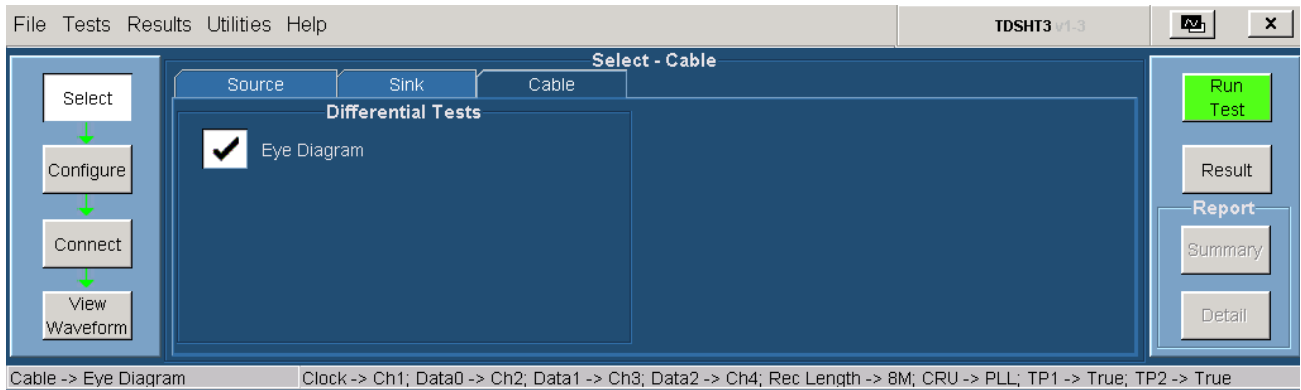

The following table shows how to select the cable test parameters:

Test type	How to select
Cable	Click Tests > Select > Cable to select the cable tab.
Eye Diagram	In the Cable tab, select the Eye Diagram check box.

Source

On the menu bar, click **Tests > Configure** to configure the parameters for the selected test(s).

In the configure pane, you will see the factory default configuration for the test you selected. For most tests, you can use the factory default configuration. However, you can change the values by using the [virtual keyboard](#) or the [general purpose knob](#) on the oscilloscope front panel. Using the File menu, you can also restore the factory defaults or save and recall your own configuration settings. It is recommended that you save the configuration settings before you choose to select Recall Default or close the application. For more information about configuration, refer to How to... Test and go to a specific test.

The following table shows the parameters that you can configure for source (differential tests):

			Source Input	Clock	Hysteresis	Mid Ref Level	Low Ref Level	High Ref Level	Record Length	Tbit	# of Acqs	Units	CRU
Source													
	Differential												
		Eye Diagram	Clock, Data0, Data1, and Data2	Yes	Yes	Yes			Yes			Yes	Yes
		Duty Cycle	Clock							Yes	Yes		
		Rise Time	Clock, Data0, Data1, and Data2				Yes	Yes		Yes	Yes	Yes	
		Fall Time	Clock, Data0, Data1, and Data2				Yes	Yes		Yes	Yes	Yes	
		Clock Jitter	Clock	Yes	Yes	Yes			Yes			Yes	Yes
		Inter-Pair Skew	Clock, Data0, Data1, and Data2	Yes	Yes	Yes				Yes		Yes	

The following table shows the parameters that you can configure for source (single-ended tests):

			Source Input	AVCC	Tbit	# of Acqs
Source						
	Single-Ended					
		Intra-Pair Skew	Clock+ and Clock-Data0/Data1/Data2+ and Data0/Data1/Data2-		Yes	Yes
		Low Amplitude +	Clock+ and Clock-Data0/Data1/Data2+ and Data0/Data1/Data2-	Yes	Yes	Yes
		Low Amplitude -	Clock+ and Clock-Data0/Data1/Data2+ and Data0/Data1/Data2-	Yes	Yes	Yes

Sink

On the menu bar, click **Tests > Configure** to configure the parameters for the selected test.

In the configure pane, you will see the factory default configuration for the test you selected. For most tests, you can use the factory default configuration. However, you can change the values by using the [virtual keyboard](#) or the [general purpose knob](#) on the oscilloscope front panel. Using the File menu, you can also restore the factory defaults or save and recall your own configuration settings. It is recommended that you save the configuration settings before you choose to select Recall Default or close the application. For more information about configuration, refer to How to... Test and go to a specific test.

The following table shows the parameters that you can configure for sink (differential tests):

			Source Input	Clock	DTG Pattern Path	DTG Output	Frequency Pair	DUT Freq (MHz)	Jitter Insertion Type	Jitter Amplitude
Sink										
	Differential									
		Min/Max-Diff Swing Tolerance	Clock/Data		Yes	Yes				
		Jitter Tolerance	Clock and Data	Yes	Yes	Yes	Yes	Yes	Yes	Yes

The following table shows the parameters that you can configure for sink (single-ended tests):

			Source Input	Tbit	DTG Pattern Path	DTG Output	Skew on all Channels
Sink							
	Single-Ended						
		Intra-Pair Skew	Clock	Yes	Yes	Yes	Yes

Cable

On the menu bar, click **Tests > Configure** to configure the parameters for the selected test.

In the configure pane, you will see the factory default configuration for the test you selected. For most tests, you can use the factory default configuration. However, you can change the values by using the [virtual keyboard](#) or the [general purpose knob](#) on the oscilloscope front panel. Using the File menu, you can also restore the factory defaults or save and recall your own configuration settings. It is recommended that you save the configuration settings before you choose to select Recall Default or close the application. For more information about configuration, click the How to...Test help topic, and then go to the specific test.

The following table shows the parameters that you can configure for cable (differential tests):

			Source Input	Clock	Hysteresis	Mid Ref Level	Record Length	Units	TP1-TP2	DTG Pattern Path	DTG Output	Cable Equalizer	Rise Time Filter	CRU	Jitter Insertion
Cable															
	Differential														
		Eye Diagram	Clock, Data0, Data1, and Data2	Yes	Yes	Yes	Yes	Yes	Yes	Yes	Yes	Yes	Yes	Yes	Yes

EDID Emulator for Source Tests

The EDID-PCB or EDID Emulator can be used in the following Source connection diagrams.

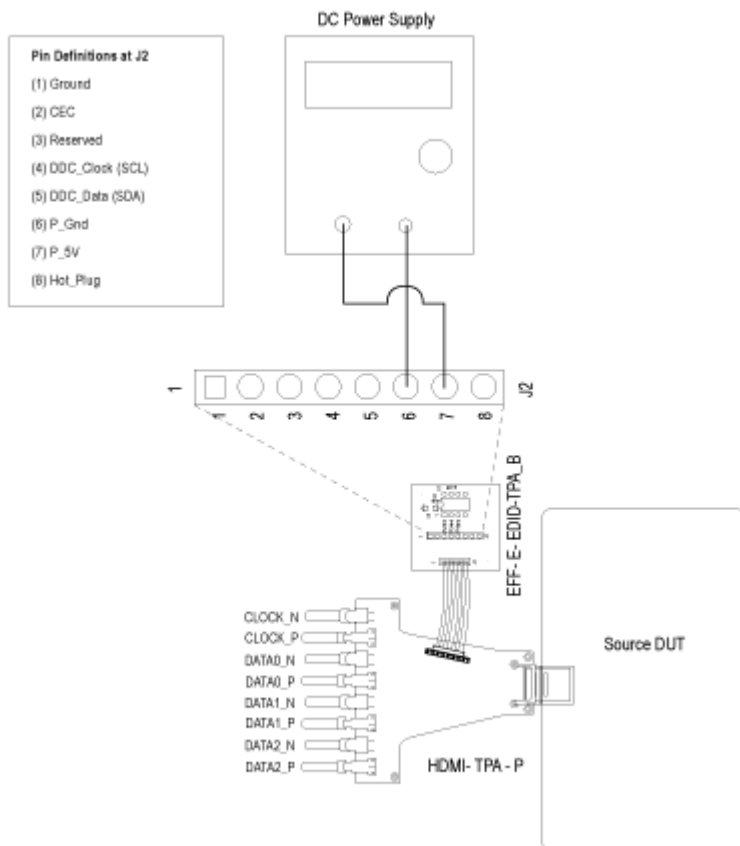

Eye Diagram (Source)

On the menu bar, click **Tests > Connect** and make the connection as follows. Refer to [EDID Emulator for Source Tests](#) for EDID emulator connections.

Method 1: Connections for Source Eye Diagram

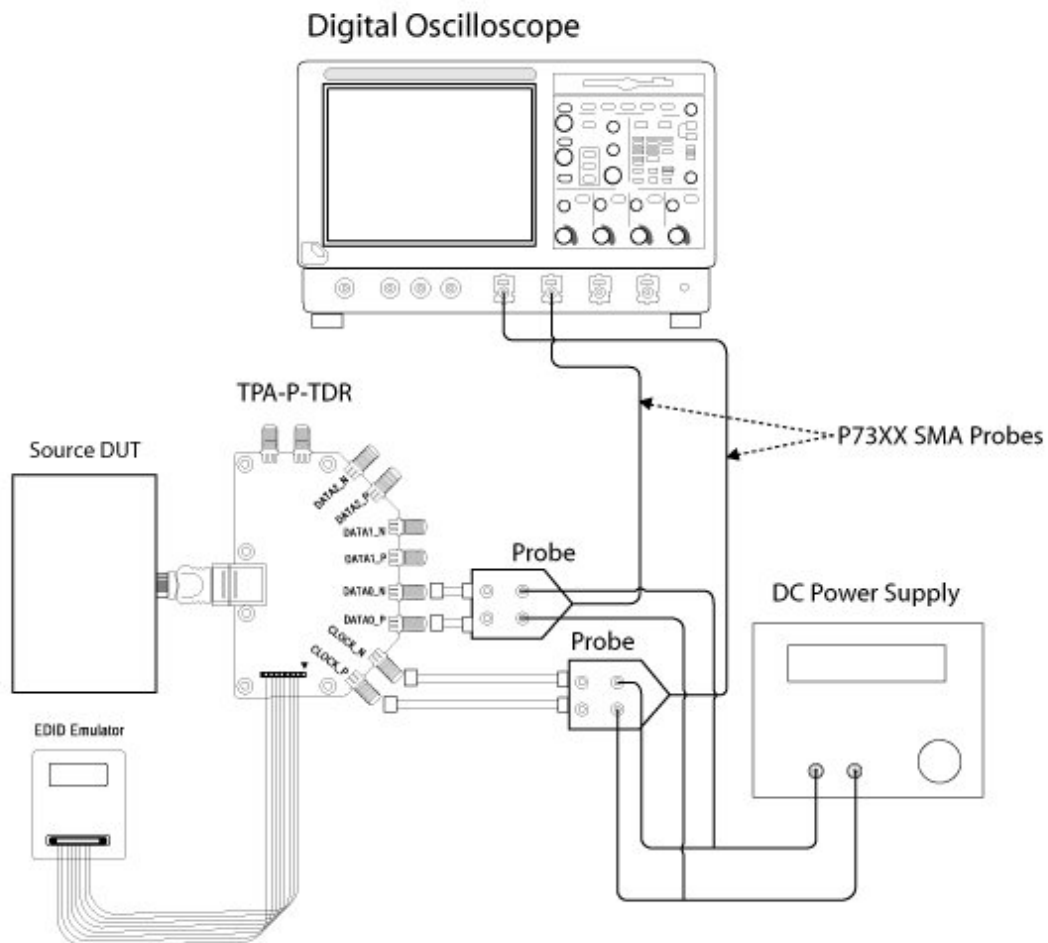

Method 2: Connections for Source Eye Diagram with Efficere Test Fixture

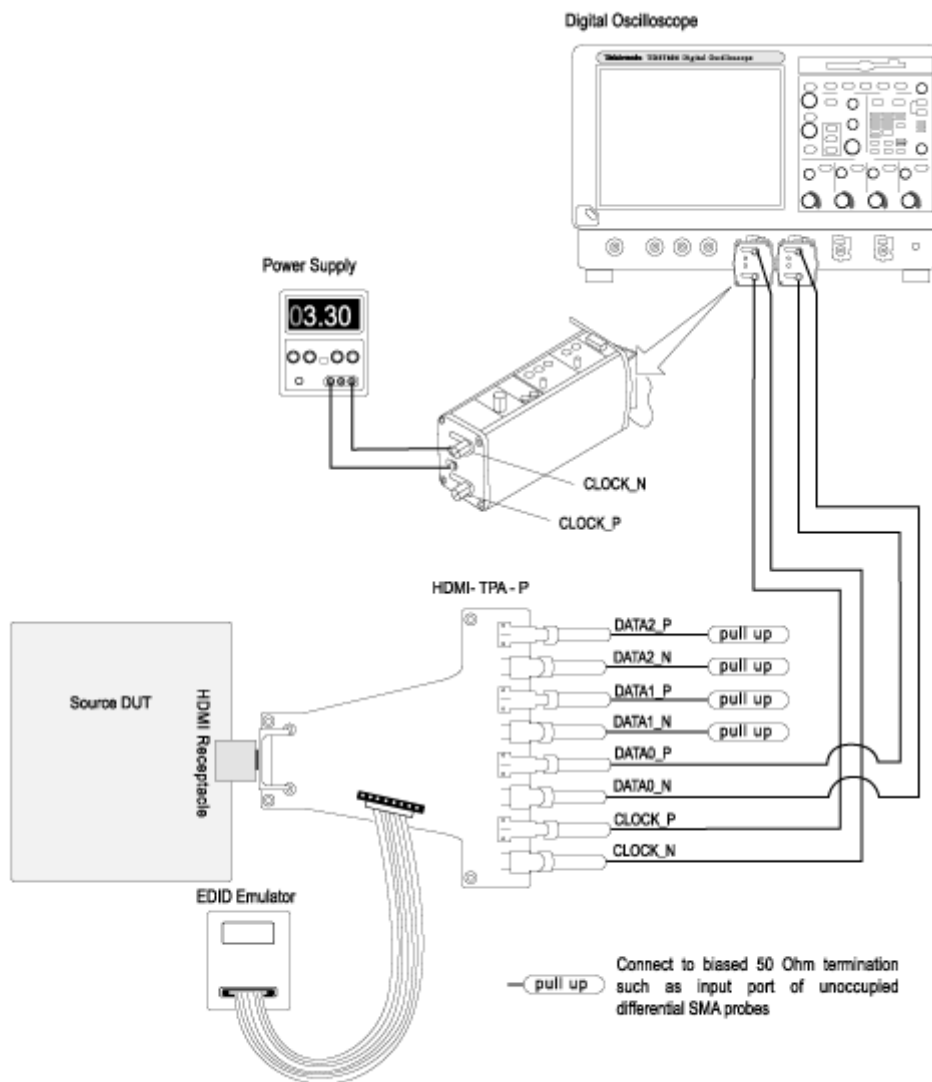

For 4-Channel

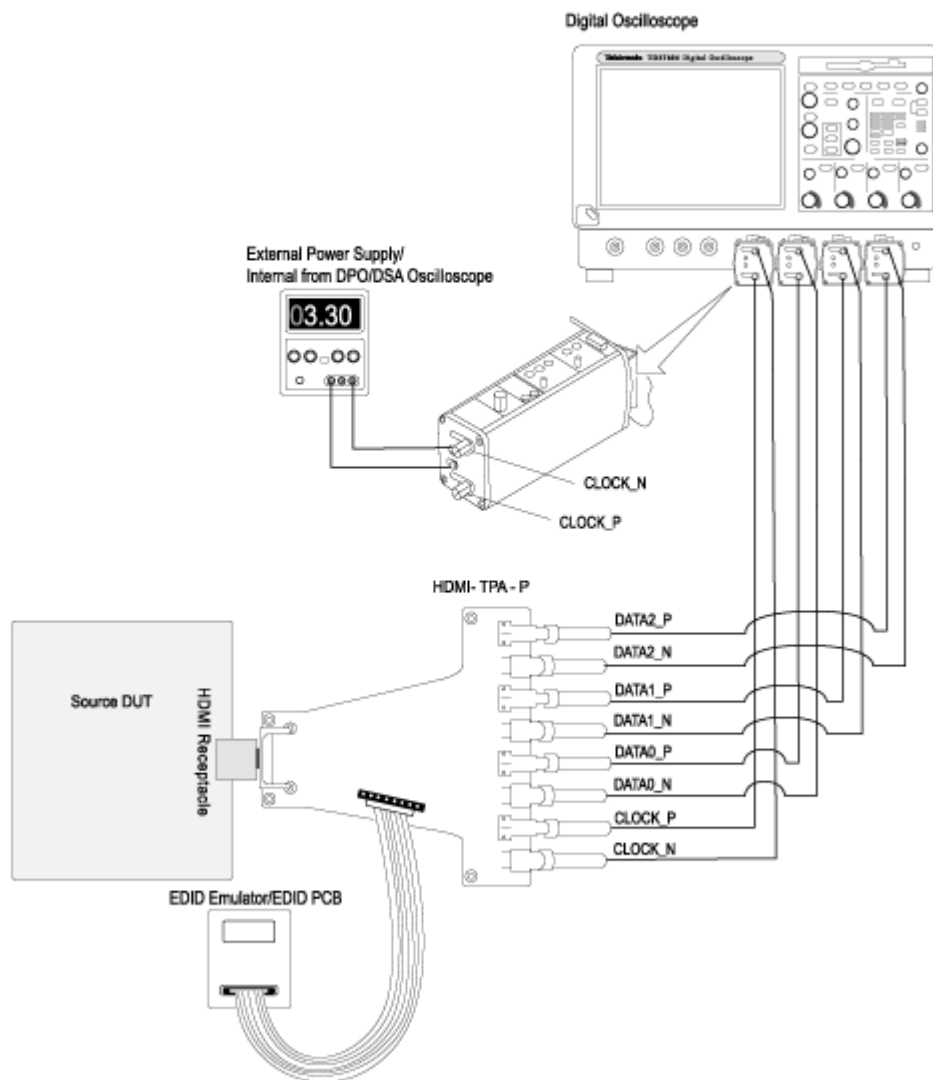

1. Connect the HDMI output of the source DUT to the TPA-P-TDR/ ET-TPA-P adapter.
2. Connect a power supply to the TPA adapter and set the power supply to 3.30 V.

NOTE. For the DPO/DSA70000 series oscilloscopes with P7313 SMA probes and Efficere fixtures, you have the option to set the probe control voltage to **internal** from the [Preferences](#) menu. If this option is selected, an external power supply is not required.

3. Connect the EDID emulator to the TPA adapter and set the emulator for the required resolution (refer to the EDID emulator user manual).
4. Connect a TMDS Clock to the configured oscilloscope channel by using a SMA differential probe.
5. Connect the TMDS_DATA pair(s) on which you will conduct the test to the configured oscilloscope channel by using a SMA differential probe.
6. Configure the Source DUT to output the required video format.

Duty Cycle

On the menu bar, click **Tests > Connect** and make the connection as follows. Refer to [EDID Emulator for Source Tests](#) for EDID emulator connections.

Method 1: Connections for Source Duty Cycle

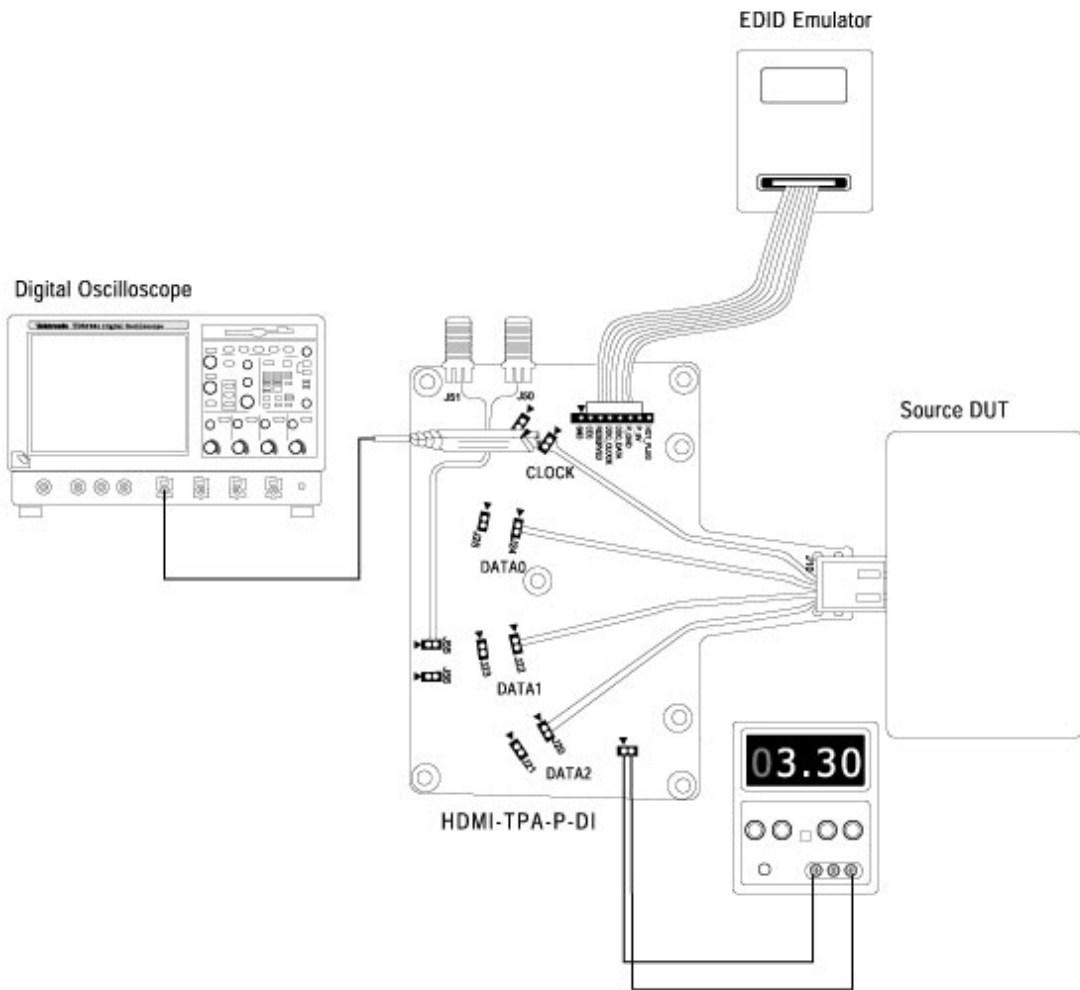

Method 2: Connections for Source Duty Cycle with Efficere Test Fixture

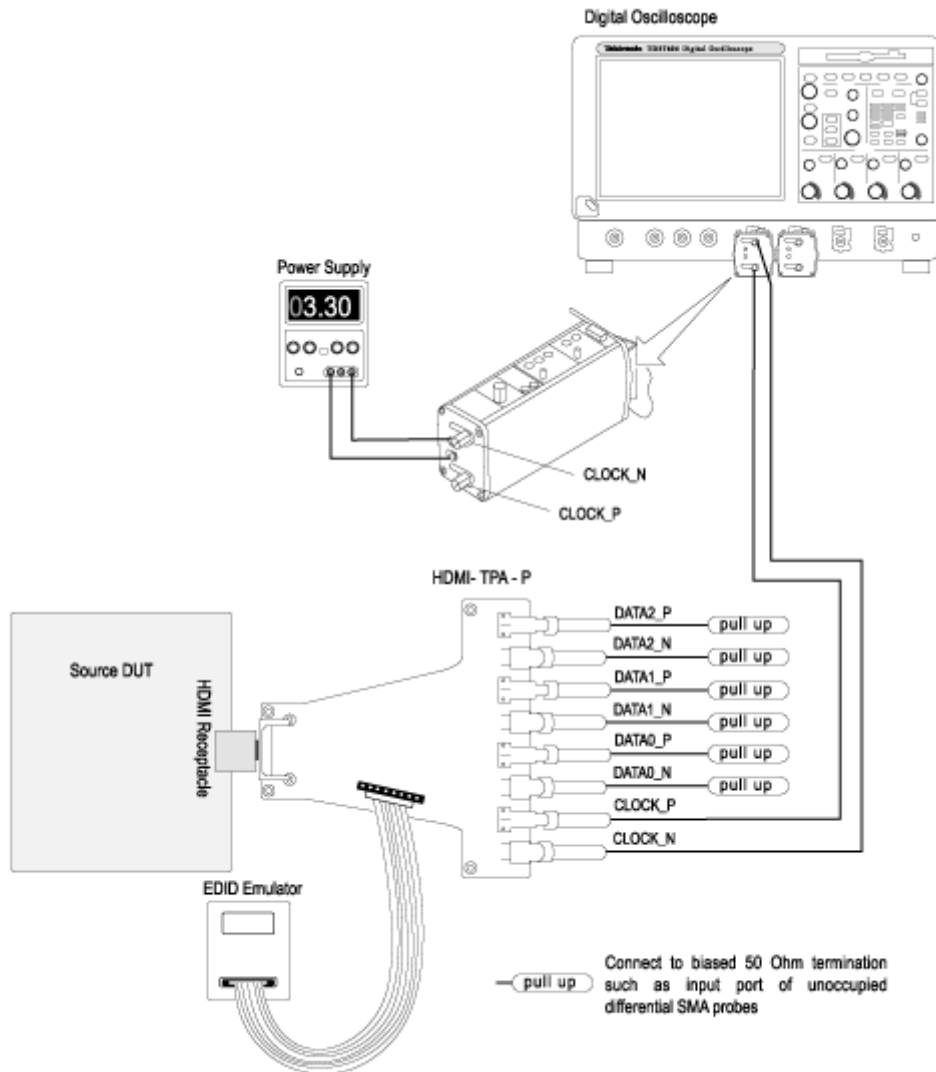

1. Connect the HDMI output of the source DUT to the TPA-P-DI/ ET-TPA-P adapter.
2. Connect a power supply to the TPA adapter and set the power supply to 3.30 V.

NOTE. For the DPO/DSA70000 series oscilloscopes with P7313 SMA probes and Efficere fixtures, you have the option to set the probe control voltage to **internal** from the [Preferences](#) menu. If this option is selected, an external power supply is not required.

3. Connect the EDID emulator to the TPA adapter and set the emulator for the required resolution (refer to the EDID emulator user manual).

4. Configure the Source DUT to output a video format with the required supported pixel clock frequency.
5. Connect a TMD5 Clock to the configured oscilloscope channel by using a differential probe.

Rise Time

On the menu bar, click **Tests > Connect** and make the connection as follows. Refer to [EDID Emulator for Source Tests](#) for EDID emulator connections.

Method 1: Connections for Source Rise Time

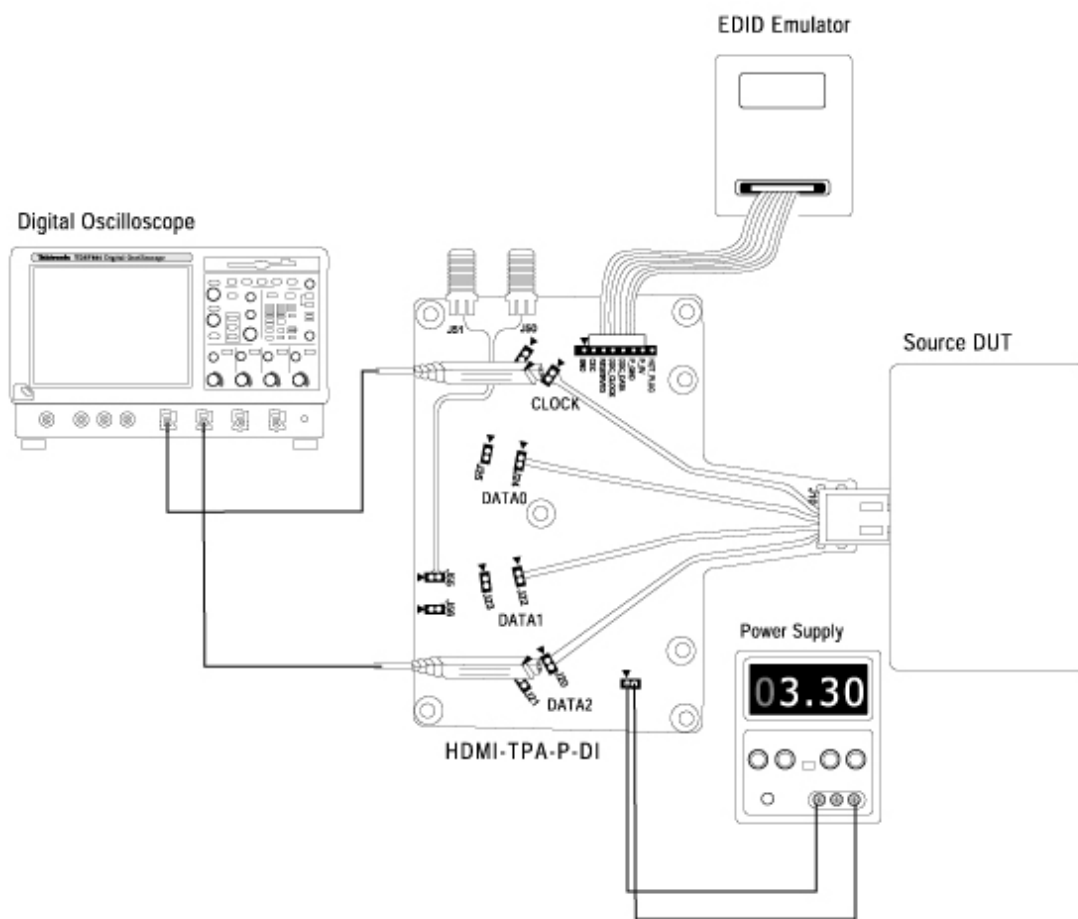

Method 2: Connections for Source Rise Time with Efficere Test Fixture

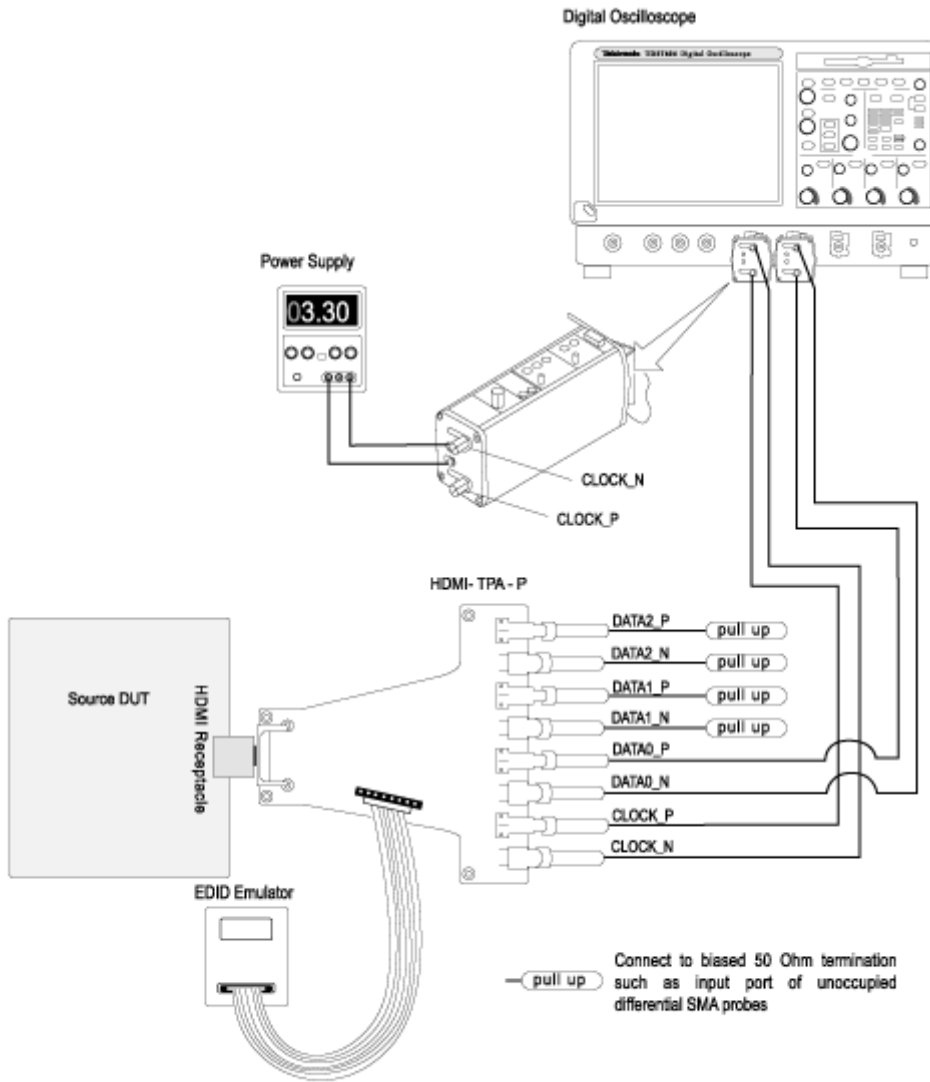

For 4-Channel

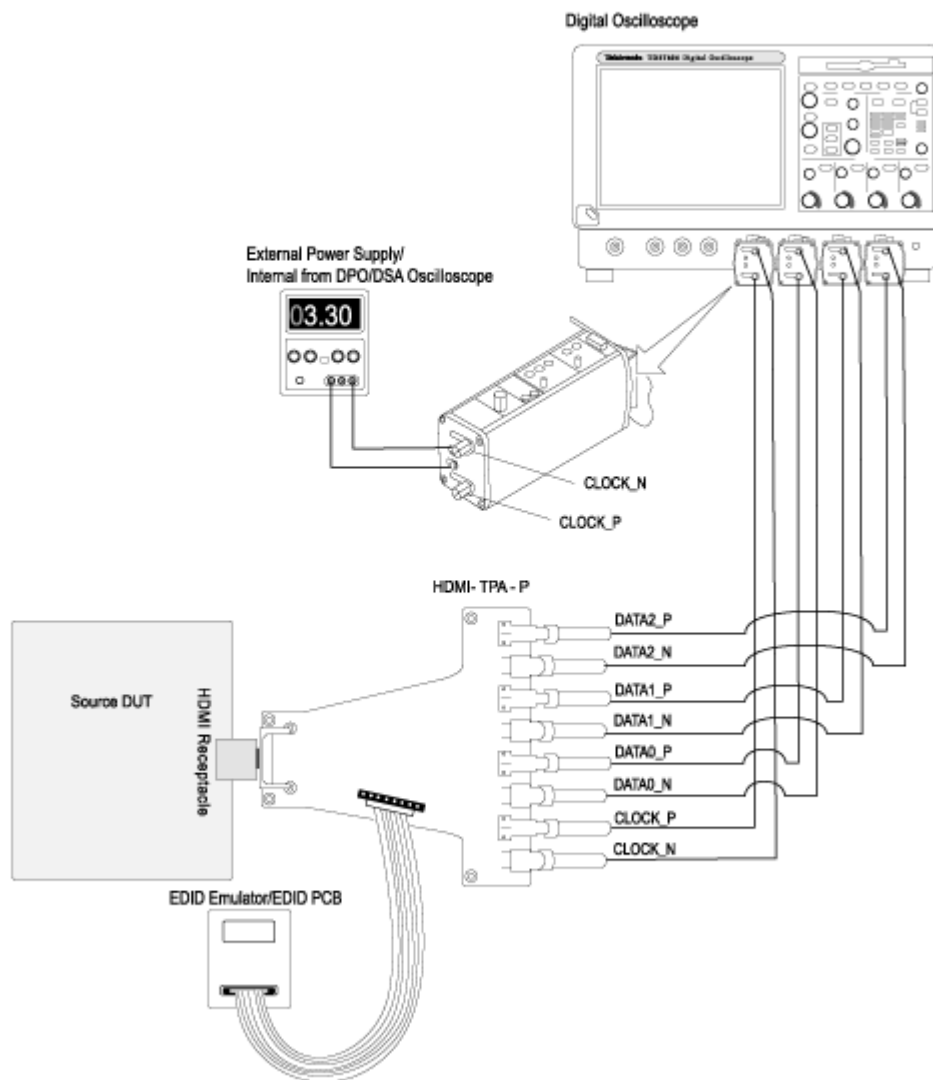

1. Connect the HDMI output of the source DUT to the TPA-P-DI/ ET-TPA-P adapter
2. Connect a power supply to the TPA adapter and set the power supply to 3.30 V.

NOTE. For the DPO/DSA70000 series oscilloscopes with P7313 SMA probes and Efficere fixtures, you have the option to set the probe control voltage to **internal** from the [Preferences](#) menu. If this option is selected, an external power supply is not required.

3. Connect the EDID emulator to the TPA adapter and set the emulator for the required resolution (refer to the EDID emulator user manual).
4. Configure the Source DUT to output a video format with the required supported pixel clock frequency.
5. Connect a differential probe(s) to a TMDS_DATA/CLOCK.
6. If you have selected “Re-calculate Tbit” in the configuration pane, then connect the clock channel to the configured oscilloscope channel by using a second differential probe(s).

Fall Time

On the menu bar, click **Tests > Connect** and make the connection as follows. Refer to [EDID Emulator for Source Tests](#) for EDID emulator connections.

Method 1: Connections for Source Fall Time

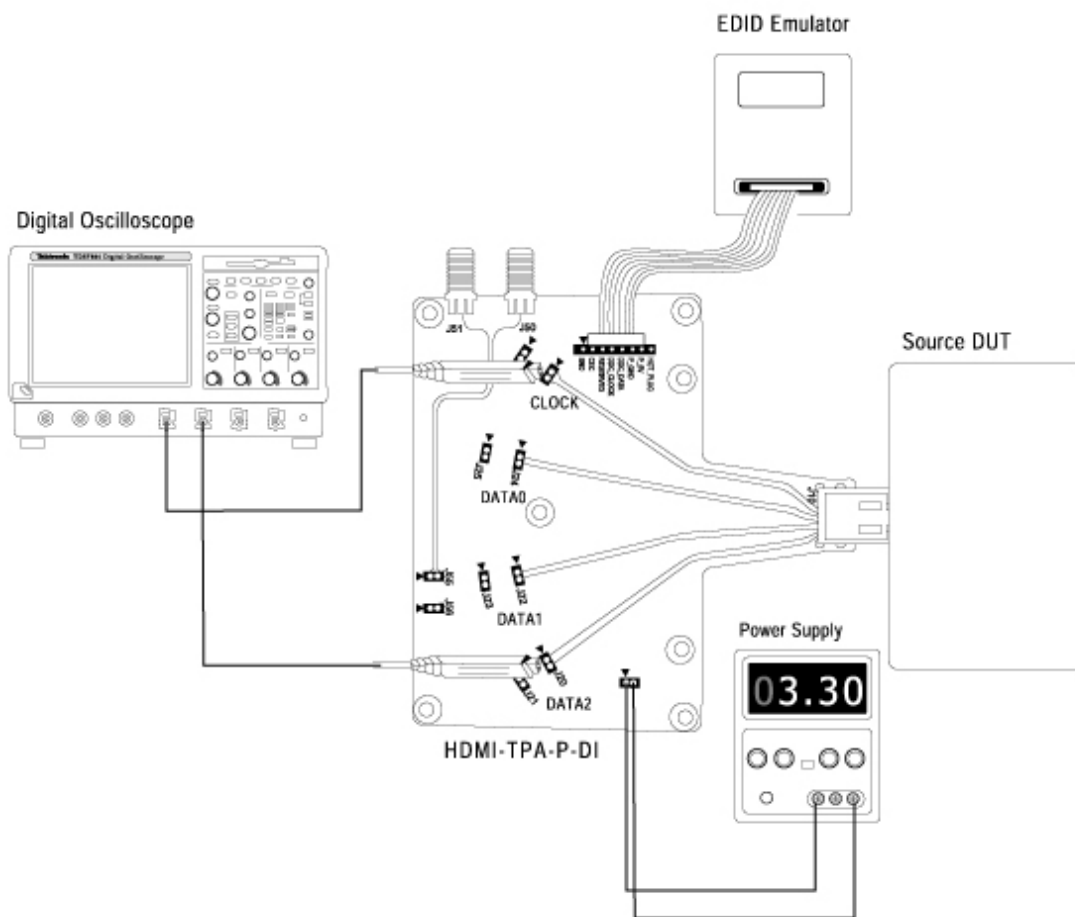

Method 2: Connections for Source Fall Time with Efficere Test Fixture

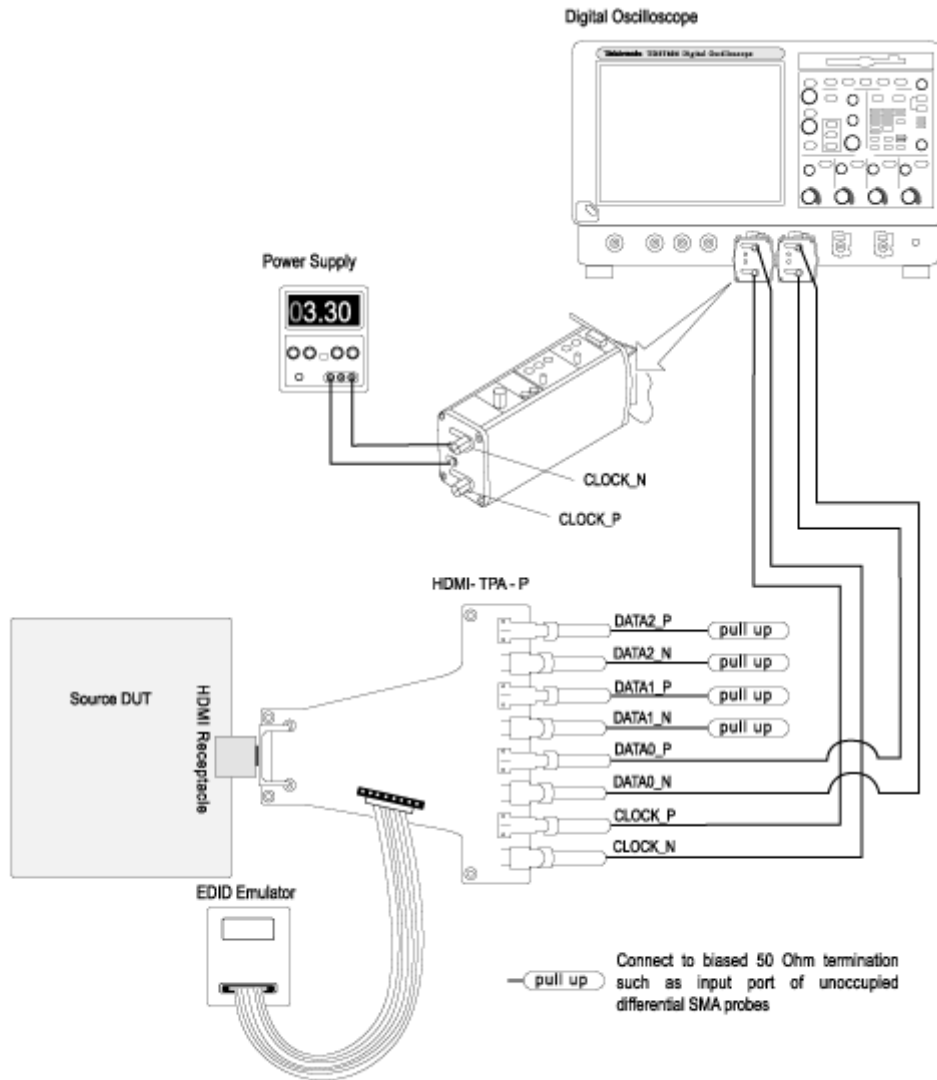

For 4-Channel

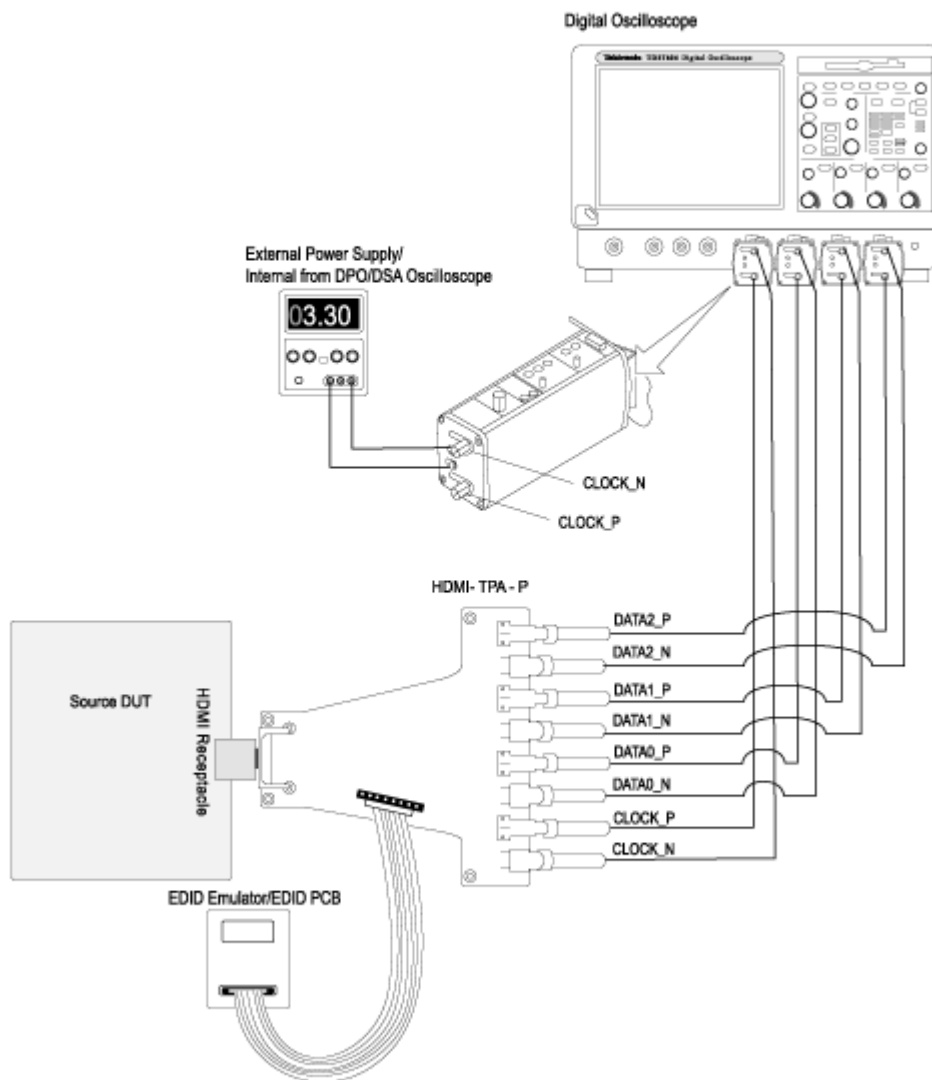

1. Connect the HDMI output of the source DUT to the TPA-P-DI/ET-TPA-P adapter.
2. Connect a power supply to the TPA adapter and set the power supply to 3.30 V.

NOTE. For the DPO/DSA70000 series oscilloscopes with P7313 SMA probes and Efficere fixtures, you have the option to set the probe control voltage to **internal** from the [Preferences](#) menu. If this option is selected, an external power supply is not required.

3. Connect the EDID emulator to the TPA adapter and set the emulator for the required resolution (refer to the EDID emulator user manual).
4. Configure the Source DUT to output a video format with the highest supported pixel clock frequency.
5. Connect a differential probe(s) to TMDS_DATA/CLOCK.
6. If you have selected “Re-calculate Tbit” in the configuration pane, then connect the clock channel to the configured oscilloscope channel by using a second differential probe(s).

Clock Jitter

On the menu bar, click **Tests > Connect** and make the connection as follows. Refer to [EDID Emulator for Source Tests](#) for EDID emulator connections.

Method 1: Connections for Source Clock Jitter

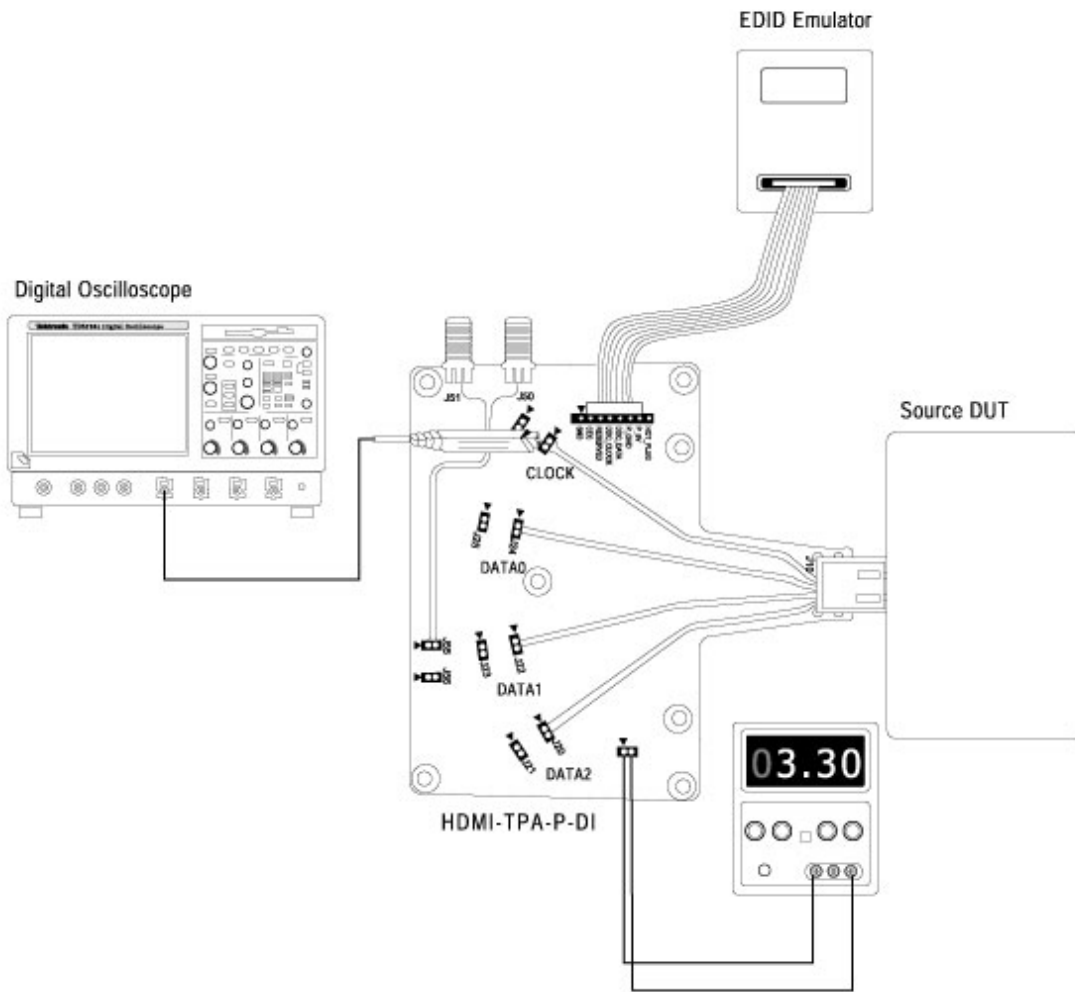

Method 2: Connections for Source Clock Jitter with Efficere Test Fixture

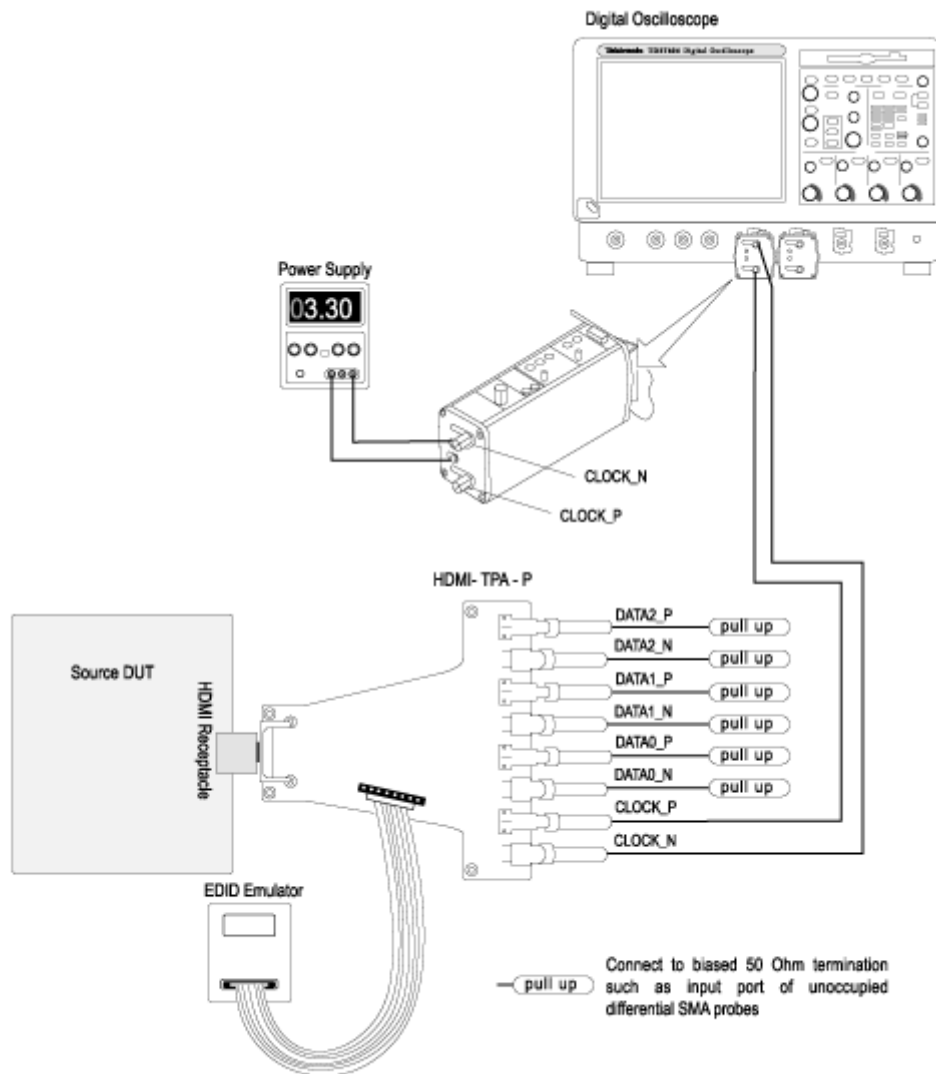

1. Connect the HDMI output of the source DUT to the TPA-P-DI/ET-TPA-P adapter.
2. Connect a power supply to the TPA adapter and set the power supply to 3.30 V.

NOTE. For the DPO/DSA70000 series oscilloscopes with P7313 SMA probes and Efficere fixtures, you have the option to set the probe control voltage to **internal** from the [Preferences](#) menu. If this option is selected, an external power supply is not required.

3. Connect the EDID emulator to the TPA adapter and set the emulator for the required resolution (refer to the EDID emulator user manual).

4. Configure the Source DUT to output a video format with the required supported pixel clock frequency.
5. Connect a TMDS Clock to the configured oscilloscope channel by using a differential probe.

Inter-Pair Skew

On the menu bar, click **Tests > Connect**. Refer to [EDID Emulator for Source Tests](#) for EDID emulator connections.

Setup 1

Use this setup if you selected “Re-calculate Tbit” in the configuration pane.

Make the connection as follows:

Method 1: Connections for Inter-Pair Skew (Re-calculate Tbit option selected)

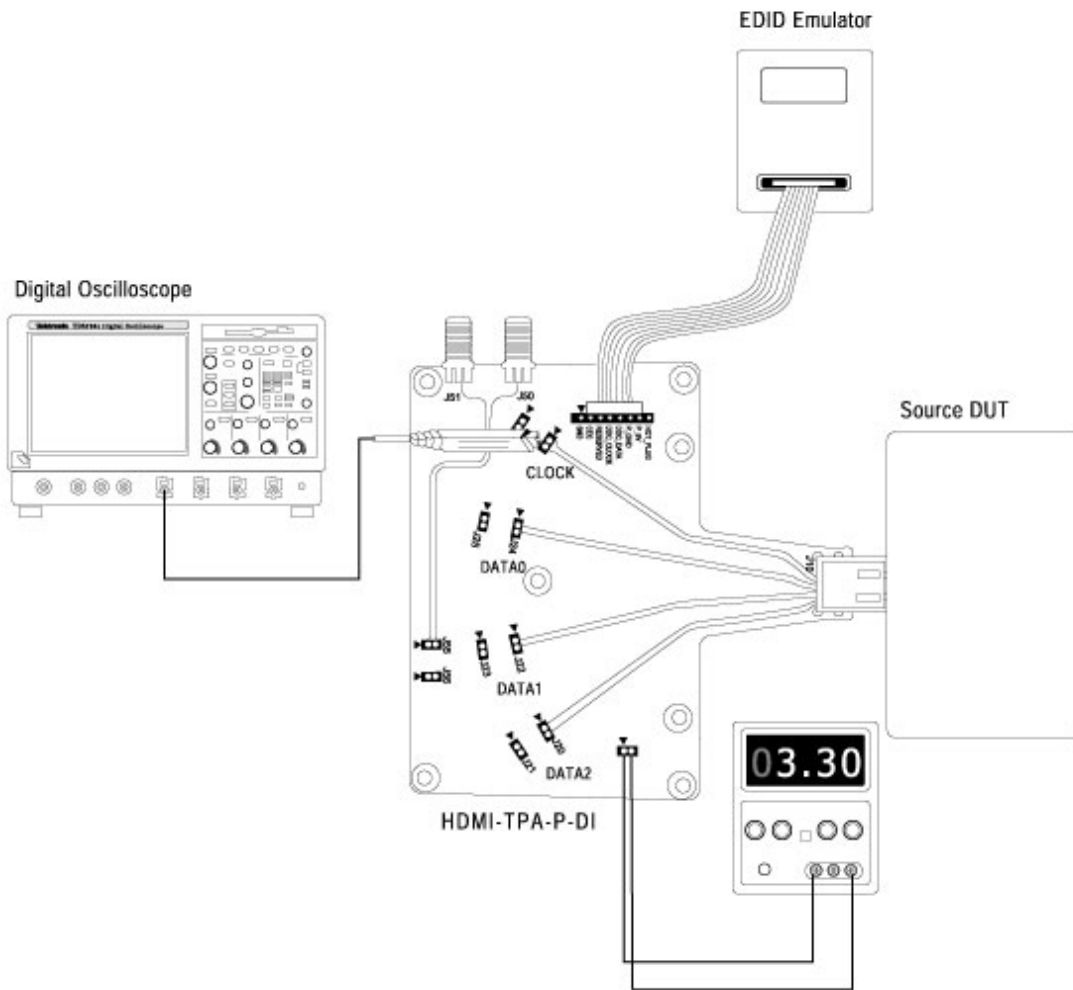

Method 2: Connections for Inter-Pair Skew with Efficere Test Fixture (Re-calculate Tbit option selected)

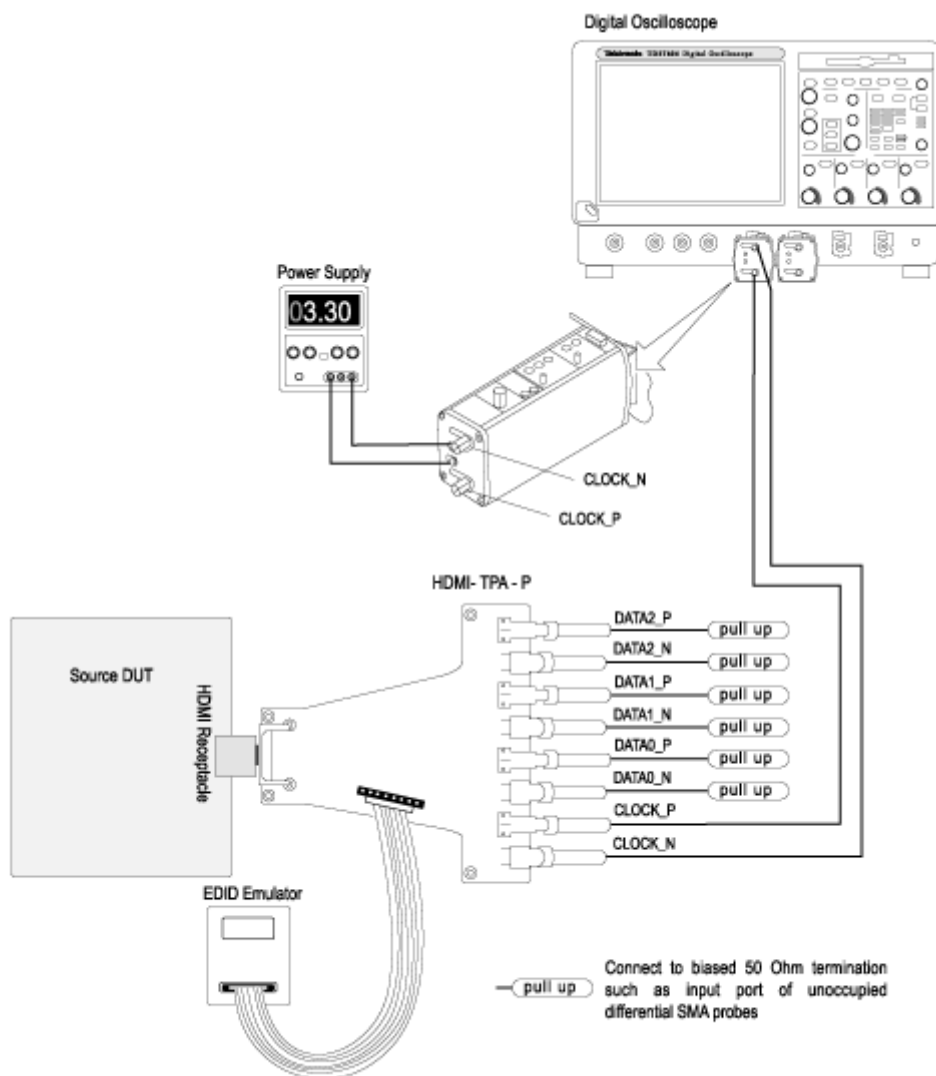

1. Connect the HDMI output of the source DUT to the TPA-P-DI/ET-TPA-P adapter.
2. Connect a power supply to the TPA adapter and set the power supply to 3.30 V.

NOTE. For the DPO/DSA70000 series oscilloscopes with P7313 SMA probes and Efficere fixtures, you have the option to set the probe control voltage to **internal** from the [Preferences](#) menu. If this option is selected, an external power supply is not required.

3. Connect the EDID emulator to the TPA adapter and set the emulator for the required resolution (refer to the EDID emulator user manual).
4. Configure the Source DUT to output a video format with the required supported pixel clock frequency.
5. Connect a TMD5 Clock to the configured oscilloscope channel by using a differential probe.

Setup 2

Use this setup if you selected “Existing Tbit” value or if you are calculating the inter-pair skew.

Make the connection as follows:

Method 1: Connections for Source Inter-Pair Skew (Existing Tbit option selected)

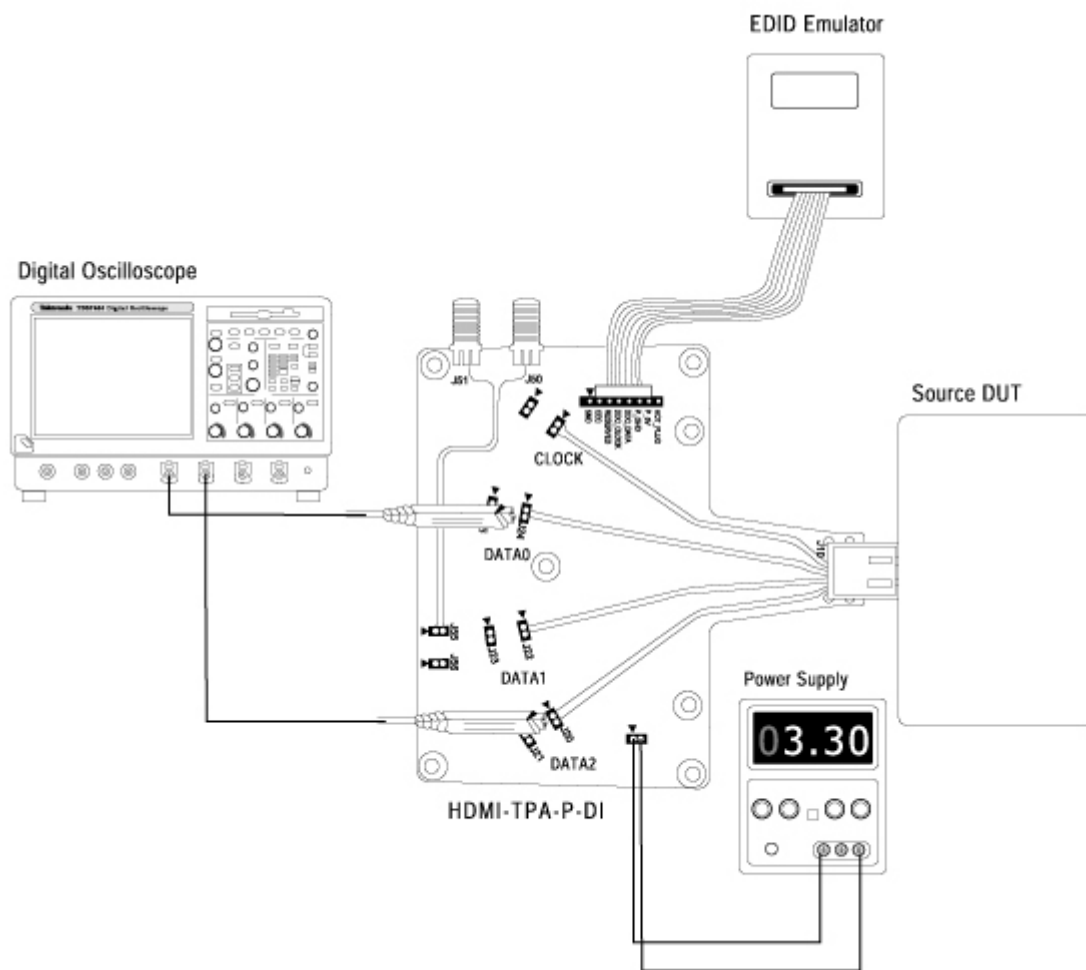

Method 2: Connections for Source Inter-Pair Skew with Efficere Test Fixture (Existing Tbit option selected)

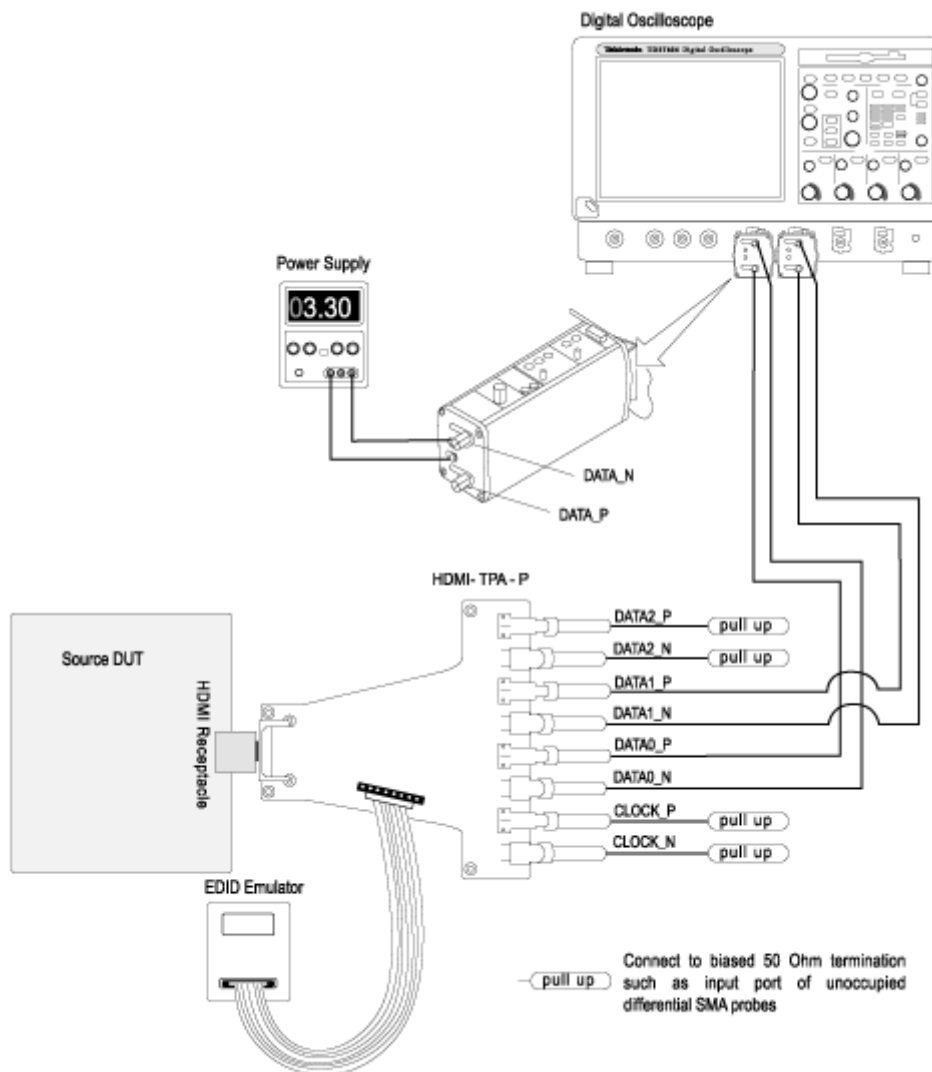

For 4-Channel

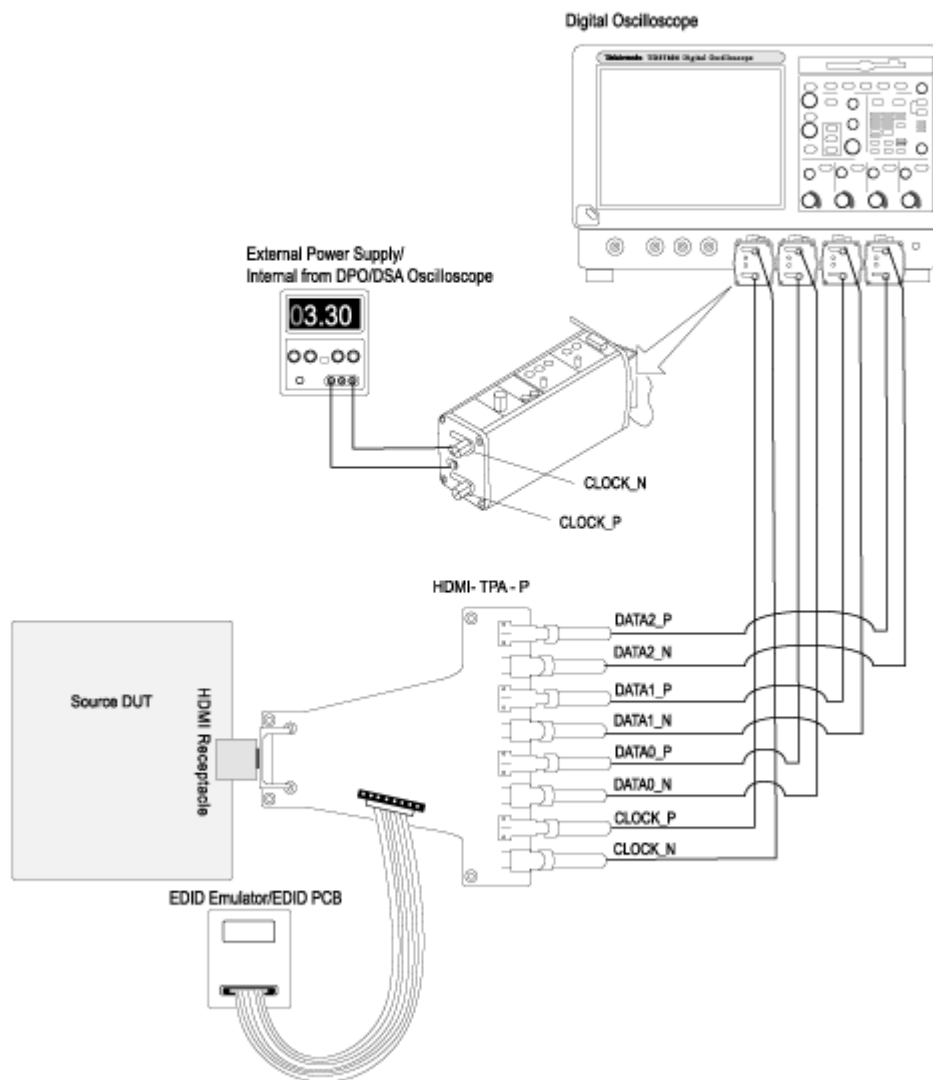

1. Connect the HDMI output of the source DUT to the TPA-P-DI/ET-TPA-P adapter.
2. Connect a power supply to the TPA adapter and set the power supply to 3.30 V.

NOTE. For the DPO/DSA70000 series oscilloscopes with P7313 SMA probes and Efficere fixtures, you have the set to enable the probe control voltage to **internal** from the [Preferences](#) menu. If this option is selected, an external power supply is not required.

3. Connect the EDID emulator to the TPA adapter and set the emulator for the required resolution (refer to the EDID emulator user manual).
4. Connect the TMDS_CLOCK to the configured oscilloscope channel by using a differential probe.
5. Connect a TMDS_DATA<X> to the configured oscilloscope channel by using a second differential probe.
6. Connect the TMDS_DATA<Y> pair on which you will conduct the test to the configured oscilloscope channel by using a third differential probe.
7. Connect the TMDS_DATA<Z> pair on which you will conduct the test to the configured oscilloscope channel by using a fourth differential probe.
8. Configure the Source DUT to output the required video format.

Differential Tests Select All

On the menu bar, click **Tests > Connect** and make the connection as follows. Refer to [EDID Emulator for Source Tests](#) for EDID emulator connections.

Method 1: Connections for Source Differential tests (with Select All option)

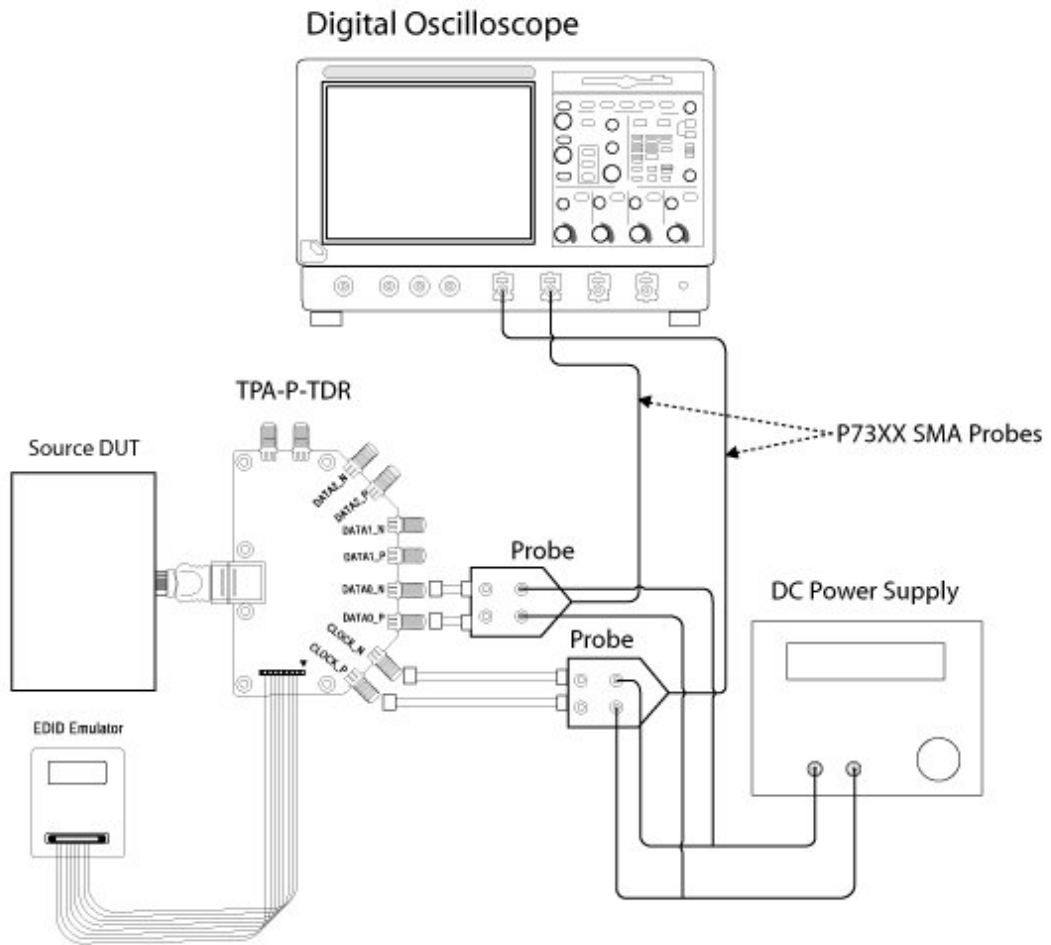

Method 2: Connections for Source Differential tests with Efficere Test Fixture (Select All option)

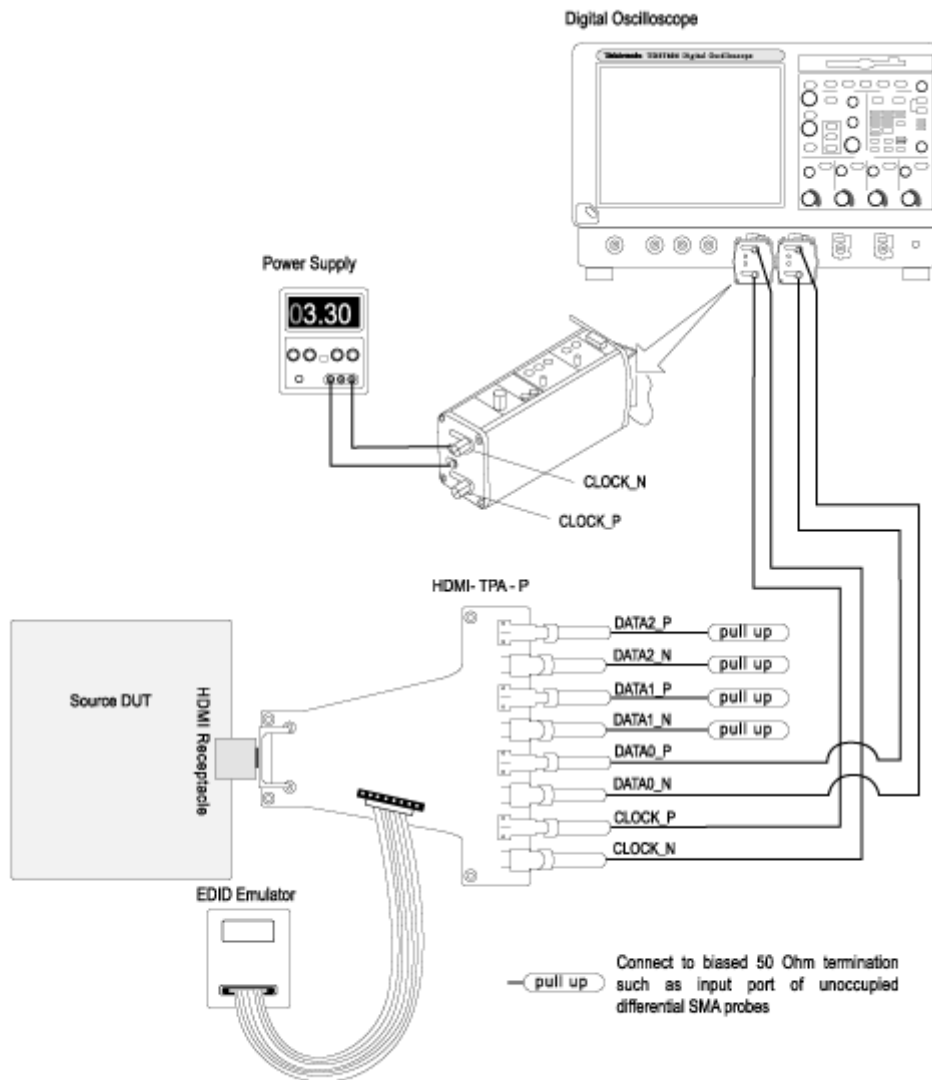

For 4-Channel

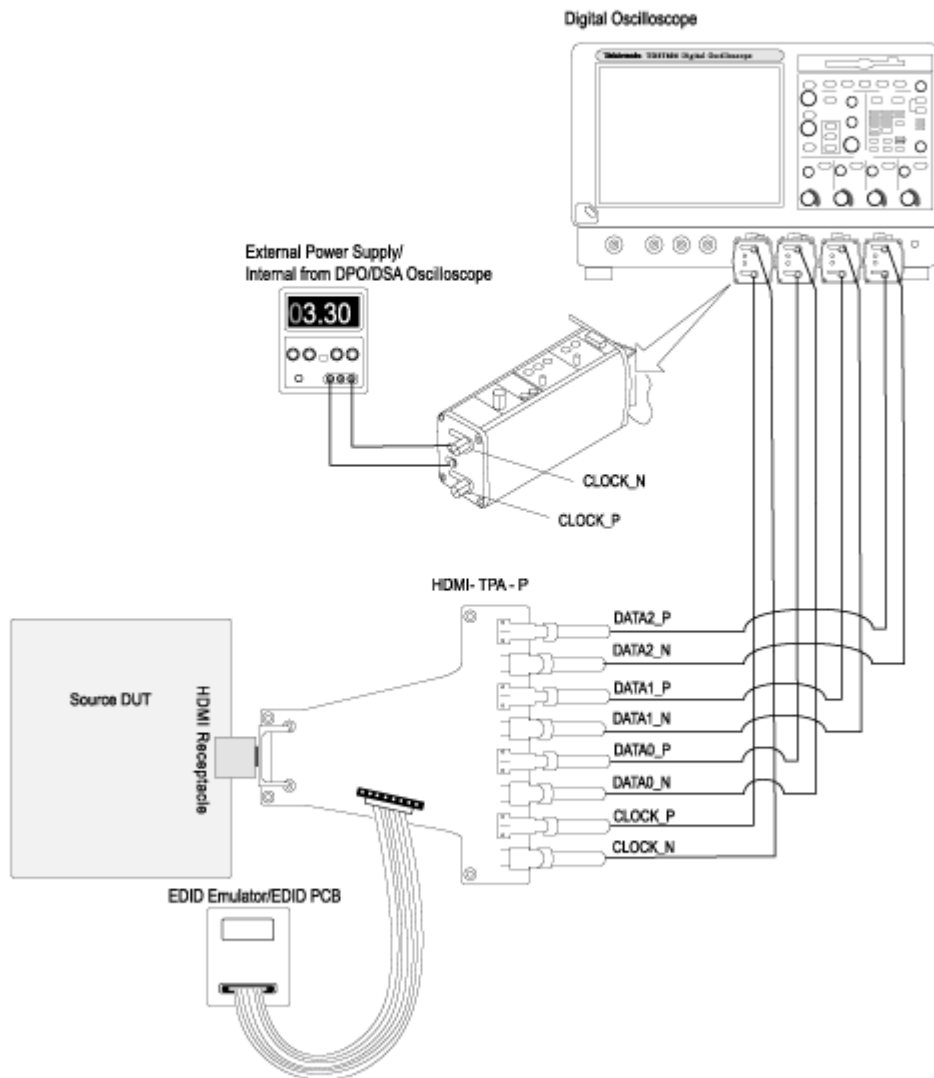

1. Connect the HDMI output of the source DUT to the TPA-P-DI/ET-TPA-P adapter.
2. Connect a power supply to the TPA adapter and set the power supply to 3.30 V.

NOTE. For the DPO/DSA70000 series oscilloscopes with P7313 SMA probes and Efficere fixtures, you have the option to set the probe control voltage to **internal** from the [Preferences](#) menu. If this option is selected, an external power supply is not required.

3. Connect the EDID emulator to the TPA adapter and set the emulator for the required resolution (refer to the EDID emulator user manual).
4. Connect a TMDS Clock to the configured oscilloscope channel by using a differential probe.
5. Connect the TMDS_DATA pair(s) on which you will conduct the test to the configured oscilloscope channel by using a second differential probe(s).
6. Configure the Source DUT to output the required video format.

Intra-Pair Skew (Source)

On the menu bar, click **Tests > Connect**. Refer to [EDID Emulator for Source Tests](#) for EDID emulator connections.

Setup 1

Use this setup if you have selected “Re-calculate Tbit” in the configuration pane.

Make the connection as follows:

Method 1: Connections for Source Intra-Pair Skew test (Re-calculate Tbit option selected)

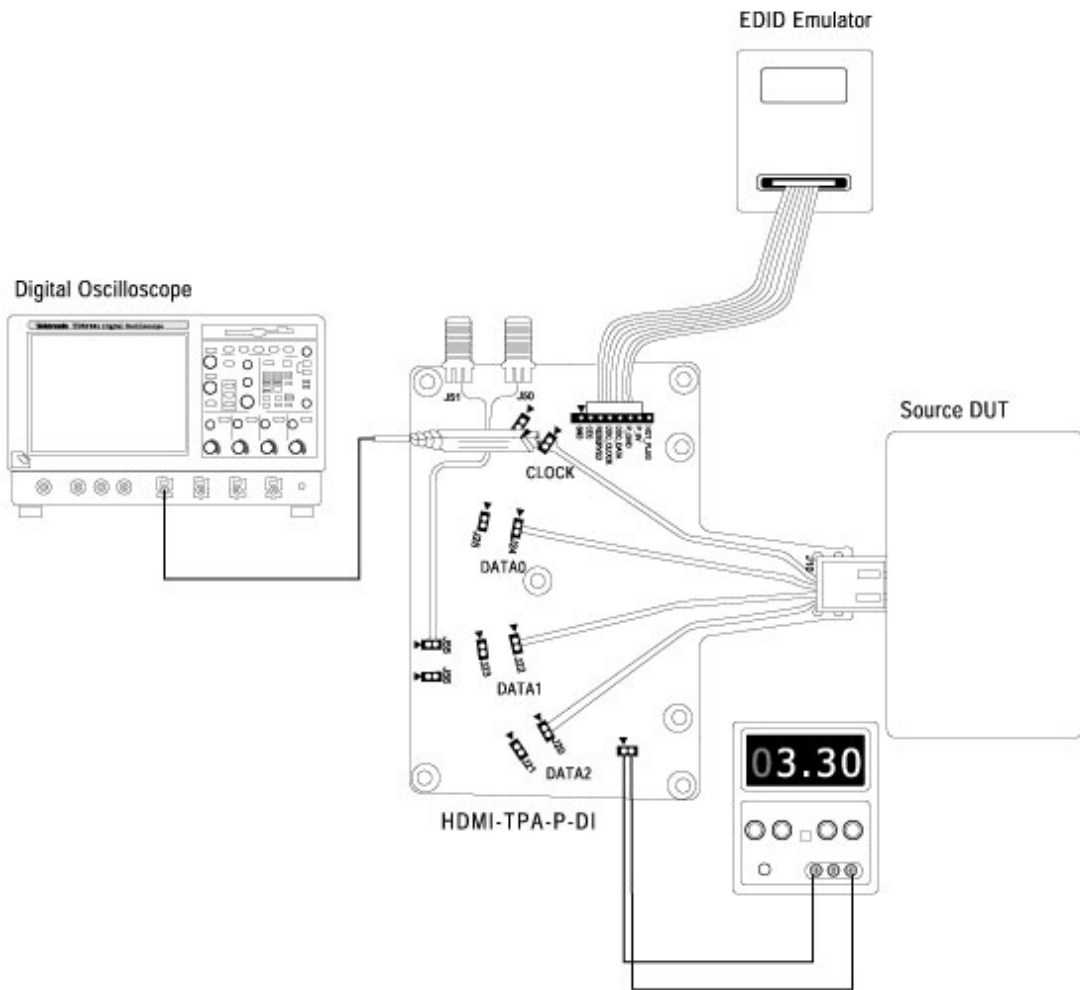

Method 2: Connections for Source Intra-Pair Skew test with Efficere Test Fixture (Re-calculate Tbit option selected)

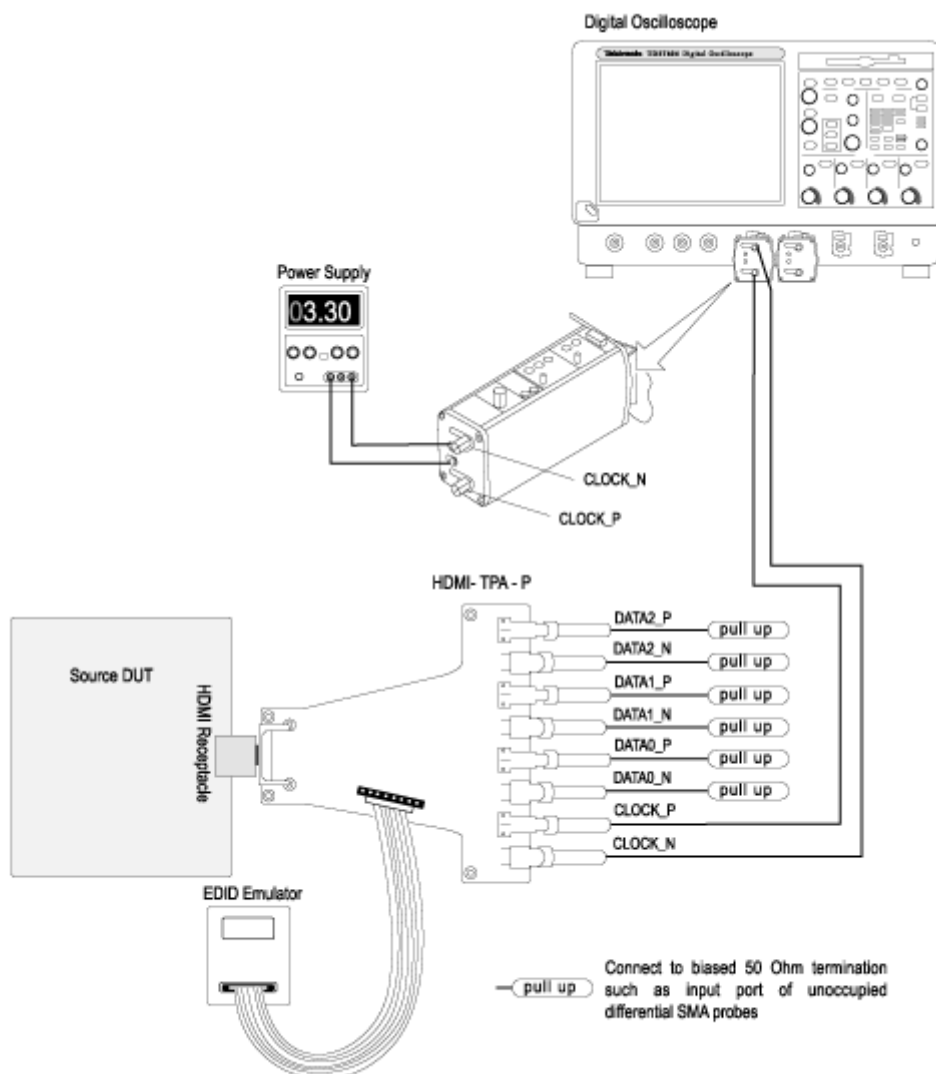

1. Connect the HDMI output of the source DUT to the TPA-P-DI/ET-TPA-P adapter.
2. Connect a power supply to the TPA adapter and set the power supply to 3.30 V.

NOTE. For the DPO/DSA70000 series oscilloscopes with P7313 SMA probes and Efficere fixtures, you have the option to set the probe control voltage to **internal** from the [Preferences](#) menu. If this option is selected, an external power supply is not required.

3. Connect the EDID emulator to the TPA adapter and set the emulator for the required resolution (refer to the EDID emulator user manual).
4. Configure the Source DUT to output a video format with the required supported pixel clock frequency.
5. Connect a TMD5 Clock to the configured oscilloscope channel by using a differential probe.

Setup 2

Use this setup if you have selected “Existing Tbit” value or if you are calculating the intra-pair skew.

Make the connection as follows:

Method 1: Connections for Source Intra-Pair Skew test (Existing Tbit option selected)

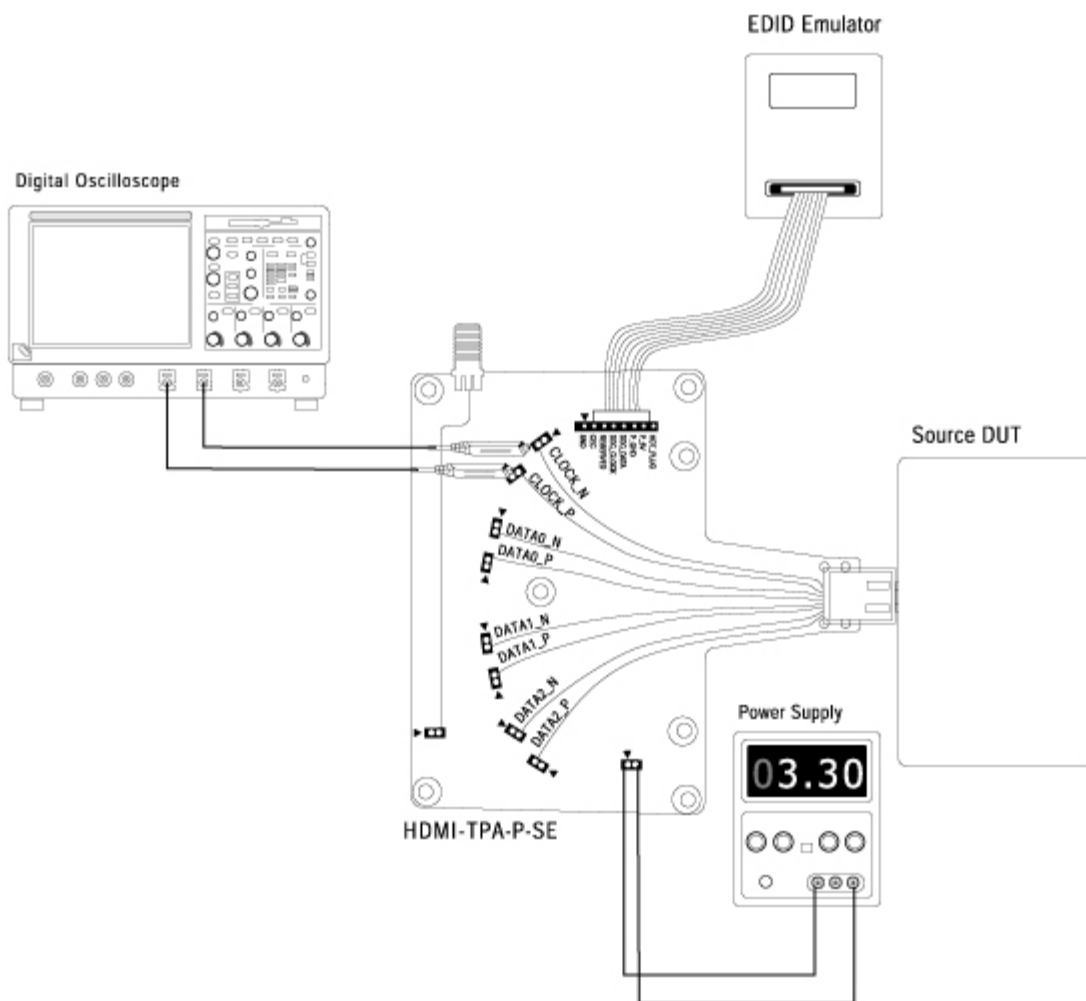

Method 2: Connections for Source Intra-Pair Skew test with Efficere Test Fixture (Existing Tbit option selected)

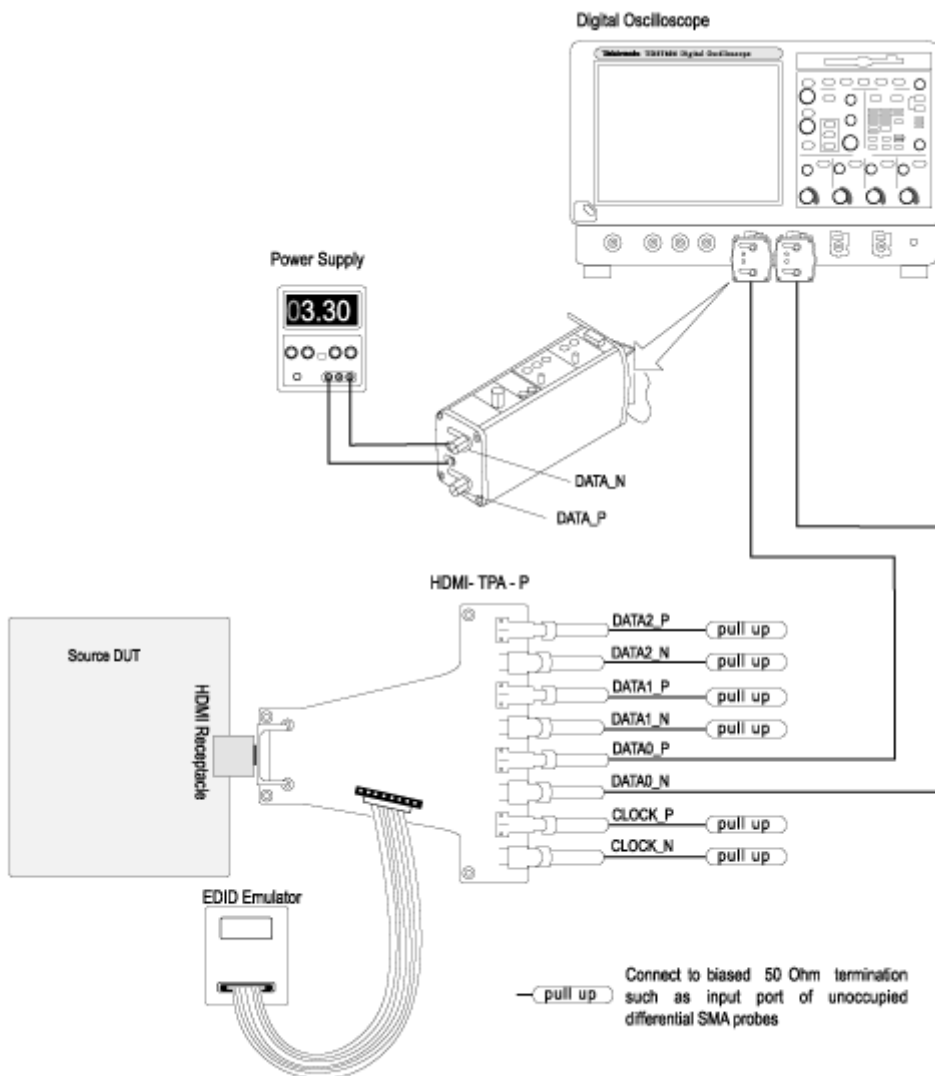

For 4-Channel

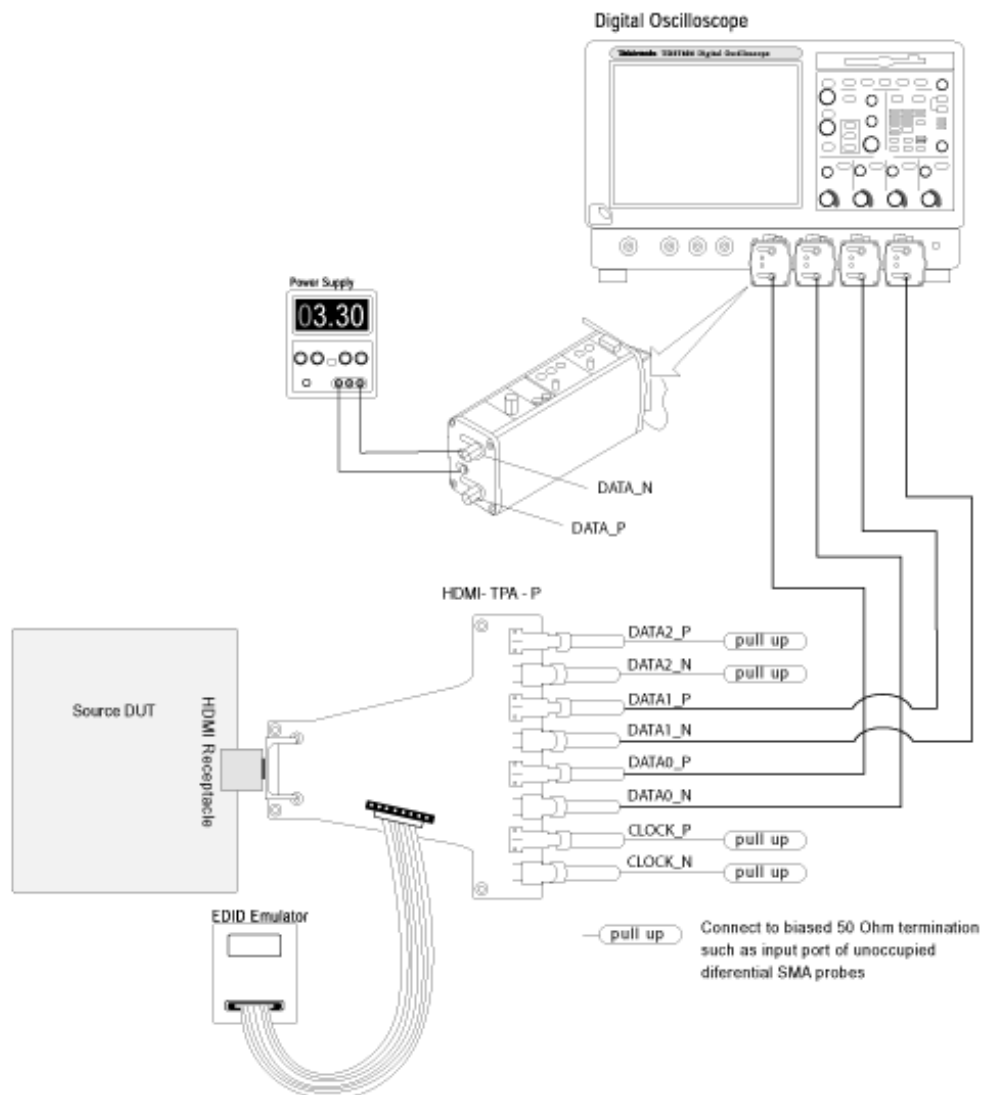

1. Connect the HDMI output of the source DUT to the TPA-P-SE/ET-TPA-P adapter.
2. Connect a power supply to the TPA adapter and set the power supply to 3.30 V.

NOTE. For the DPO/DSA70000 series oscilloscopes with P7313 SMA probes and Efficere fixtures, you have the option to set the probe control voltage to **internal** from the [Preferences](#) menu. If this option is selected, an external power supply is not required.

3. Connect the EDID emulator to the TPA adapter and set the emulator for the required resolution (refer to the EDID emulator user manual).
4. Connect the first single-ended probe to TMDS_DATA<X>+/TMDS_CLOCK+.
5. Connect the second single-ended probe to TMDS_DATA<X>- /TMDS_CLOCK-.
6. Connect the third single-ended probe to TMDS_DATA<X>+/TMDS_CLOCK+.
7. Connect the fourth single-ended probe to TMDS_DATA<X>- /TMDS_CLOCK-.
8. Configure the Source DUT to output a video format with the required supported pixel clock frequency.

Low Amplitude +

On the menu bar, click **Tests > Connect**. Refer to [EDID Emulator for Source Tests](#) for EDID emulator connections.

Setup 1

Use this setup if you have selected “Re-calculate Tbit” in the configuration pane.

Make the connection as follows:

Method 1: Connections for Low Amplitude + (Re-calculate Tbit option selected)

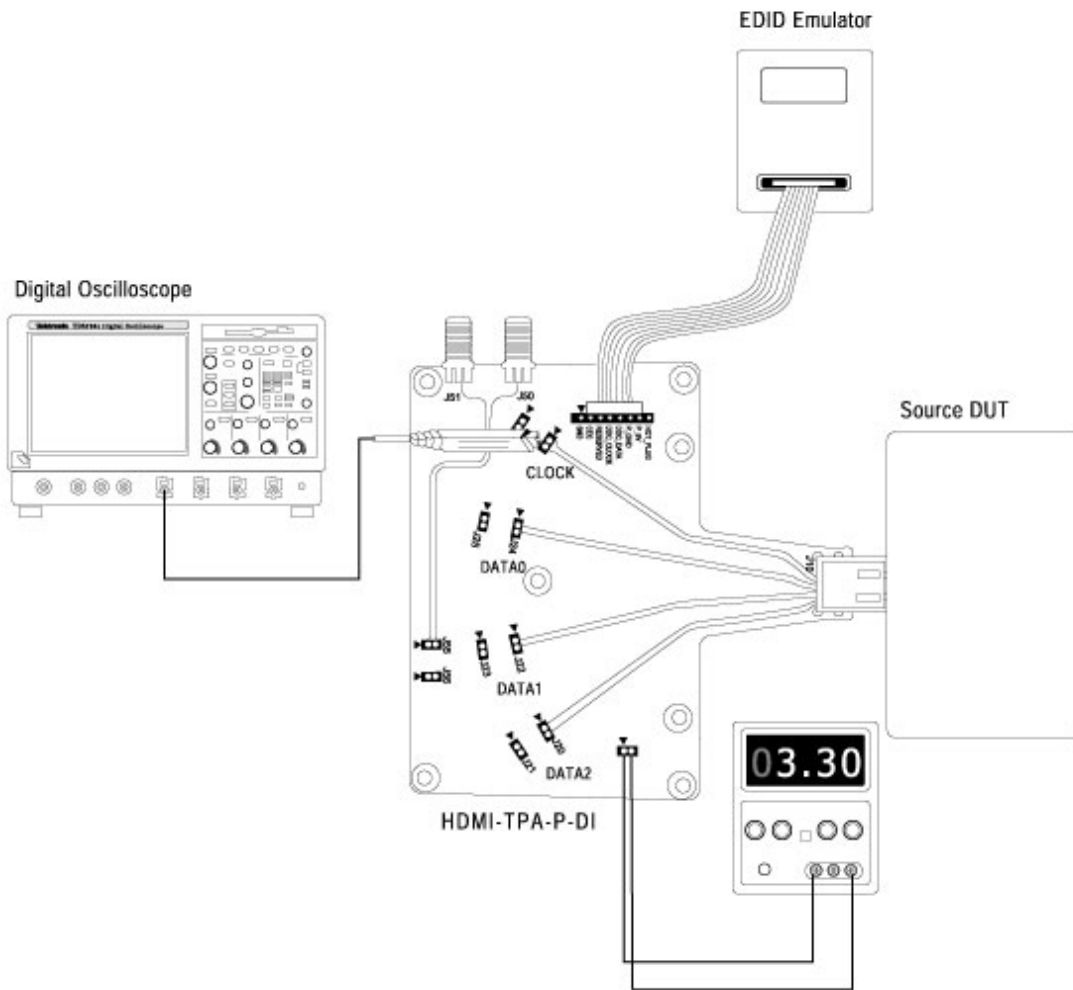

Method 2: Connections for Low Amplitude + with Efficere Test Fixture (Re-calculate Tbit option selected)

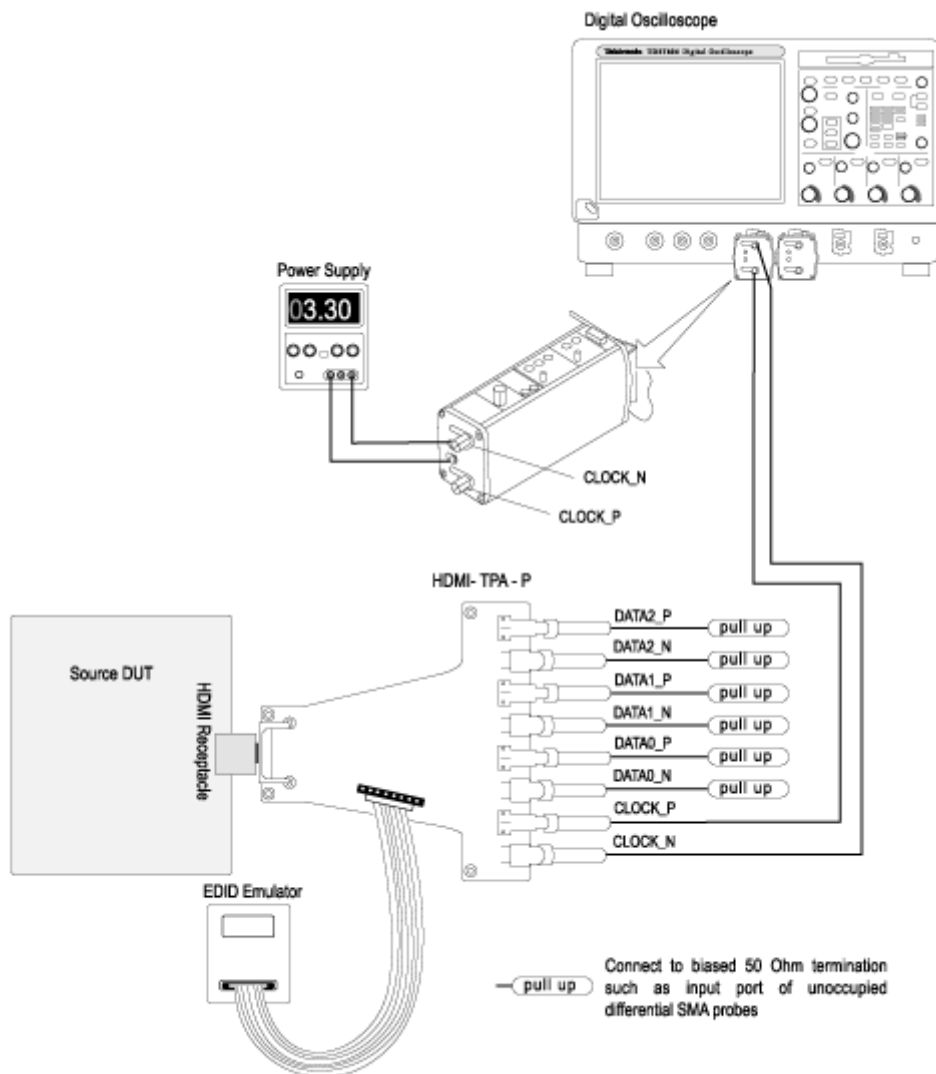

1. Connect the HDMI output of the source DUT to the TPA-P-DI/ ET-TPA-P adapter.
2. Connect a power supply to the TPA adapter and set the power supply to 3.30 V.

NOTE. For the DPO/DSA70000 series oscilloscopes with P7313 SMA probes and Efficere fixtures, you have the option to set the probe control voltage to **internal** from the [Preferences](#) menu. If this option is selected, an external power supply is not required.

3. Connect the EDID emulator to the TPA adapter and set the emulator for the required resolution (refer to the EDID emulator user manual).
4. Configure the Source DUT to output a video format with the required supported pixel clock frequency.
5. Connect a TMD5 Clock to the configured oscilloscope channel by using a differential probe.

Setup 2

Use this setup if you have selected “Existing Tbit” value or if you are calculating low amplitude.

Make the connection as follows:

Method 1: Connections for Low Amplitude + (Existing Tbit option selected)

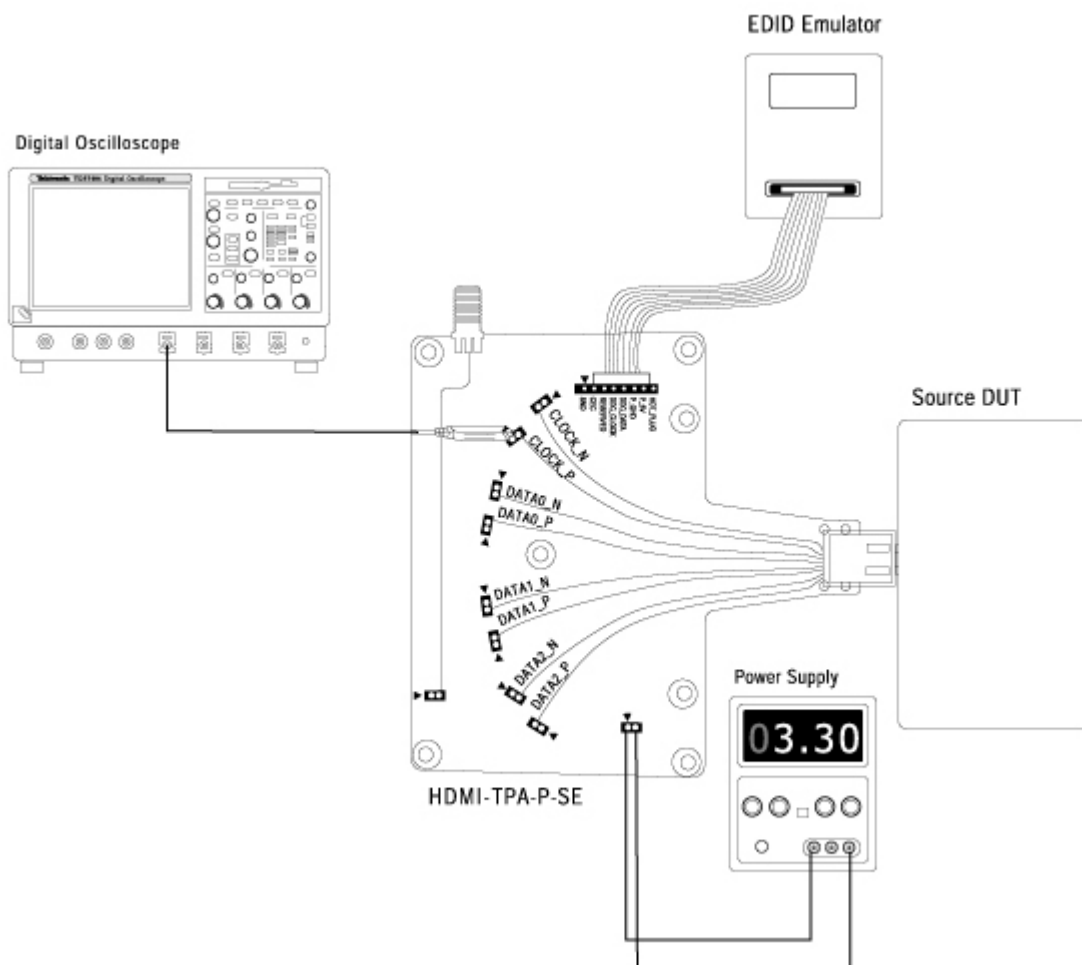

Method 2: Connections for Low Amplitude + with Efficere Test Fixture (Existing Tbit option selected)

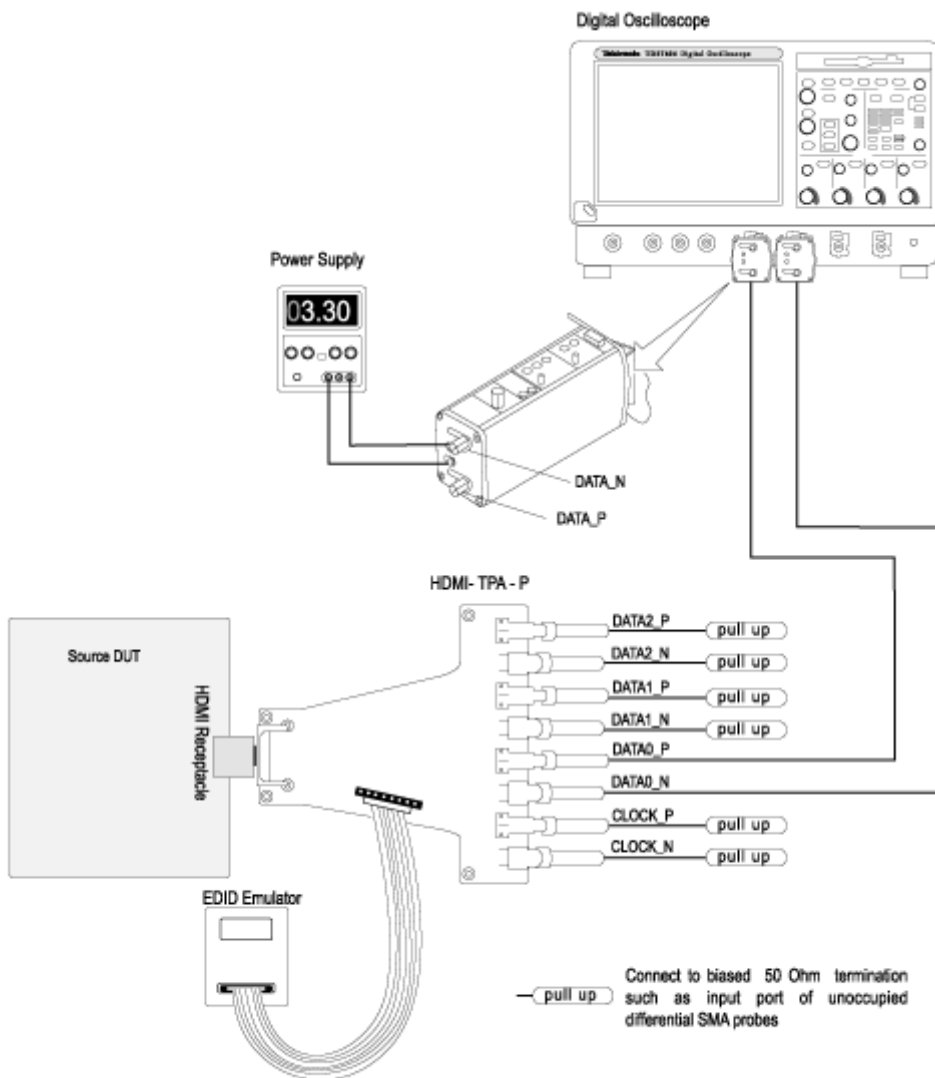

For 4-Channel

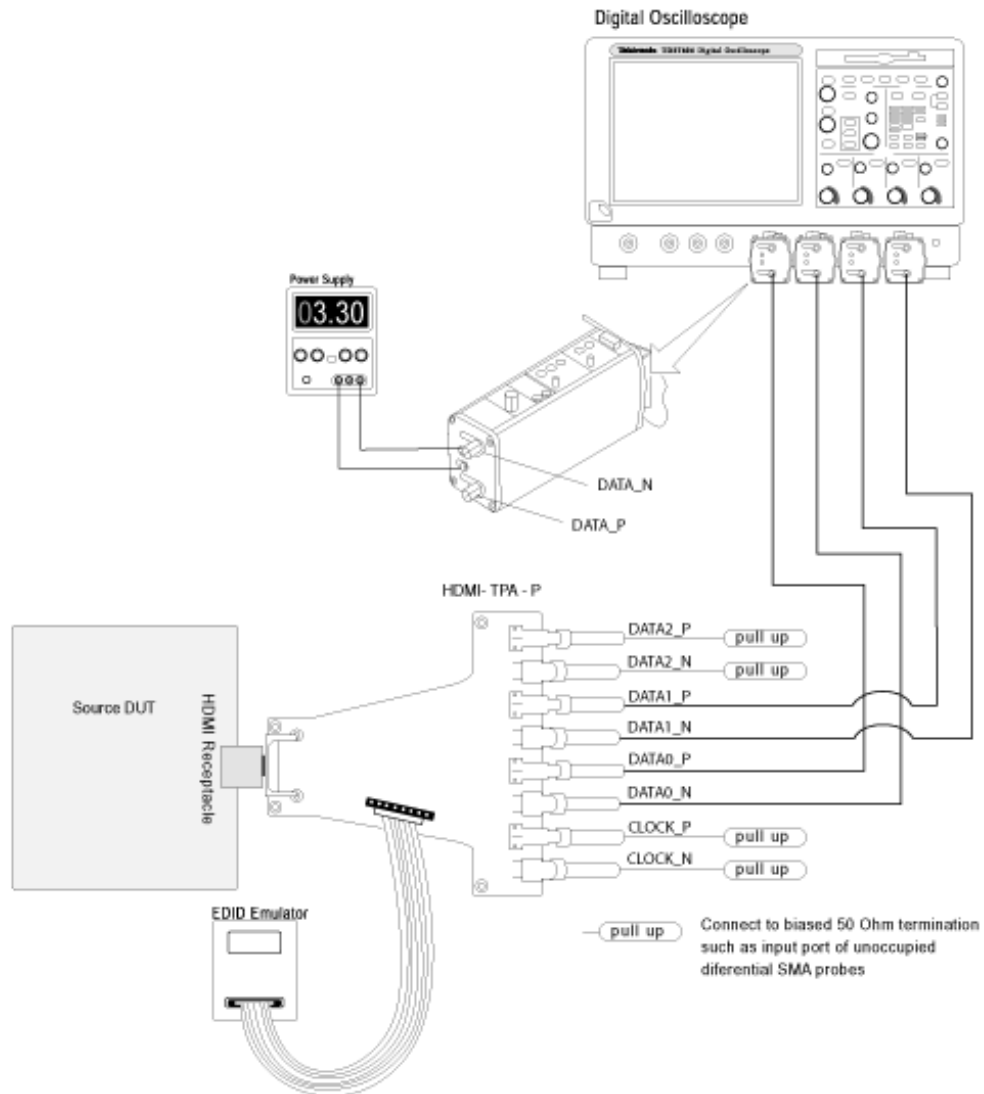

NOTE. *Connecting CH2 and Ch4 is not a must for this measurement.*

1. Connect the HDMI output of the source DUT to the TPA-P-SE/ ET-TPA-P adapter.
2. Connect a power supply to the TPA adapter and set the power supply to 3.30 V.

NOTE. For the DPO/DSA70000 series oscilloscopes with P7313 SMA probes and Efficere fixtures, you have the option to set the probe control voltage to **internal** from the [Preferences](#) menu. If this option is selected, an external power supply is not required.

3. Connect the EDID emulator to the TPA adapter and set the emulator for the required resolution (refer to the EDID emulator user manual).
4. Connect the first single-ended probe to TMDS_DATA<X>+/ TMDS_CLOCK+.
5. Connect the second single-ended probe to TMDS_DATA<X>+/ TMDS_CLOCK+.
6. Configure the Source DUT to output a video format with the required supported pixel clock frequency.

Low Amplitude -

On the menu bar, click **Tests > Connect**. Refer to [EDID Emulator for Source Tests](#) for EDID emulator connections.

Setup 1

Use this setup if you have selected “Re-calculate Tbit” in the configuration pane.

Make the connection as follows:

Method 1: Connections for Low Amplitude – (Re-calculate Tbit option selected)

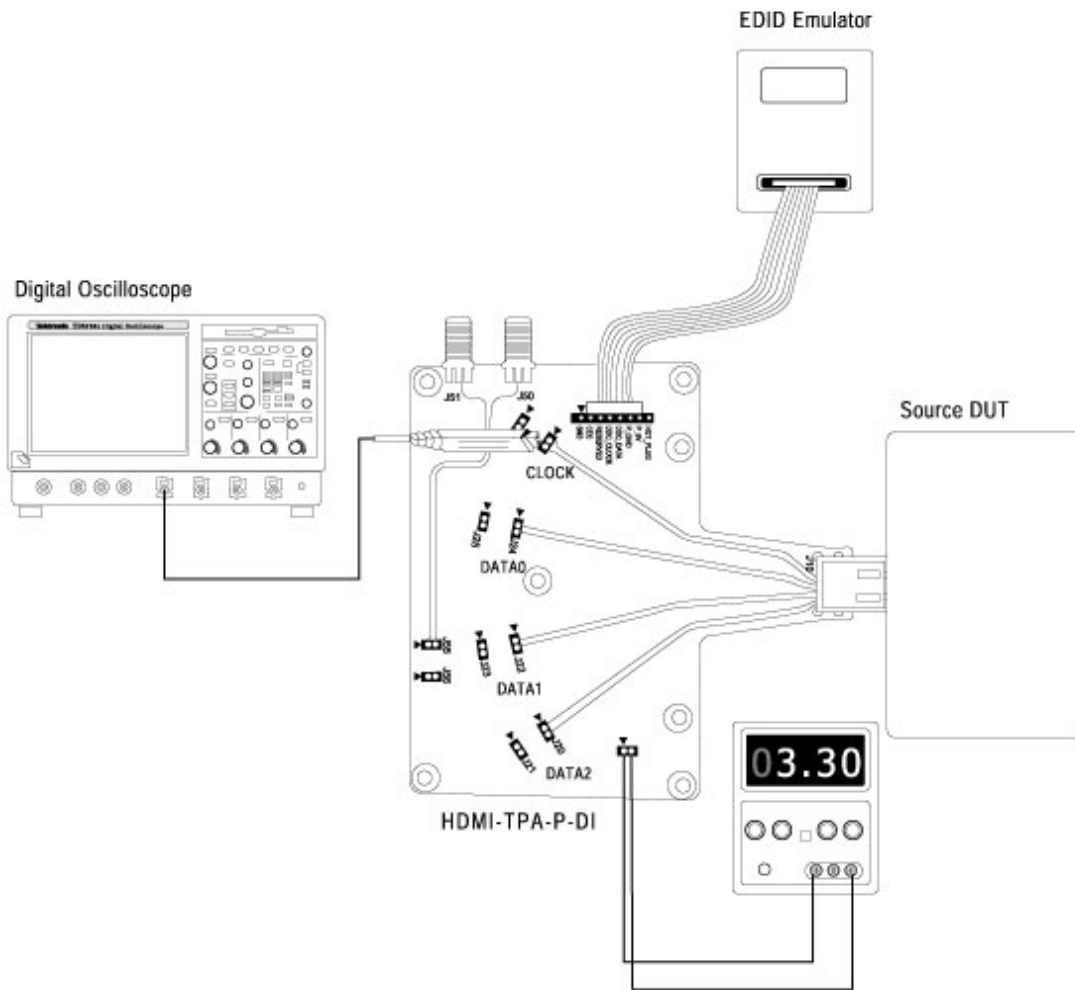

Method 2: Connections for Low Amplitude – with Efficere Test Fixture (Re-calculate Tbit option selected)

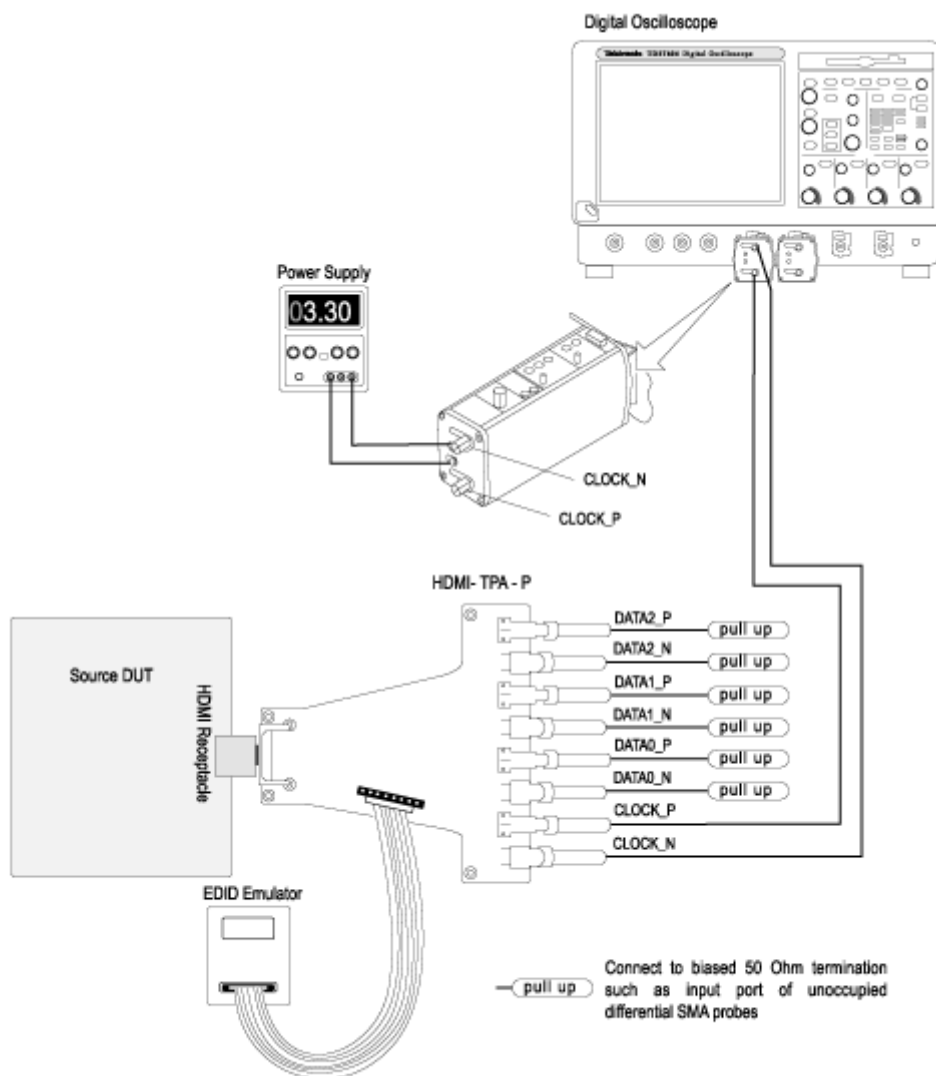

1. Connect the HDMI output of the source DUT to the TPA-P-DI/ET-TPA-P adapter.
2. Connect a power supply to the TPA adapter and set the power supply to 3.30 V.

NOTE. For the DPO/DSA70000 series oscilloscopes with P7313 SMA probes and Efficere fixtures, you have the option to set the probe control voltage to **internal** from the [Preferences](#) menu. If this option is selected, an external power supply is not required.

3. Connect the EDID emulator to the TPA adapter and set the emulator for the required resolution (refer to the EDID emulator user manual).
4. Configure the Source DUT to output a video format with the required supported pixel clock frequency.
5. Connect a TMD5 Clock to the configured oscilloscope channel by using a differential probe.

Setup 2

Use this setup if you have selected “Existing Tbit” value or if you are calculating low amplitude.

Make the connection as follows:

Method 1: Connections for Low Amplitude - (Existing Tbit option selected)

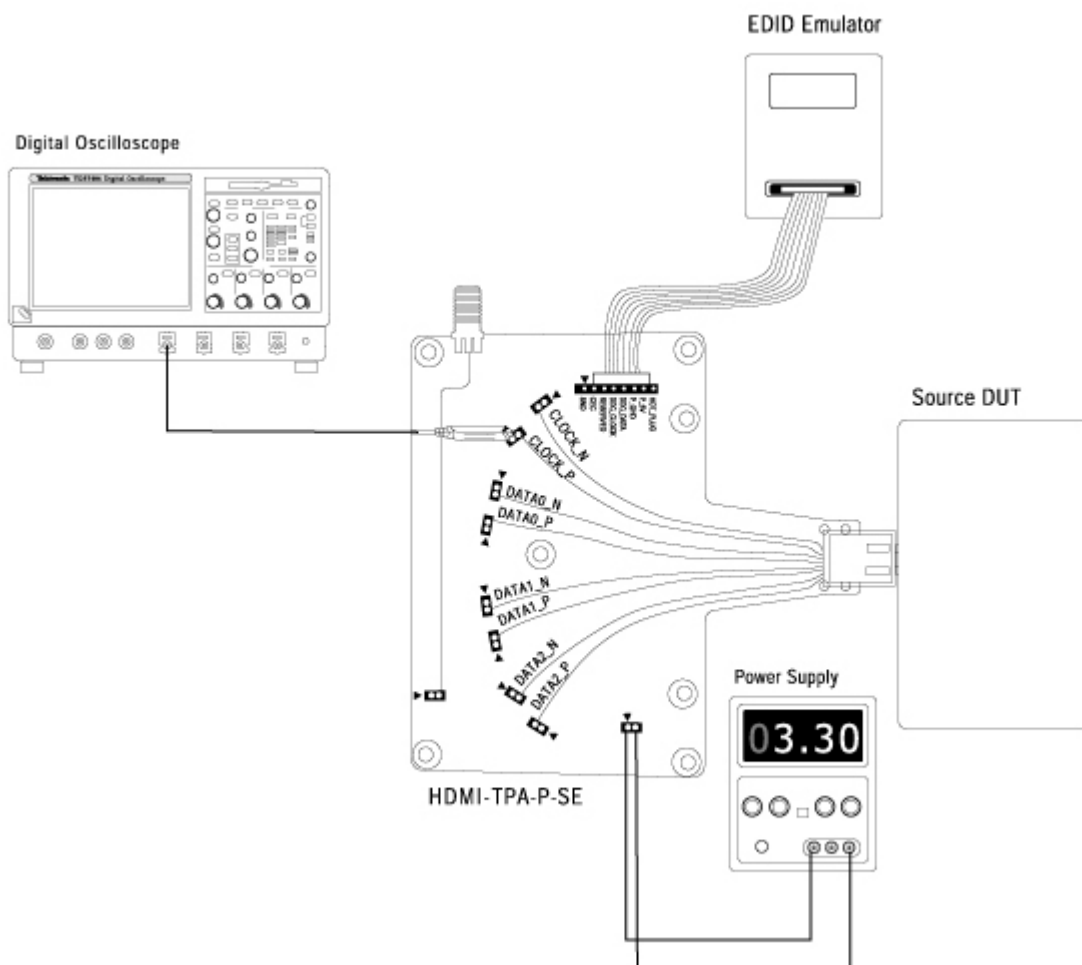

Method 2: Connections for Low Amplitude - with Efficere Test Fixture (Existing Tbit option selected)

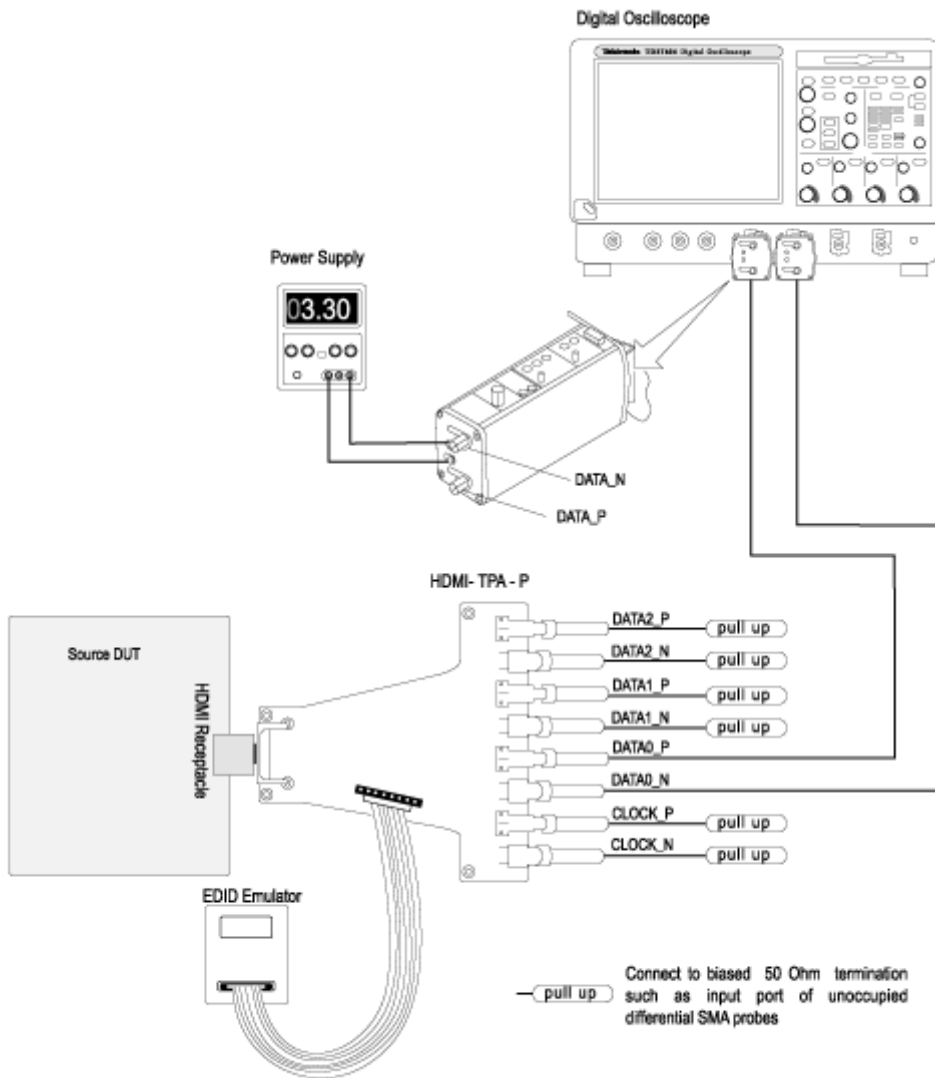

For 4-Channel

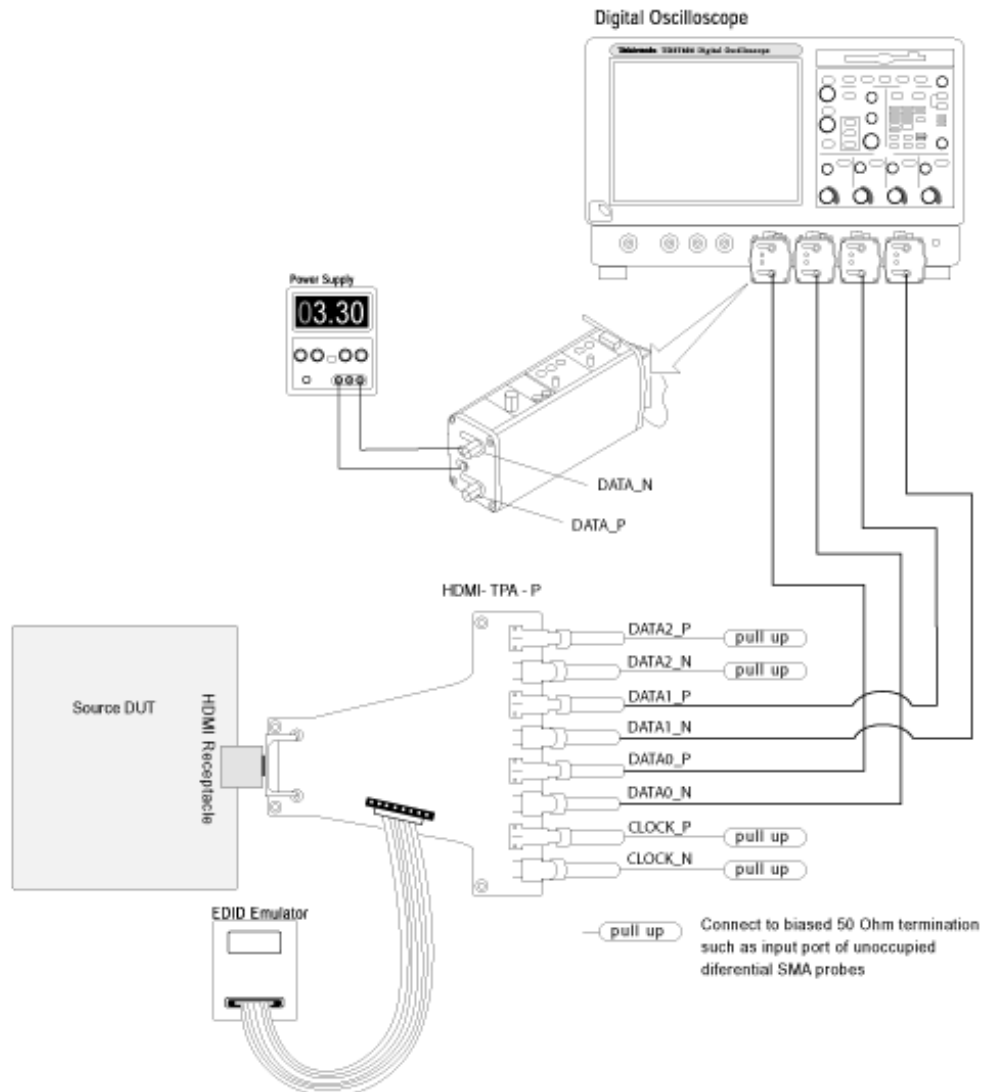

NOTE. *Connecting Ch1 and Ch3 is not a must for this measurement.*

1. Connect the HDMI output of the source DUT to the TPA-P-SE/ET-TPA-P adapter.
2. Connect a power supply to the TPA adapter and set the power supply to 0 V.

NOTE. For the DPO/DSA70000 series oscilloscopes with P7313 SMA probes and Efficere fixtures, you have the option to set the probe control voltage to **internal** from the [Preferences](#) menu. If this option is selected, an external power supply is not required.

3. Connect the EDID emulator to the TPA adapter and set the emulator for the required resolution (refer to the EDID emulator user manual).
4. Connect the first single-ended probe to TMDS_DATA<X>+/ TMDS_CLOCK+.
5. Connect the second single-ended probe to TMDS_DATA<X>-/ TMDS_CLOCK-.
6. Configure the Source DUT to output a video format with the required supported pixel clock frequency.

Min/Max-Diff Swing Tolerance

NOTE. For all the old test fixture connections, connect a TTC filter in between the DTG and the test fixture.

On the menu bar, click **Tests > Connect**.

Method 1: Using old fixtures

Setup 1: To find the minimum swing voltage of the Sink DUT

Make the connection as follows:

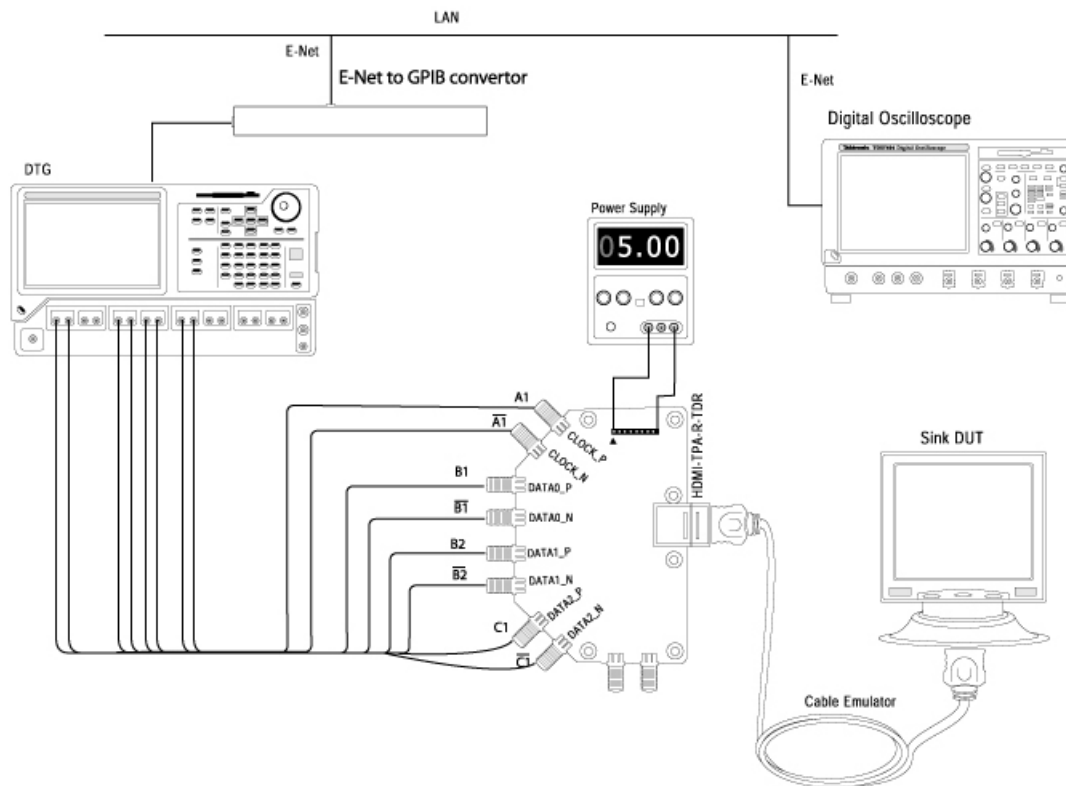

NOTE. Using the Cable Emulator/Cable is not mandatory. You can connect a TPA-P-TDR fixture directly to the DUT. If you find this inconvenient, then use the Cable Emulator/Cable to connect the DUT conveniently.

1. Connect the DTG to the TPA-R-TDR by using eight one meter or one and a half meter SMA cables:
 - Module A, Channel 1+, 1-: Connect to CLOCK_P, and CLOCK_N
 - Module A, Channel 2+, 2-: No Connection
 - Module B, Channel 1+, 1-: Connect to DATA0_P and DATA0_N
 - Module B, Channel 2+, 2-: Connect to DATA1_P and DATA1_N
 - Module C, Channel 1+, 1-: Connect to DATA2_P and DATA2_N
 - Module C, Channel 2+, 2-: No Connection
2. Connect the Cable Emulator from the TPA-R-TDR to the Sink DUT.
3. Connect and configure the DC Power Supply to drive +5 V between +5 V Power (P_5V) and DDC /CEC Ground (P_GND) on the TPA-R-TDR.

Setup 2: To measure the minimum differential swing voltage by using an oscilloscope

Make the connection as follows:

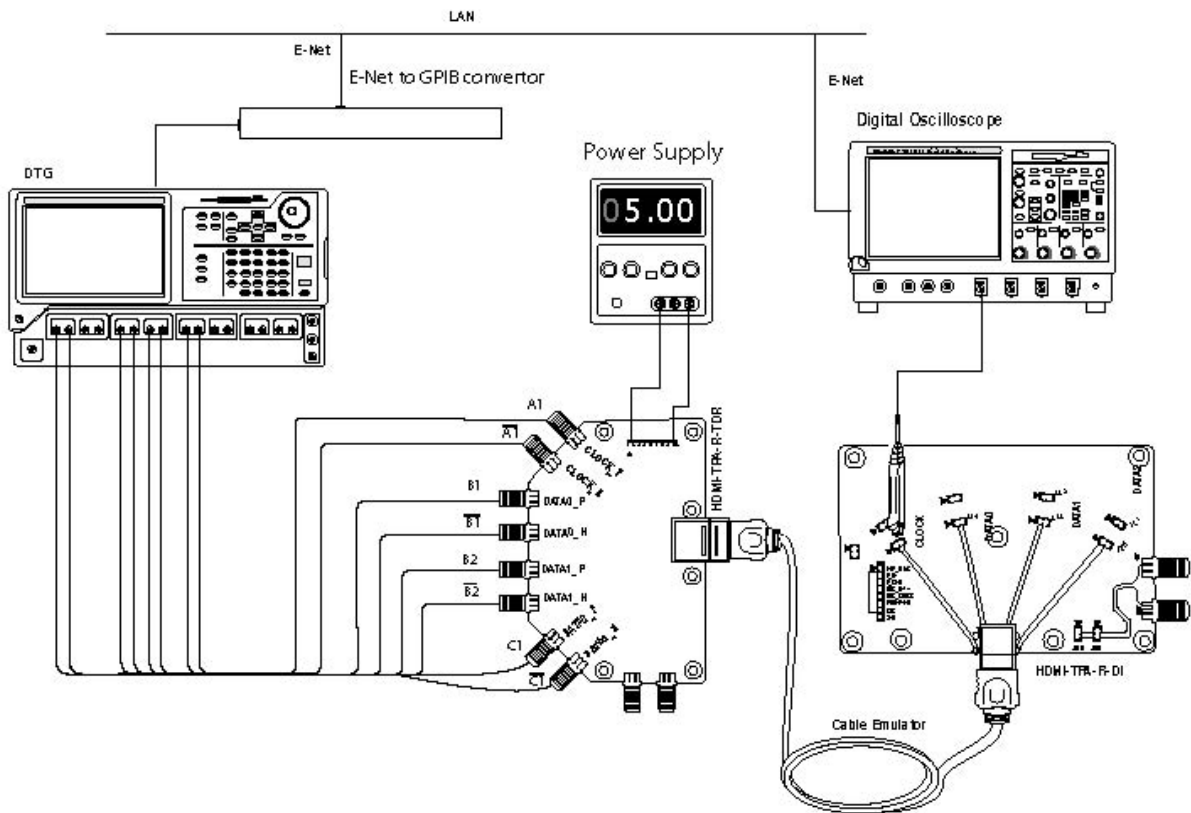

1. Remove the Sink DUT from the Cable Emulator.
2. Connect the TPA-R-DI test fixture at the end of the Cable Emulator.
3. Connect a TMDS Clock/Data channel to the configured oscilloscope channel by using a differential probe.

Setup 3: To find the maximum swing voltage of the Sink DUT

1. Remove the TPA-R-DI test fixture at the end of the Cable Emulator.
2. Connect the Sink DUT to the Cable Emulator.

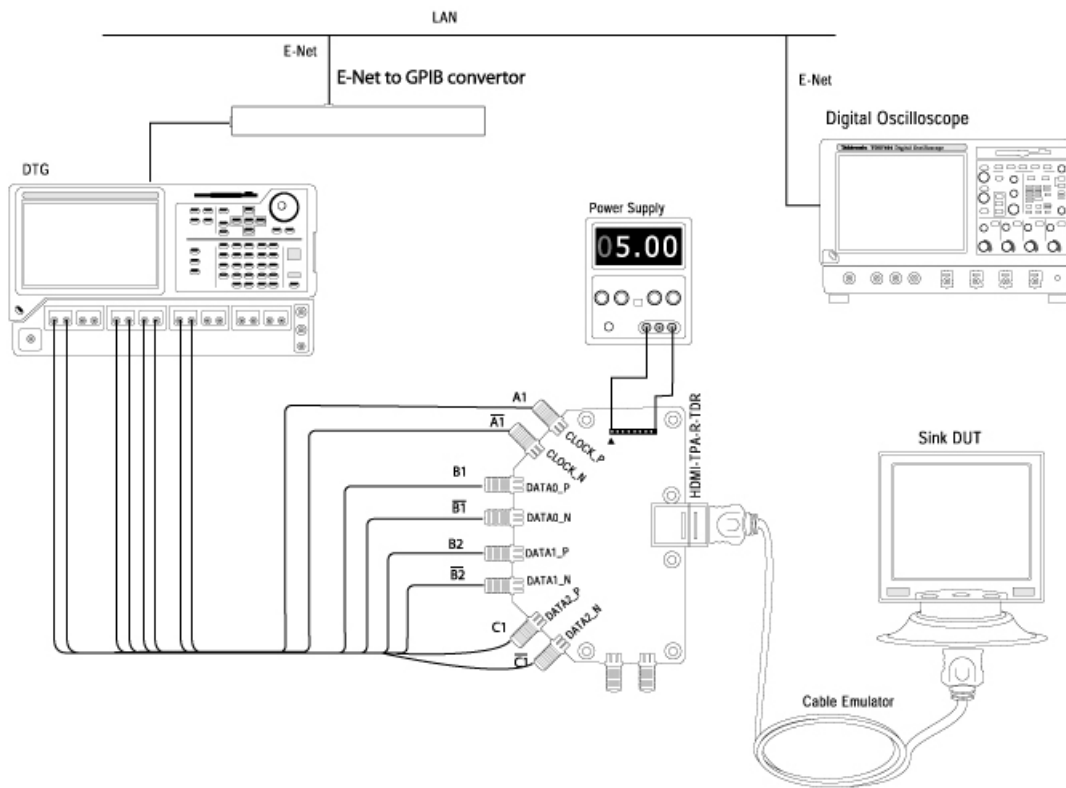

Method 2: Using Efficere test fixtures

Setup 1 : To find the Min/Max differential swing voltage of the Sink DUT with Efficere Test Fixture

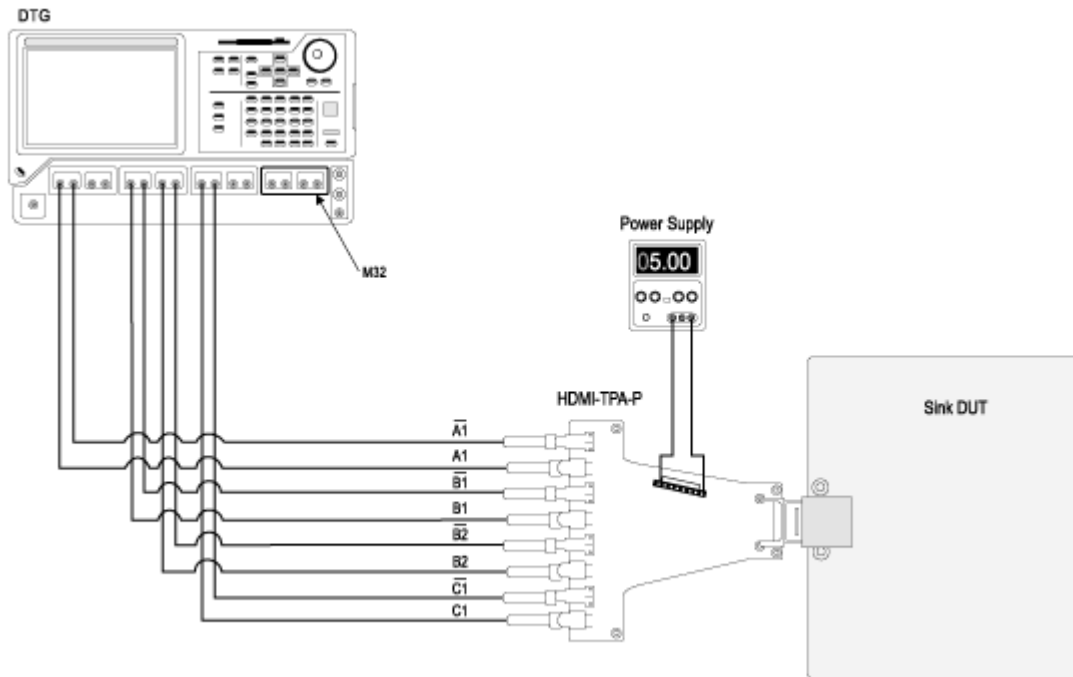

Setup 2 : To measure the Min/Max differential swing voltage of the Sink DUT with Efficere Test Fixture

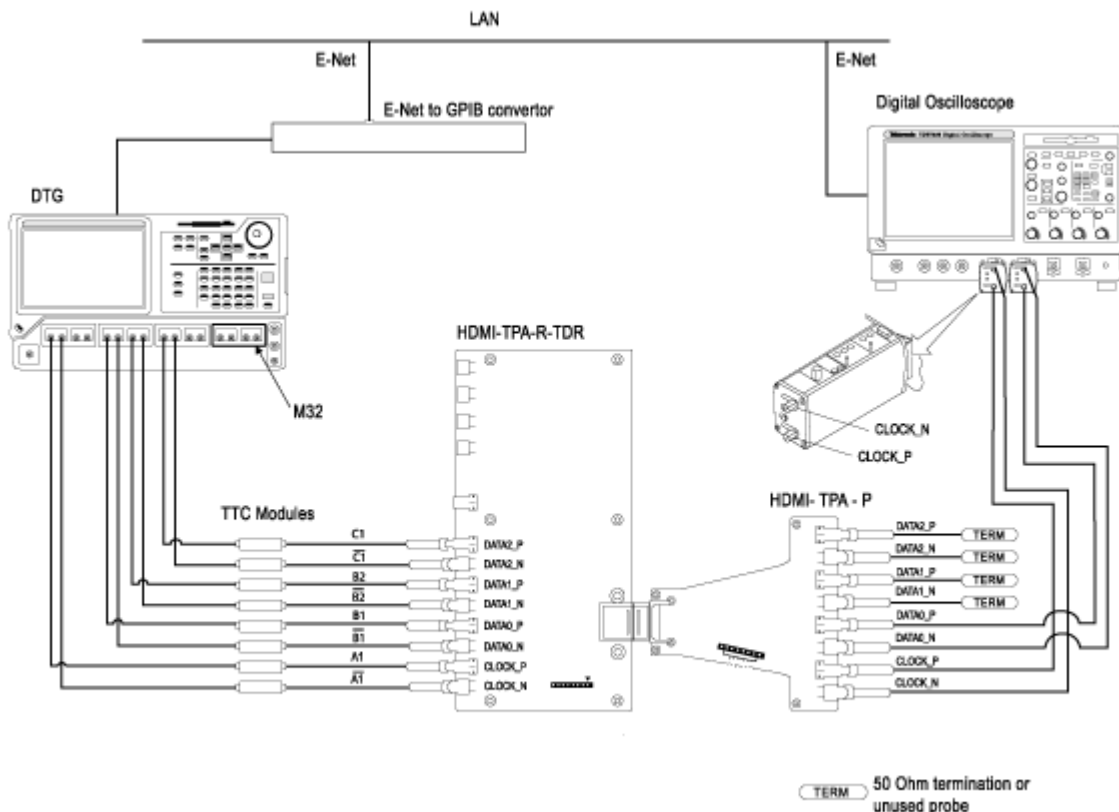

Jitter Tolerance

NOTE. For all the old test fixture connections, connect a TTC filter in between the DTG and the test fixture.

On the menu bar, click **Tests > Connect**.

Method 1: Using old fixtures

Setup 1: To find the device tolerance limit for frequencies < 148.5 MHz make the connections as follows:

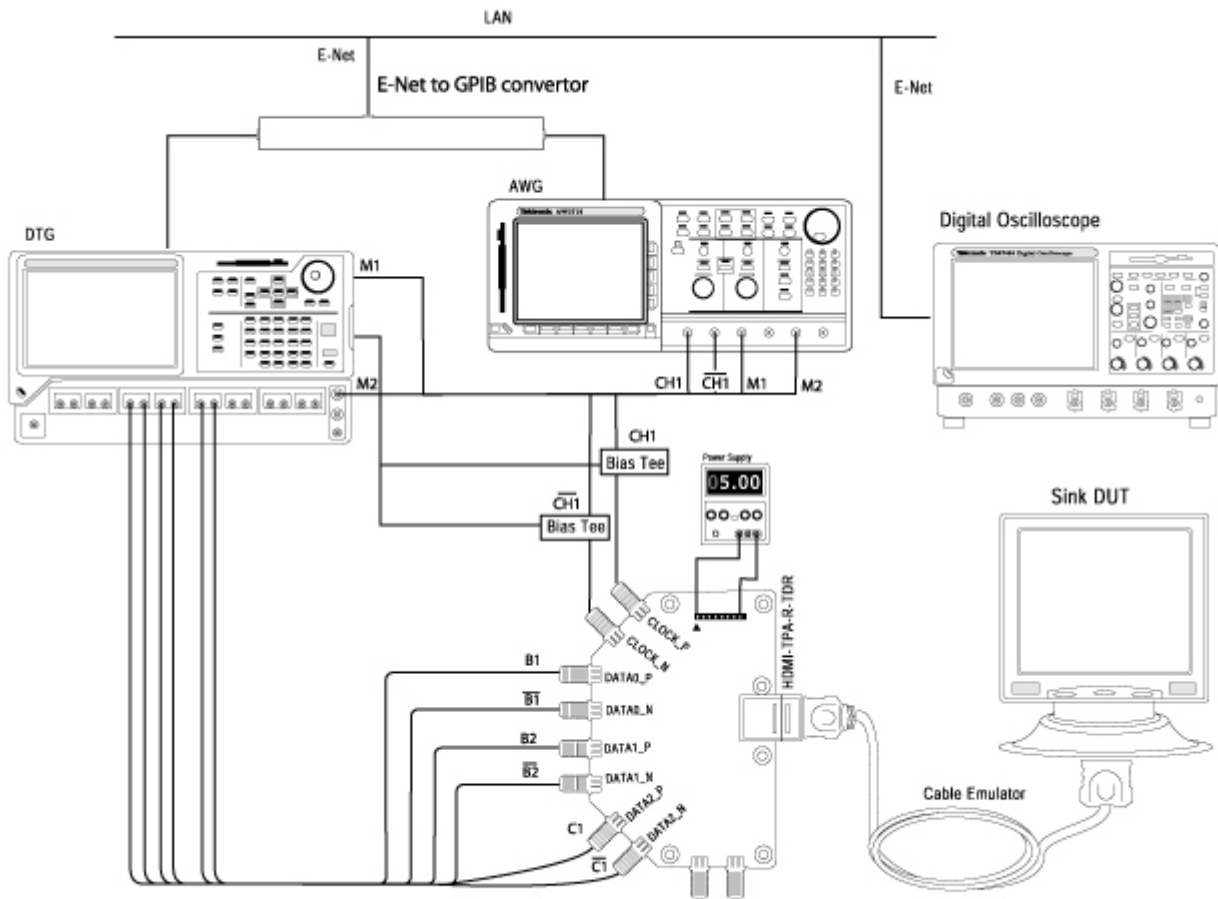

1. Connect the DTG, AWG, Bias-Tees, and the TPA-R-TDR.
 - AWG Marker 1+ output to DTG External Clock input
 - AWG Marker 2+ output to DTG Trigger In
 - AWG Ch. 1+ output to Bias-Tee signal input (RF)
 - Bias-Tee signal output (RF and DC) to CLOCK_P
 - DTG DC_OUT (1) to Bias-Tee DC-level input (DC)
 - AWG Ch. 1- output to Bias-Tee signal input (RF)
 - Bias-Tee signal output (RF and DC) to CLOCK_N
 - DTG DC_OUT (2) to Bias-Tee DC-level input (DC)
 - DTG Module A, Channel 1+, 1-: No Connection
 - DTG Module A, Channel 2+, 2-: No Connection
 - DTG Module B, Channel 1+, 1-: Connect to DATA0_P and DATA0_N
 - DTG Module B, Channel 2+, 2-: Connect to DATA1_P and DATA1_N
 - DTG Module C, Channel 1+, 1-: Connect to DATA2_P and DATA2_N
 - DTG Module C, Channel 2+, 2-: No Connection
2. Connect the TPA-R-TDR to the Sink DUT by using a Cable Emulator specified for tested pixel clock rate.
3. Connect and configure the DC Power Supply to drive +5 V between +5 V Power (P_5V) and DDC/CEC Ground (P_GND) on the TPA-R-TDR.

Setup 2: To measure the parameters for frequencies < 148.5 MHz make the connections as follows:

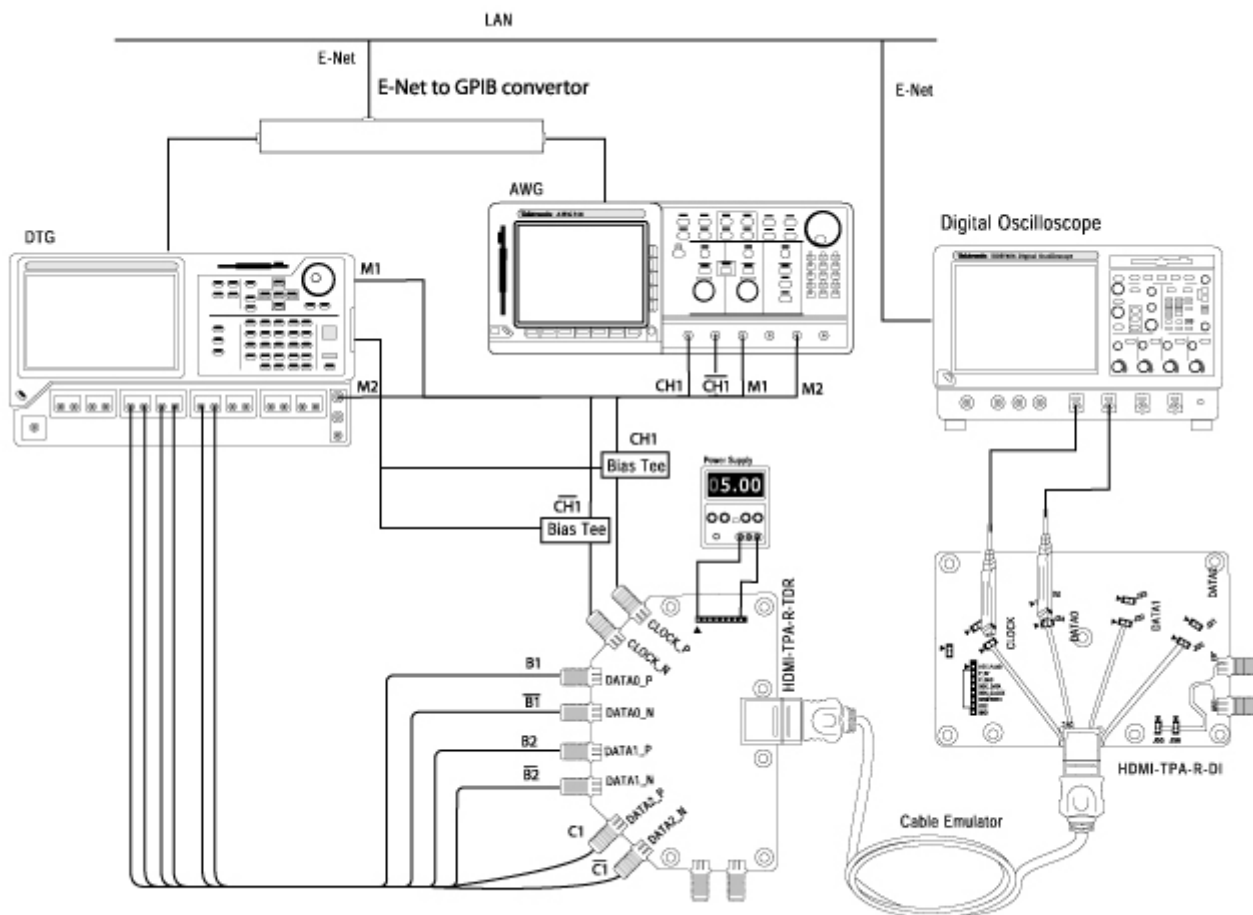

1. Remove the Sink DUT.
2. Connect the TPA-R-DI test adaptor to a Cable Emulator.
3. Connect a Clock to the configured oscilloscope channel by using a differential probe.
4. Connect the DATA pair on which you will conduct the test to the configured oscilloscope channel by using a second differential probe.

Method 2: Using Efficere test fixtures

Connections for jitter calibration (common to all jitter insertion setups)

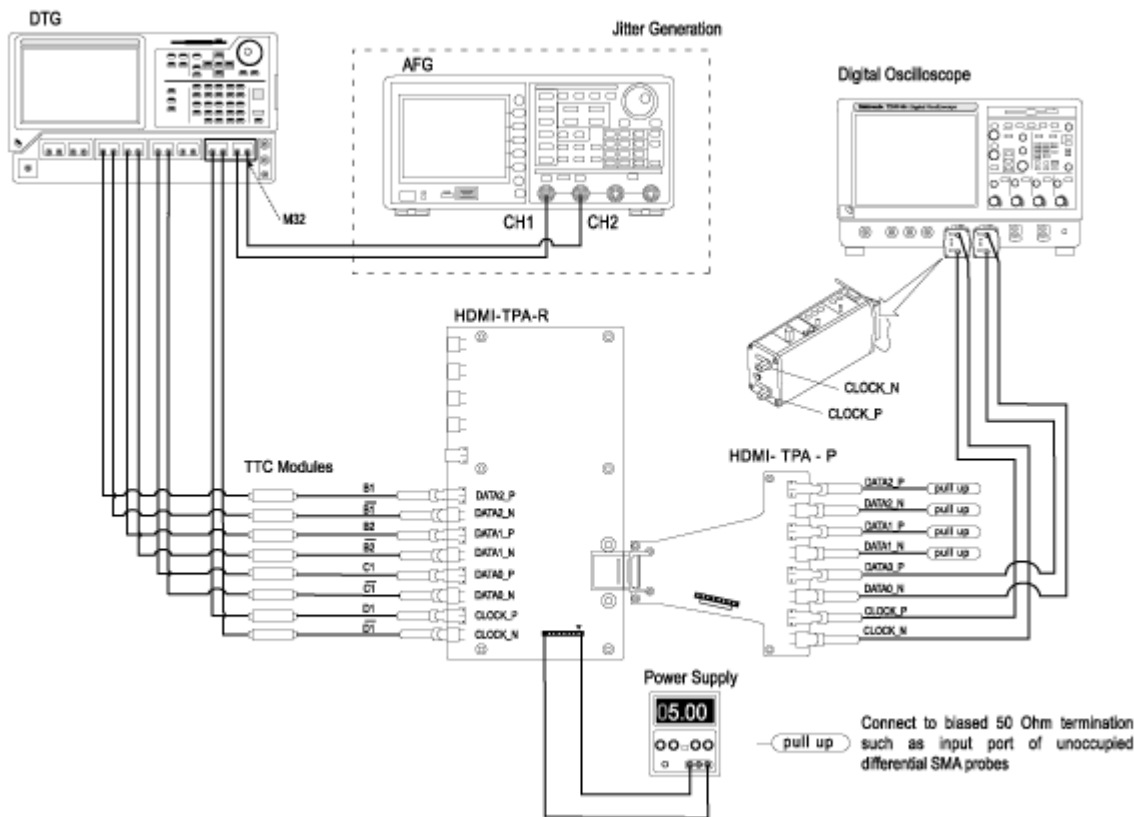

1. Use Jitter Generation block to generate a known amount of jitter (Clock jitter: 0.25 UI, Data jitter: 0.30 UI).
2. Connect the test fixture to the oscilloscope for calibration. The oscilloscope calculates data and clock jitter inserted due to the cables and the test fixtures along with the known amount of jitter.

Connections to adjust the clock jitter at TP2

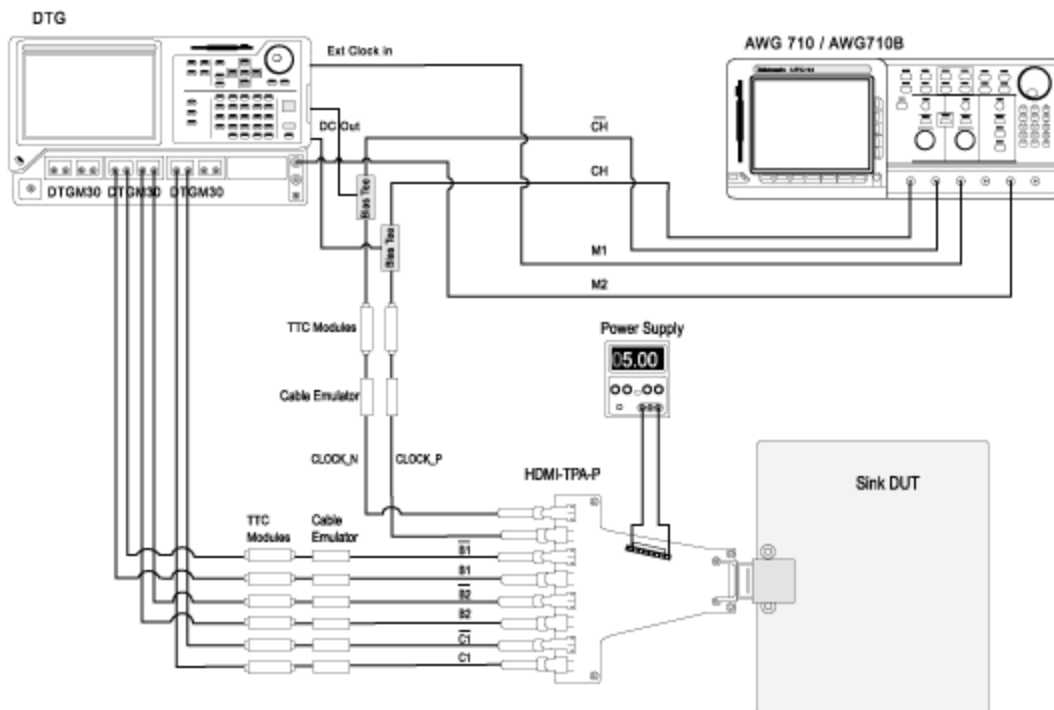

1. Connect the test equipment for DTG and AWG connection as shown in the setup diagram.
2. When connecting the test fixture to the DUT, use a cable emulator specified for the pixel clock rate being tested.
3. Connect the DTG, AWG, and the oscilloscope according to the [Enable Remote Control of Test Equipment](#) procedure.
4. Configure the DUT to receive the HDMI input signal.

Setup 1b: DTG-AWG710/AWG710B for testing resolutions > 74.25MHz

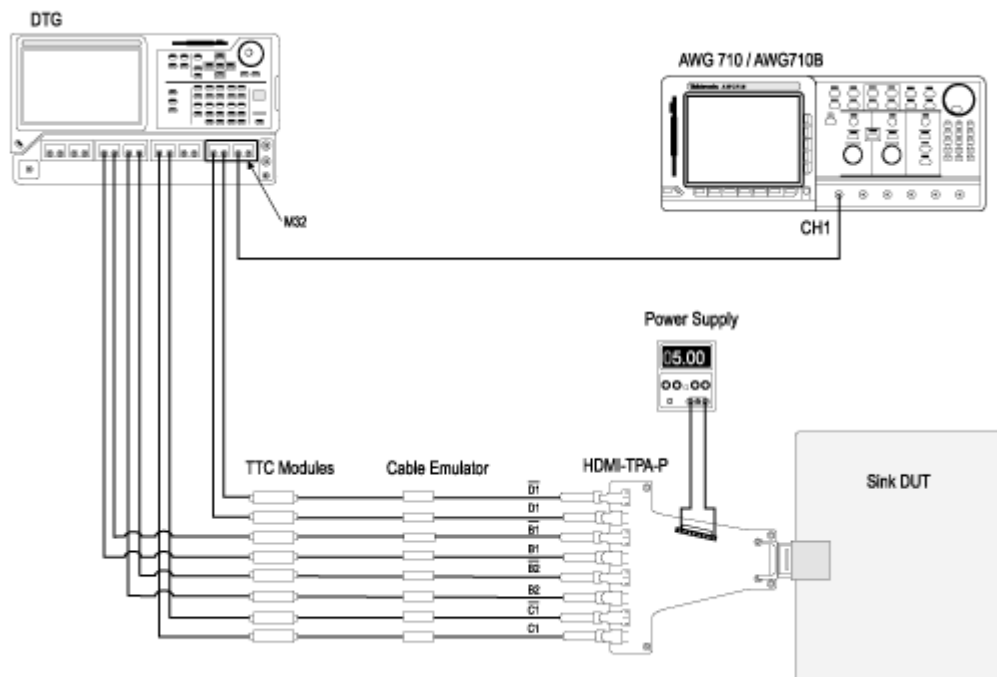

1. Connect the test equipment for DTG and AWG connection as shown in the setup diagram.
2. Connect the DTG, AWG, and the oscilloscope according to the Enable Remote Control of Test Equipment procedure.
3. Configure the DUT to receive the HDMI input signal.

NOTE. Some of the DUTs work with test fixtures that are not connected to a power supply.

Setup 2: DTG-AFG3000 jitter tolerance

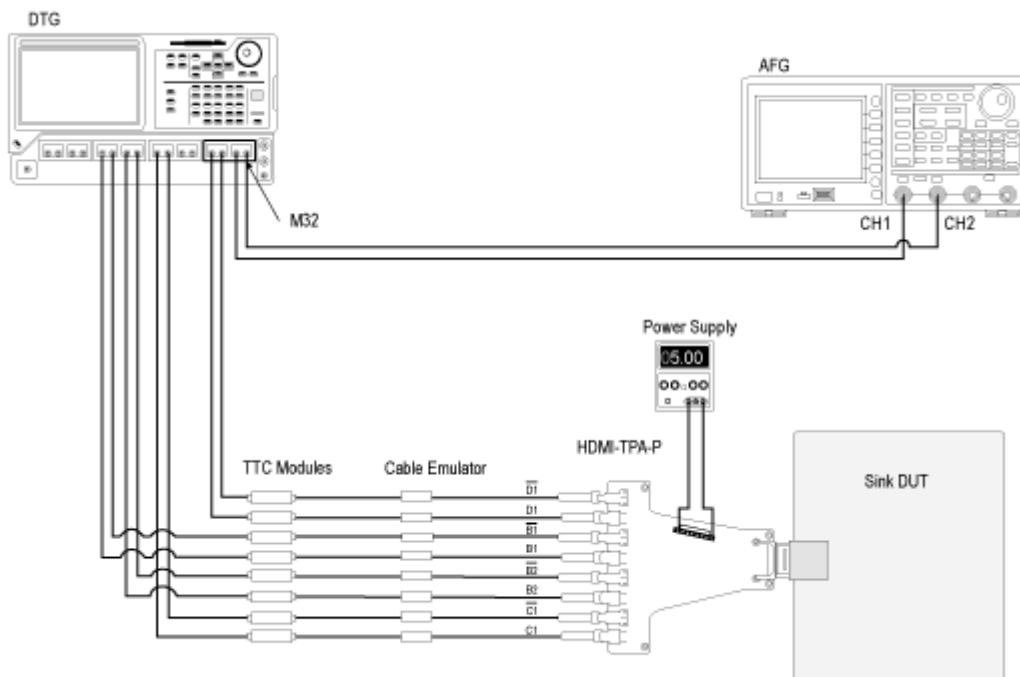

1. Connect the test equipment for DTG and AFG connection as shown in the setup diagram.
2. When connecting the test fixture to the DUT, use a cable emulator specified for the pixel clock rate being tested.
3. Connect the DTG, AFG, and the oscilloscope according to the Enable Remote Control of Test Equipment procedure.
4. Configure the DUT to receive the HDMI input signal.

Setup 3: DTG-AWG7102 composite jitter tolerance for all frequencies

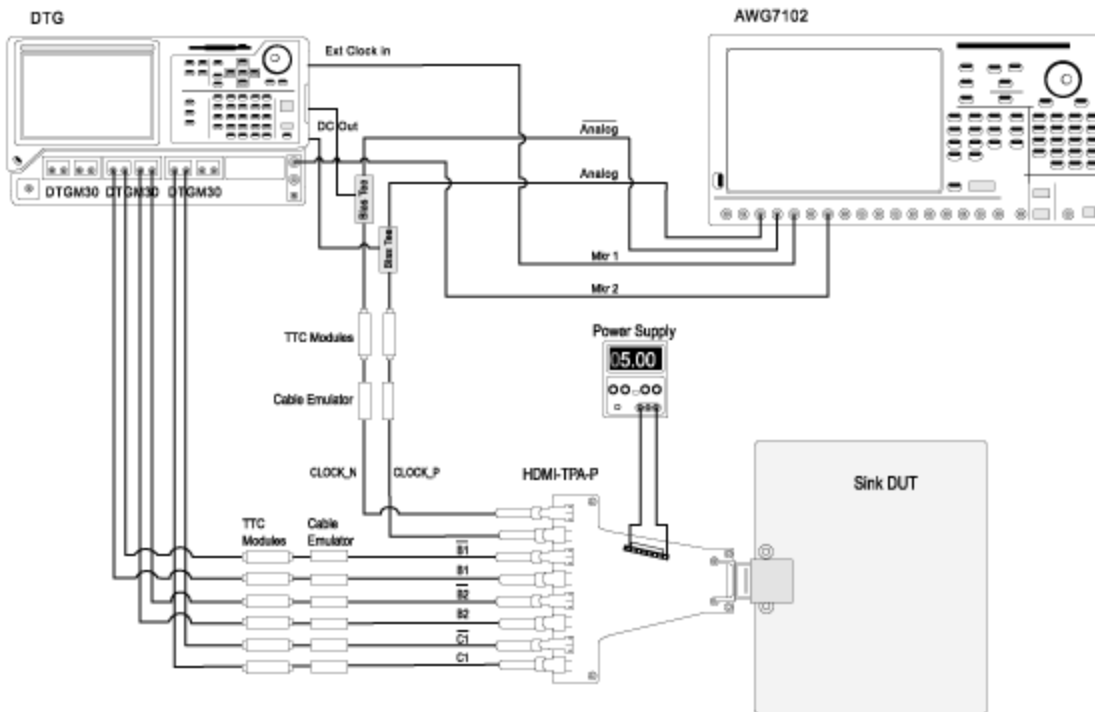

1. Connect the test equipment for DTG and AWG7102 connection as shown in the setup diagram.
2. When connecting the test fixture to the DUT, use a cable emulator specified for the pixel clock rate being tested.
3. Connect the DTG, AWG7102, and the oscilloscope according to the Enable Remote Control of Test Equipment procedure.
4. Configure the DUT to receive the HDMI input signal.

NOTE. *Mkr2 need not be connected to the trigger input of the DTG.*

Setup 4: DTG-AWG7102 separate jitter tolerance for all frequencies

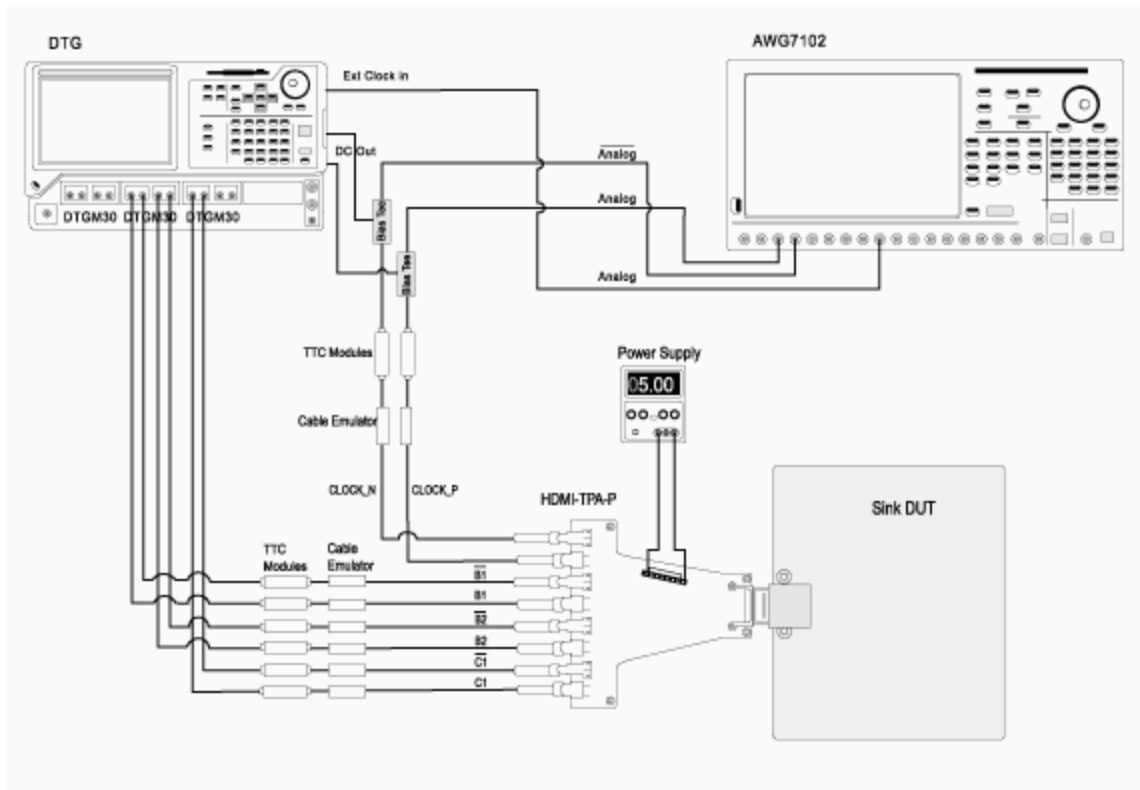

1. Connect the test equipment for DTG and AWG7102 connection as shown in the setup diagram.
2. When connecting the test fixture to the DUT, use a cable emulator specified for the pixel clock rate being tested.
3. Connect the DTG, AWG7102, and the oscilloscope according to the Enable Remote Control of Test Equipment procedure.
4. Configure the DUT to receive the HDMI input signal.

Intra-Pair Skew (Sink)

NOTE. For all the old test fixture connections, connect a TTC filter in between the DTG and the test fixture.

On the menu bar, click **Tests > Connect**.

NOTE. The procedure mentioned next is for the clock intra-pair skew test. For other pairs, interchange the connection of DATA <X> _P with CLOCK_P and DATA <X> _N with CLOCK_N. Make the appropriate changes in the configuration of the DTG Outputs accordingly.

For example, to calculate the intra-pair skew of Data0:

Connect DATA0_P to Module A1+, DATA0_N to DTG Module A2+, CLOCK_P to Module B1+, and CLOCK_N to module B1-.

Method 1: Using old fixtures

Setup 1: To measure Tbit

Make the connection as follows:

NOTE. Use channel **A1** of the DTG instead of channel A2 (shown in figure) to make connections for Tbit measurements.

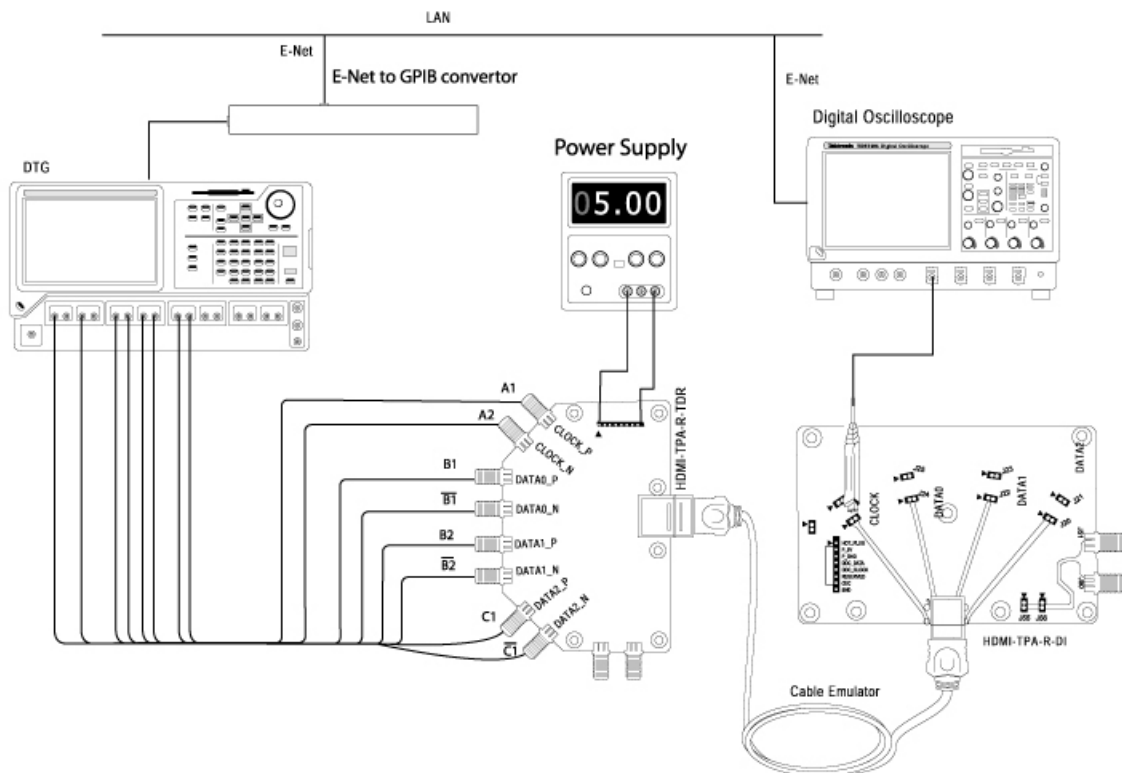

NOTE. *Using the Cable Emulator/Cable is not mandatory. You can connect a TPA-P-TDR fixture directly to the DUT. If you find this inconvenient, then use the Cable Emulator/Cable to connect the DUT conveniently.*

1. Connect the DTG to the TPA-R-TDR by using eight one meter (preferable) or one and a half meter SMA cables:
 - Module A, Channel 1+: Connect to CLOCK_P
 - Module A, Channel 1-: No Connection
 - Module A, Channel 2+: Connect to CLOCK_N
 - Module A, Channel 2-: No Connection
 - Module B, Channel 1+, 1-: Connect to DATA0_P and DATA0_N
 - Module B, Channel 2+, 2-: Connect to DATA1_P and DATA1_N
 - Module C, Channel 1+, 1-: Connect to DATA1_P and DATA1_N
 - Module C, Channel 2+, 2-: No Connection
2. Connect the TPA-R-TDR to the Cable Emulator.
3. Connect the TPA-R-DI to the Cable Emulator.
4. Connect a Clock to the configured oscilloscope channel by using a differential probe.

Setup 2: To find intra-pair skew of the Sink DUT

Make the connection as follows:

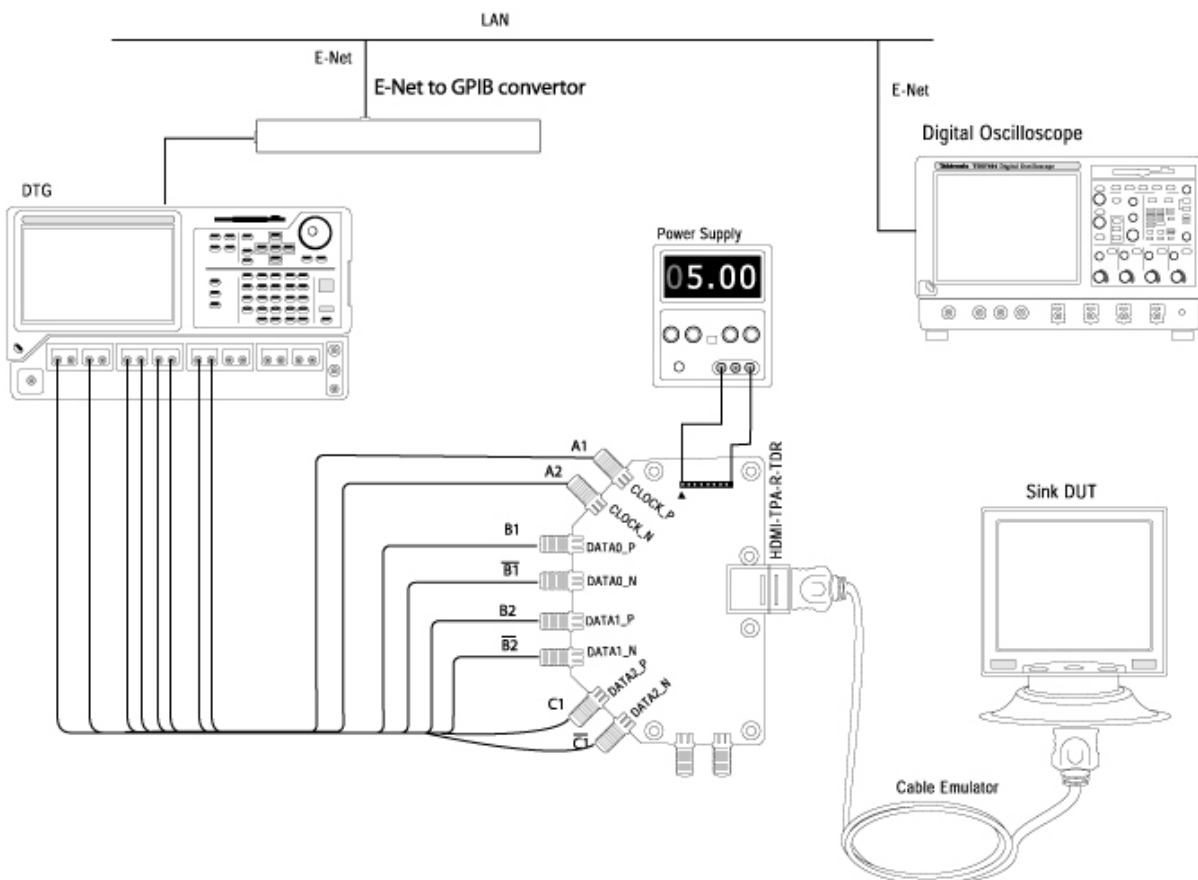

NOTE. Using the Cable Emulator/Cable is not mandatory. You can connect a TPA-P-TDR fixture directly to the DUT. If you find this inconvenient, then use the Cable Emulator/Cable to connect the DUT conveniently.

1. Remove the TPA-R-DI test fixture from the Cable Emulator.
2. Connect the Sink DUT to the Cable Emulator.
3. Connect and configure the DC Power Supply to drive +5 V between +5 V Power (P_5V) and DDC/CEC Ground (P_GND) on the TPA-R-TDR.

Method 2: Using Efficere test fixtures

Setup 1: To find intra-pair skew of the Sink DUT with Efficere Test Fixture

Make the connections as follows:

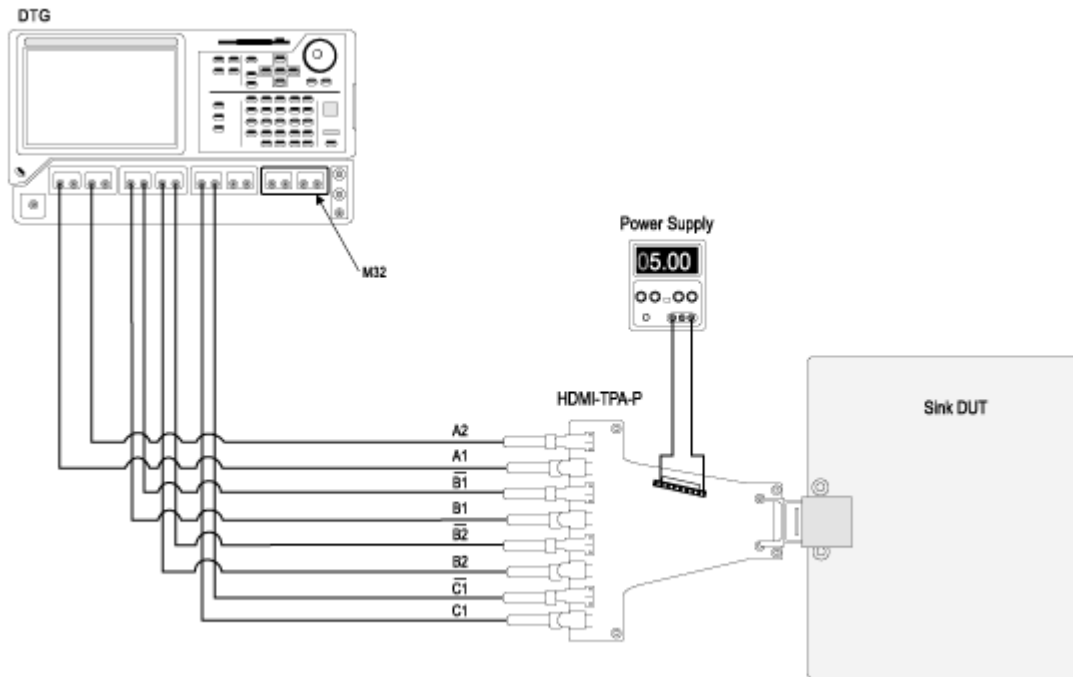

Eye Diagram (Cable)

On the menu bar, click **Tests > Connect**.

Setup diagram for TP1

Make the connection as follows:

Method 1: Using old fixtures

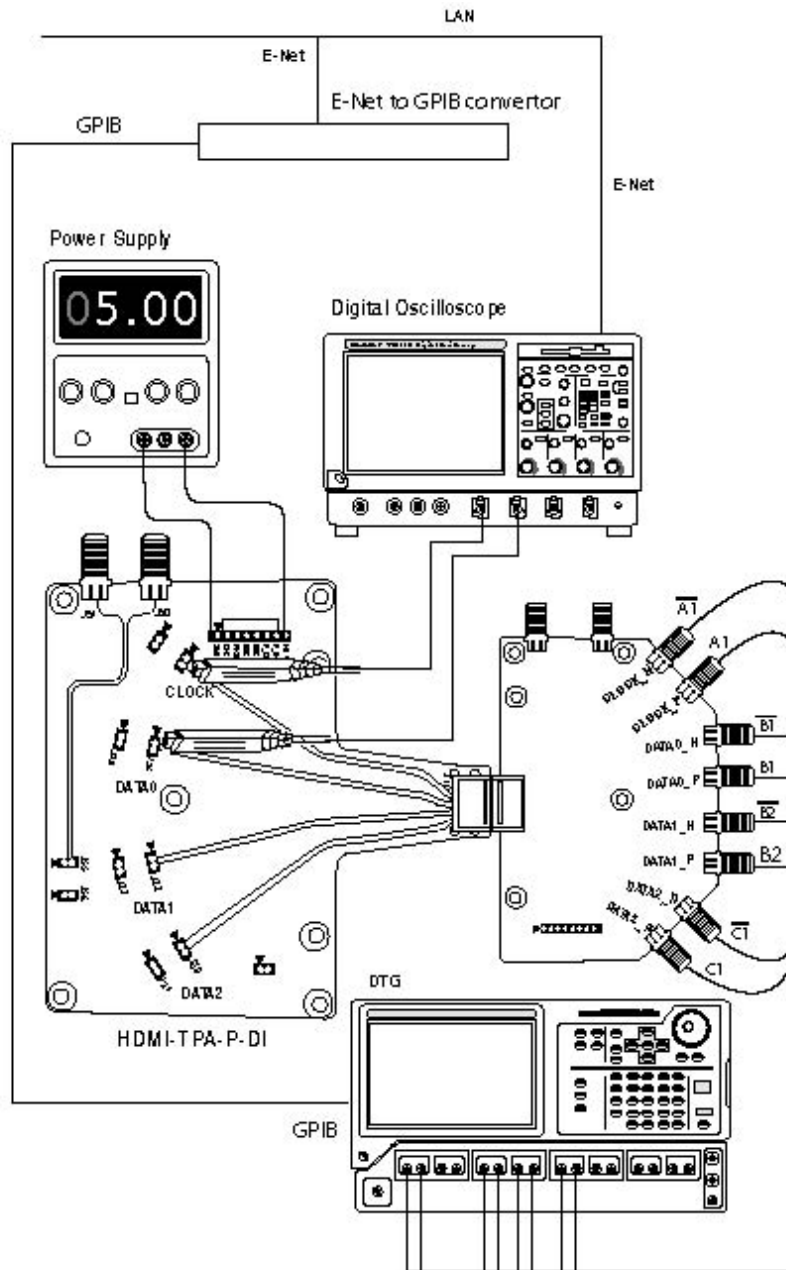

Method 2: Using Efficere test fixtures

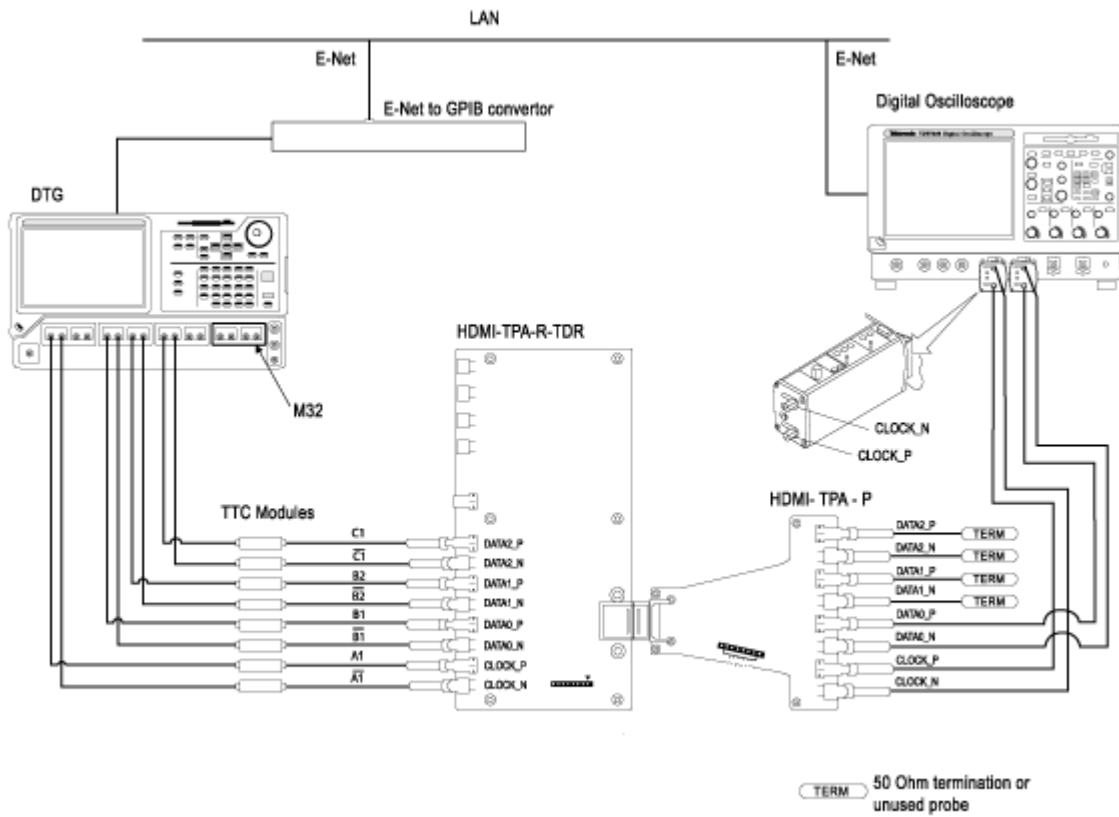

For 4-Channel

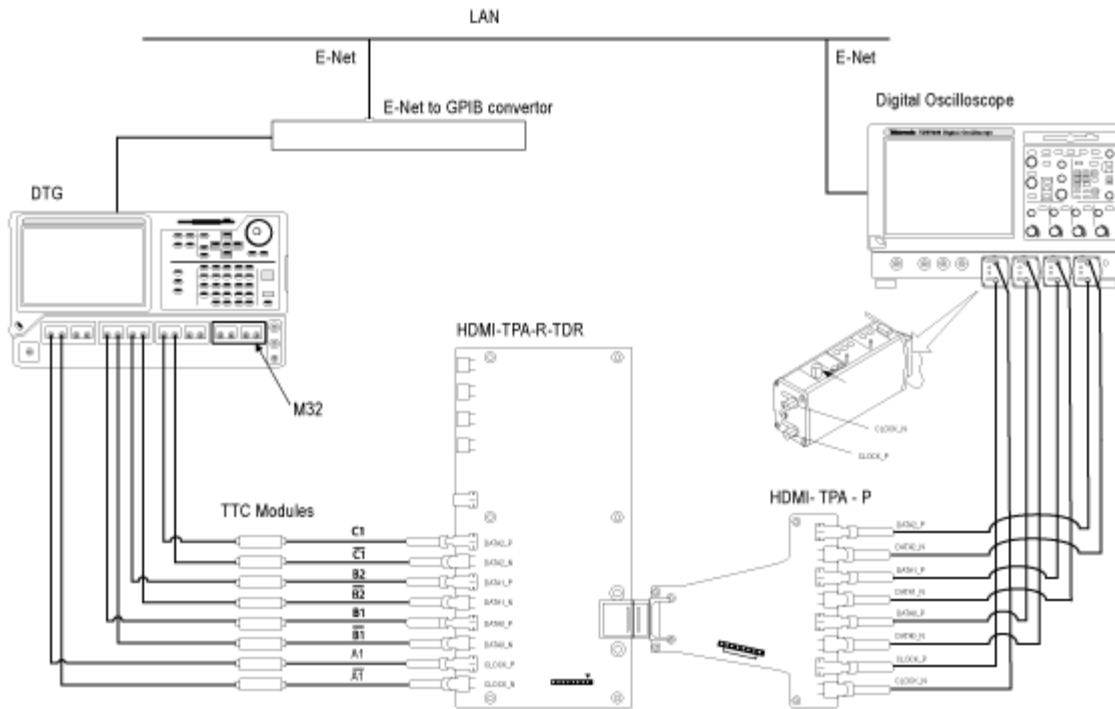

For 4-Channel with AFG Jitter Insertion

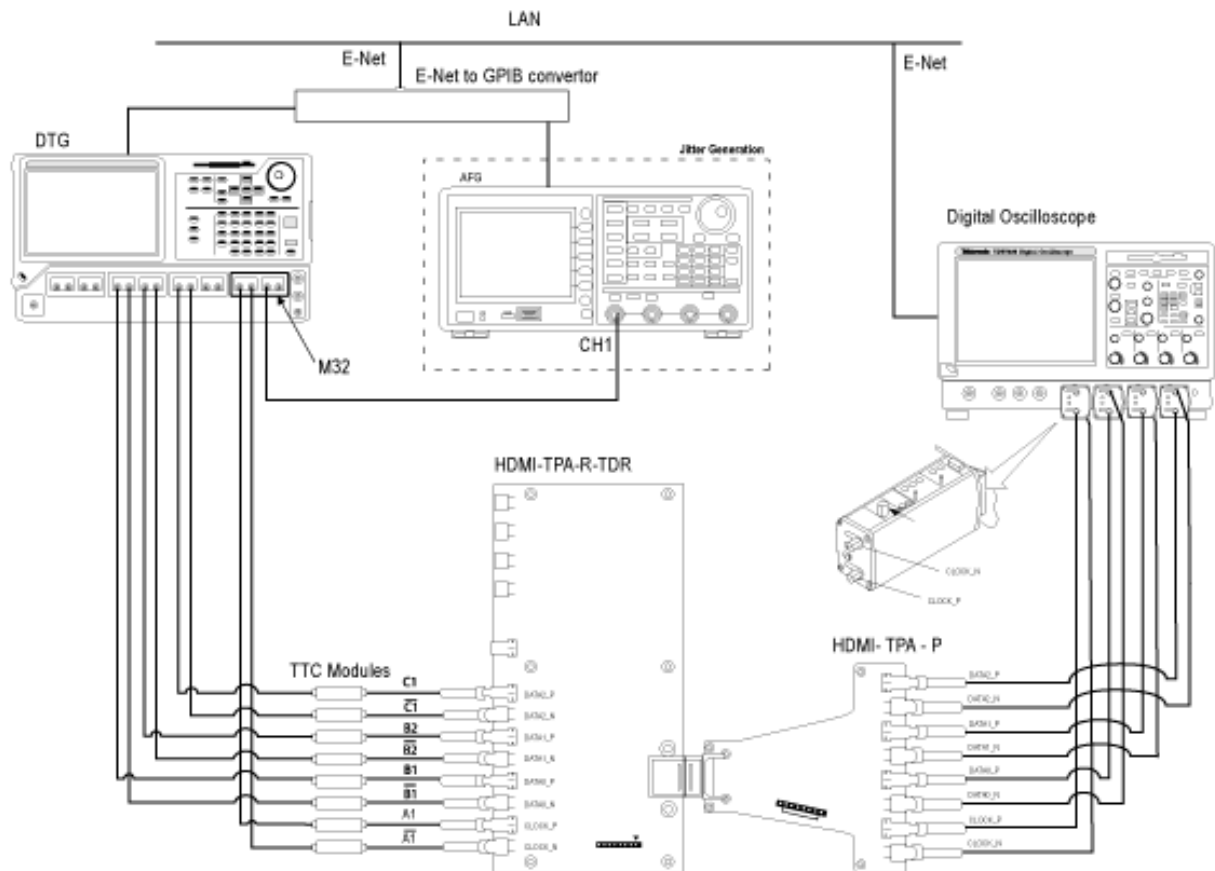

1. Connect the DTG to the “input” TPA-P-TDR/ET-TPA-P adapter by using eight one meter (preferable) or one and a half meter SMA cables:
 - Module A, Channel 1+, 1-: Connect to CLOCK_P and CLOCK_N
 - Module A, Channel 2+, 2-: No Connection
 - Module B, Channel 1+, 1-: Connect to DATA0_P and DATA0_N
 - Module B, Channel 2+, 2-: Connect to DATA1_P and DATA1_N
 - Module C, Channel 1+, 1-: Connect to DATA2_P and DATA2_N
 - Module C, Channel 2+, 2-: No Connection
2. Connect the oscilloscope to the “output” TPA-R-DI adapter by using two/four differential probes, and supply 3.3 V power.

3. Connect a TMD5 CLOCK to the configured oscilloscope channel by using a differential probe.
4. Connect the TMD5_DATA pair(s) on which you will conduct the test to the configured oscilloscope channel by using a second differential probe(s).

Setup diagram for TP2

Make the connection as follows:

Method 1: Using old fixtures

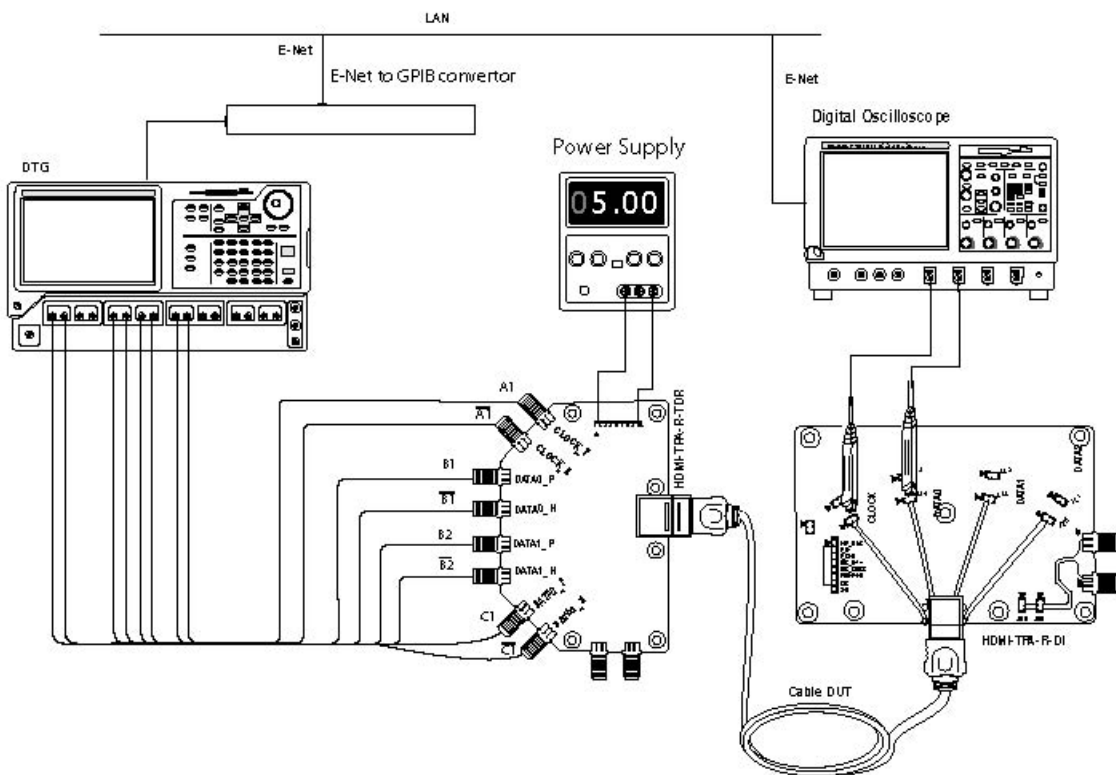

Method 2: Using Efficere test fixtures

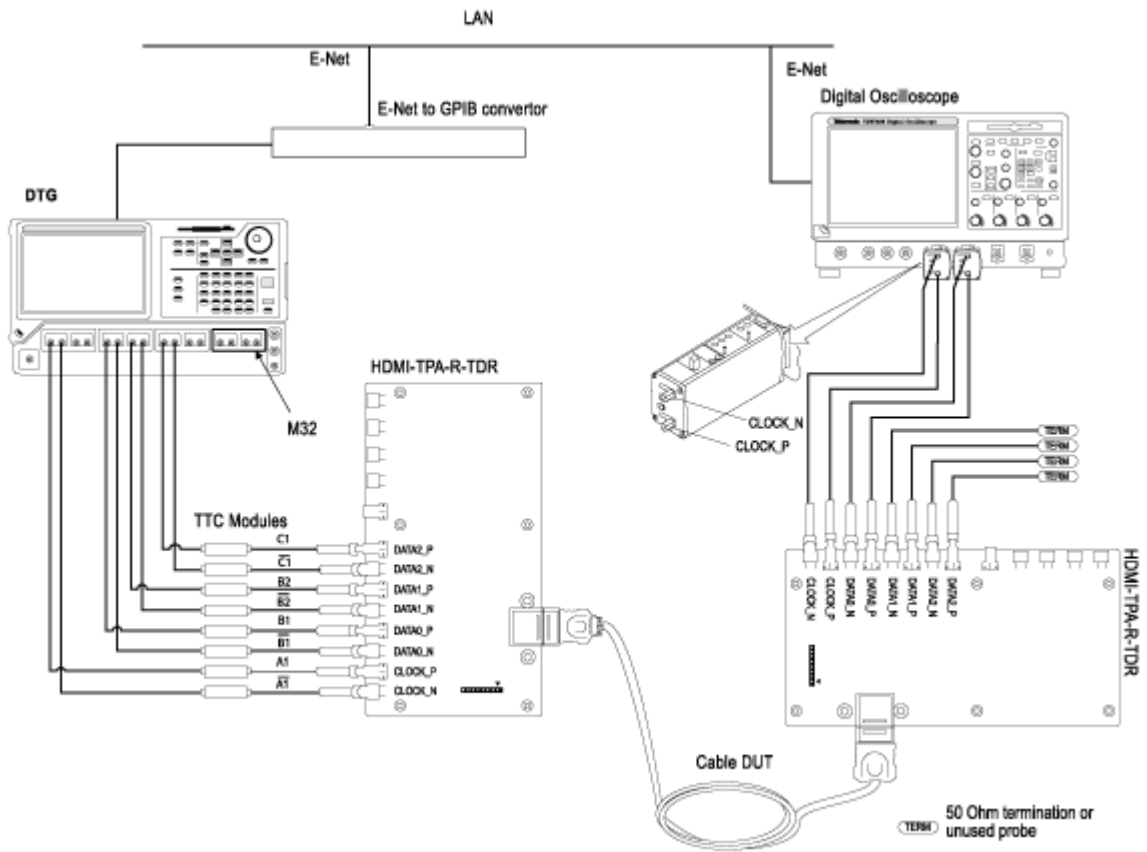

For 4-Channel

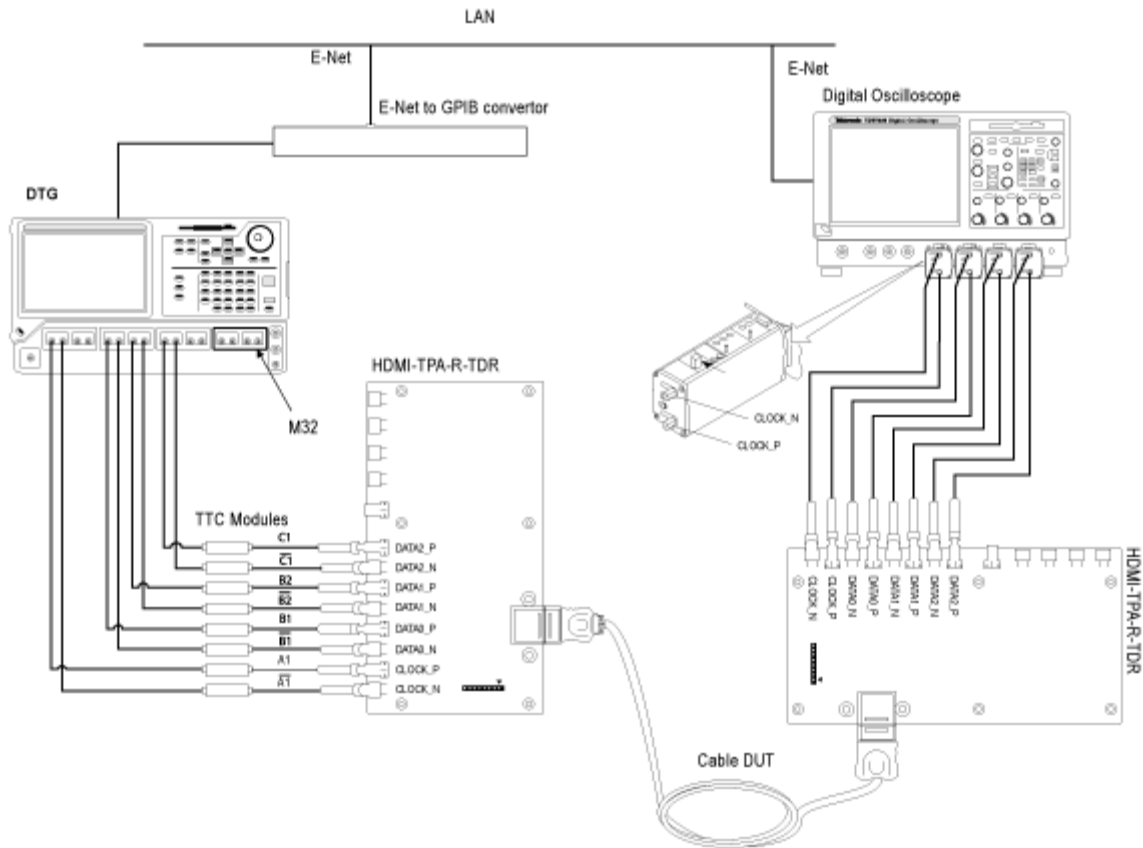

For 4-Channel with AFG Jitter Insertion

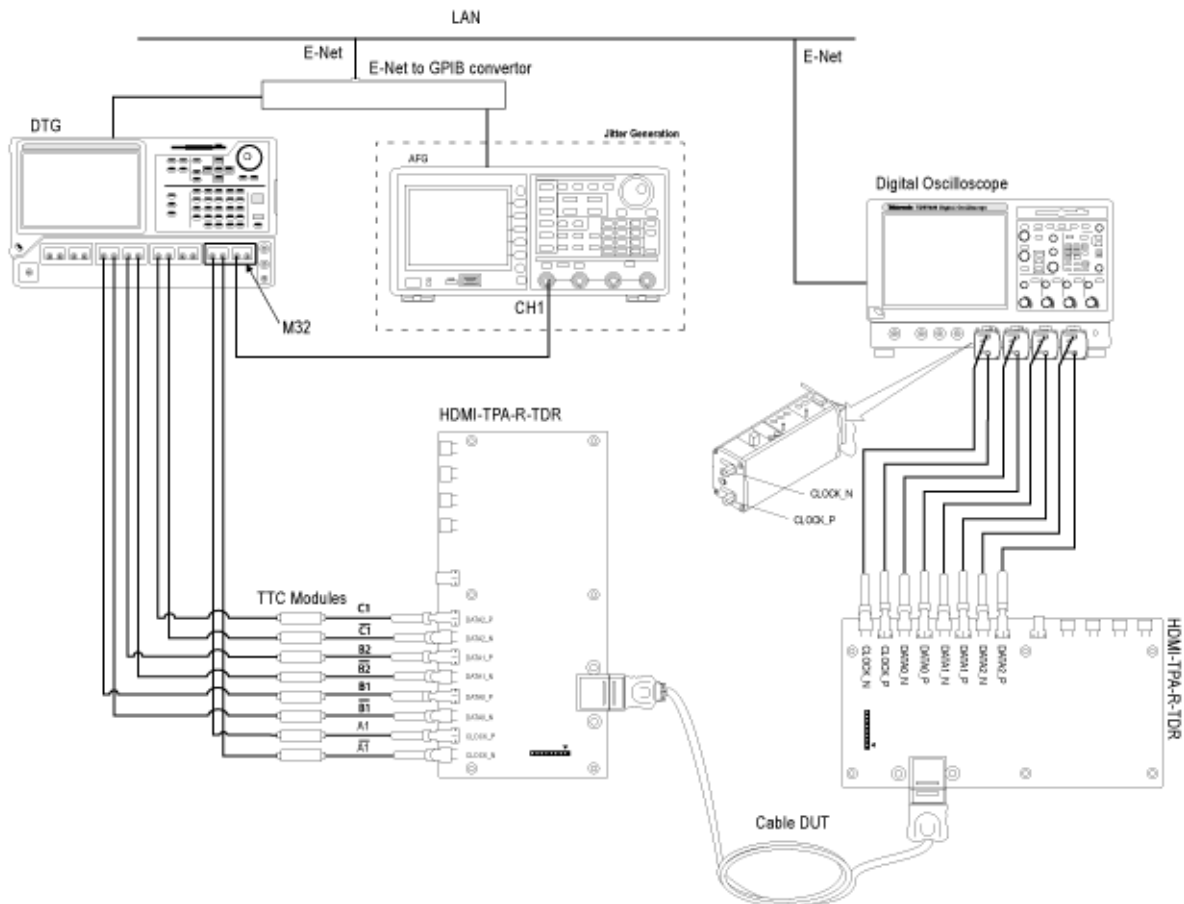

1. Remove the TPA-P-DI/ET-TPA-P test adaptor.
2. Connect the Cable DUT.
3. Connect the TPA-R-DI test adaptor.
4. Connect a TMDS CLOCK to the configured oscilloscope channel by using a differential probe.
5. Connect the TMDS_DATA pair(s) on which you will conduct the test to the configured oscilloscope channel by using a second differential probe(s).

Eye Diagram (Source)

Click **View Waveform** to display the input signals Clock and Data as follows:

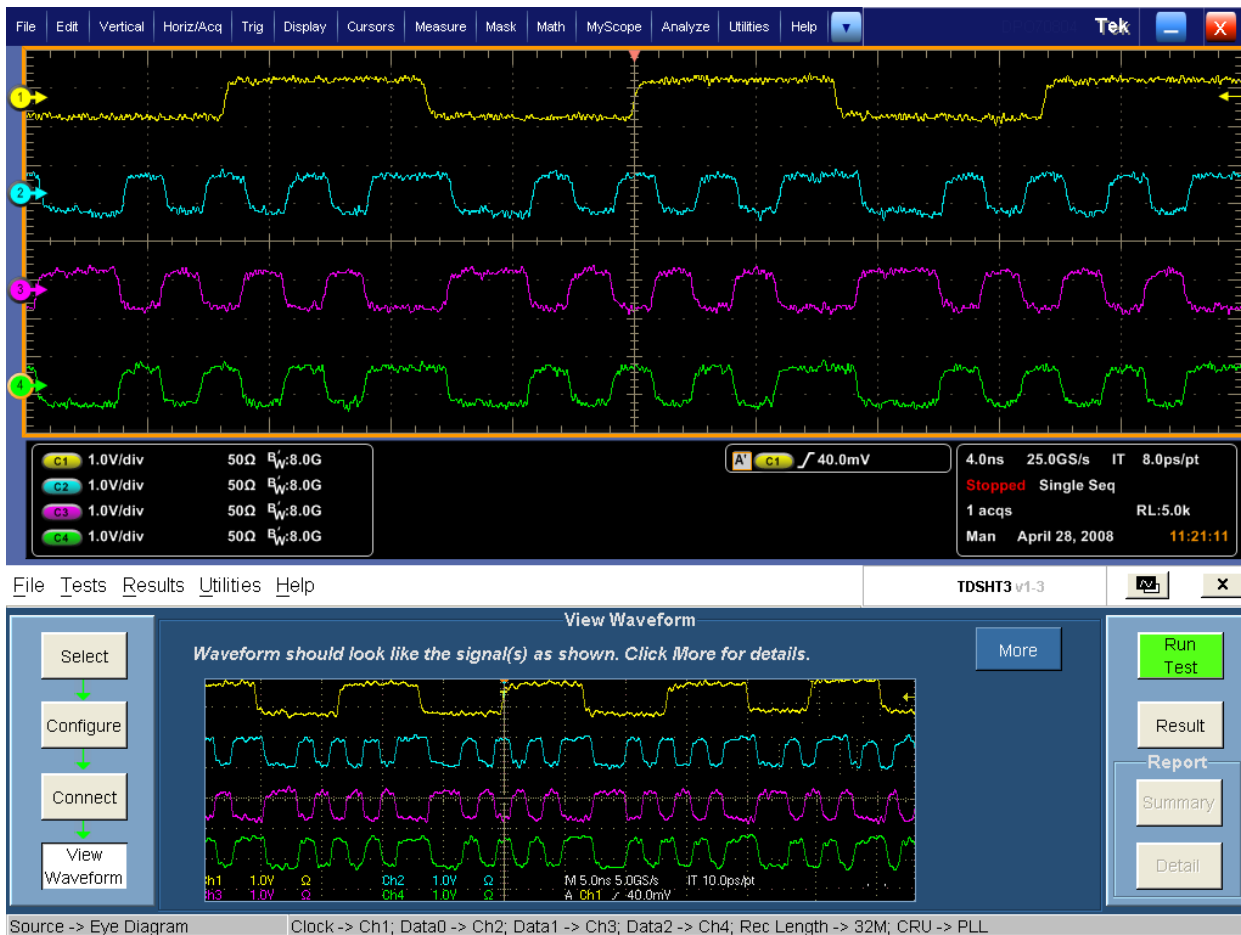

Duty Cycle

Click **View Waveform** to display the Clock signal as follows:

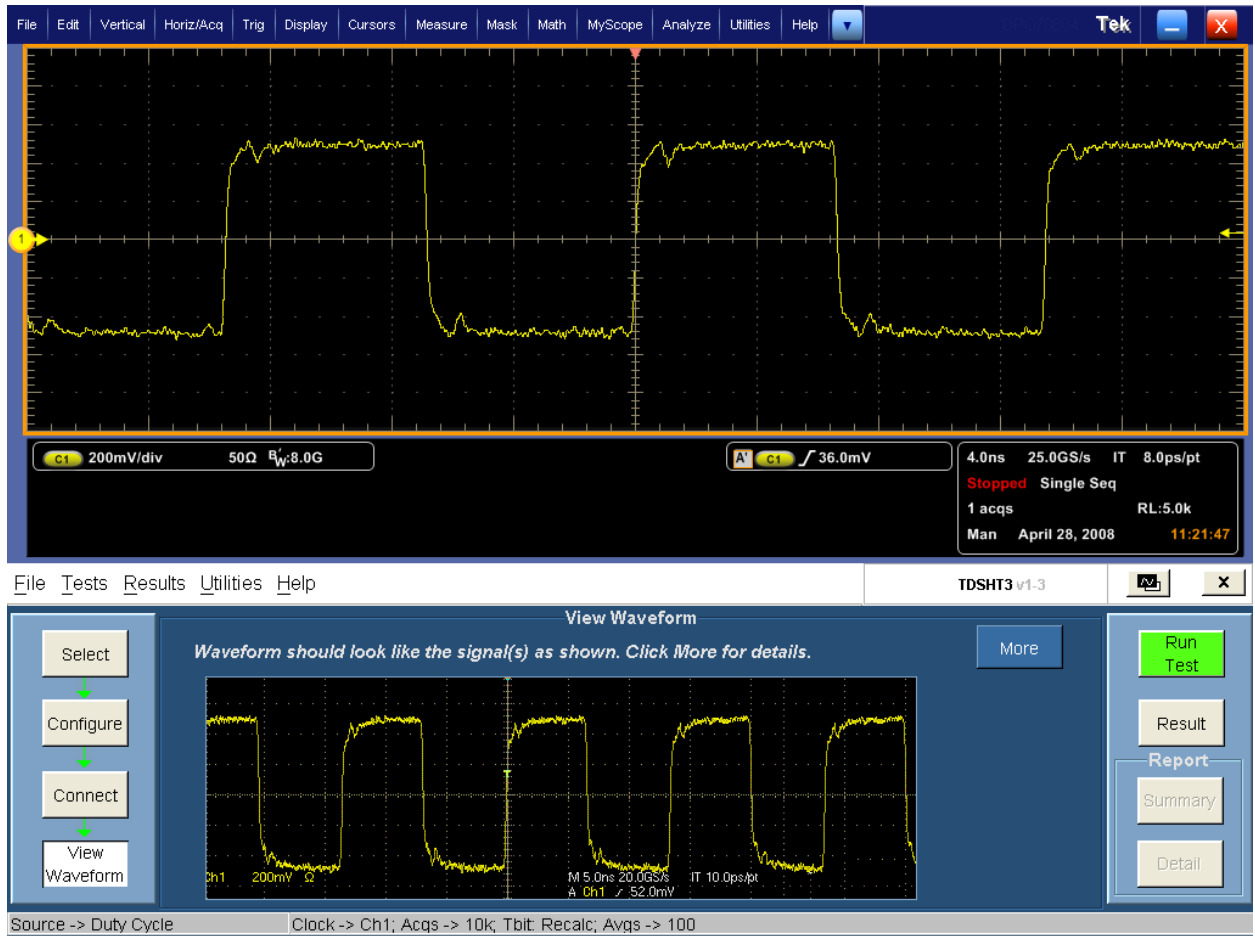

Rise Time

Click **View Waveform** to display the input signals Clock or Data as follows:

The screenshot displays the Tektronix TDSHT3 v1.3 software interface. The main window shows a waveform viewer with four channels (C1, C2, C3, C4) plotted on a grid. The channels are color-coded: C1 (yellow), C2 (cyan), C3 (magenta), and C4 (green). The waveform shows a clock signal (C1) and three data signals (C2, C3, C4) with varying rise times. The interface includes a menu bar (File, Edit, Vertical, Horiz/Acq, Trig, Display, Cursors, Measure, Mask, Math, MyScope, Analyze, Utilities, Help) and a status bar (4.0ns, 25.0GS/s, IT 8.0ps/pt, Stopped, Single Seq, 1 acqs, RL:5.0k, Man April 28, 2008, 11:22:36). Below the main window, there is a 'View Waveform' dialog box with a 'Select' button, a 'Configure' button, a 'Connect' button, and a 'View Waveform' button. The dialog box also contains a 'More' button and a 'Run Test' button. The dialog box text reads: 'Waveform should look like the signal(s) as shown. Click More for details.' The dialog box also displays a smaller version of the waveform viewer with four channels (Ch1, Ch2, Ch3, Ch4) and a 'More' button. The dialog box status bar shows: 'Source -> Rise Time', 'Clock -> Ch1; Data0 -> Ch2; Data1 -> Ch3; Data2 -> Ch4; Acqs -> 10k; High -> 80%; Low -> 20%; Tbit: Recalc; Avgs -> 100'.

Fall Time

Click **View Waveform** to display the input signals Clock or Data as follows:

The image displays two screenshots from the TDSHT3 software. The top screenshot is a Tektronix oscilloscope window showing four channels of digital signals (yellow, cyan, magenta, and green) with a vertical cursor. The bottom screenshot is the 'View Waveform' dialog box, which includes a navigation menu (Select, Configure, Connect, View Waveform), a central waveform preview, and a 'Run Test' button. The status bar at the bottom of the dialog provides test parameters: Source -> Fall Time, Clock -> Ch1, Data0 -> Ch2, Data1 -> Ch3, Data2 -> Ch4, Acqs -> 10k, High -> 80%, Low -> 20%, Tbit: Recalc, Avgs -> 100.

Clock Jitter

Click **View Waveform** to display the Clock signal as follows:

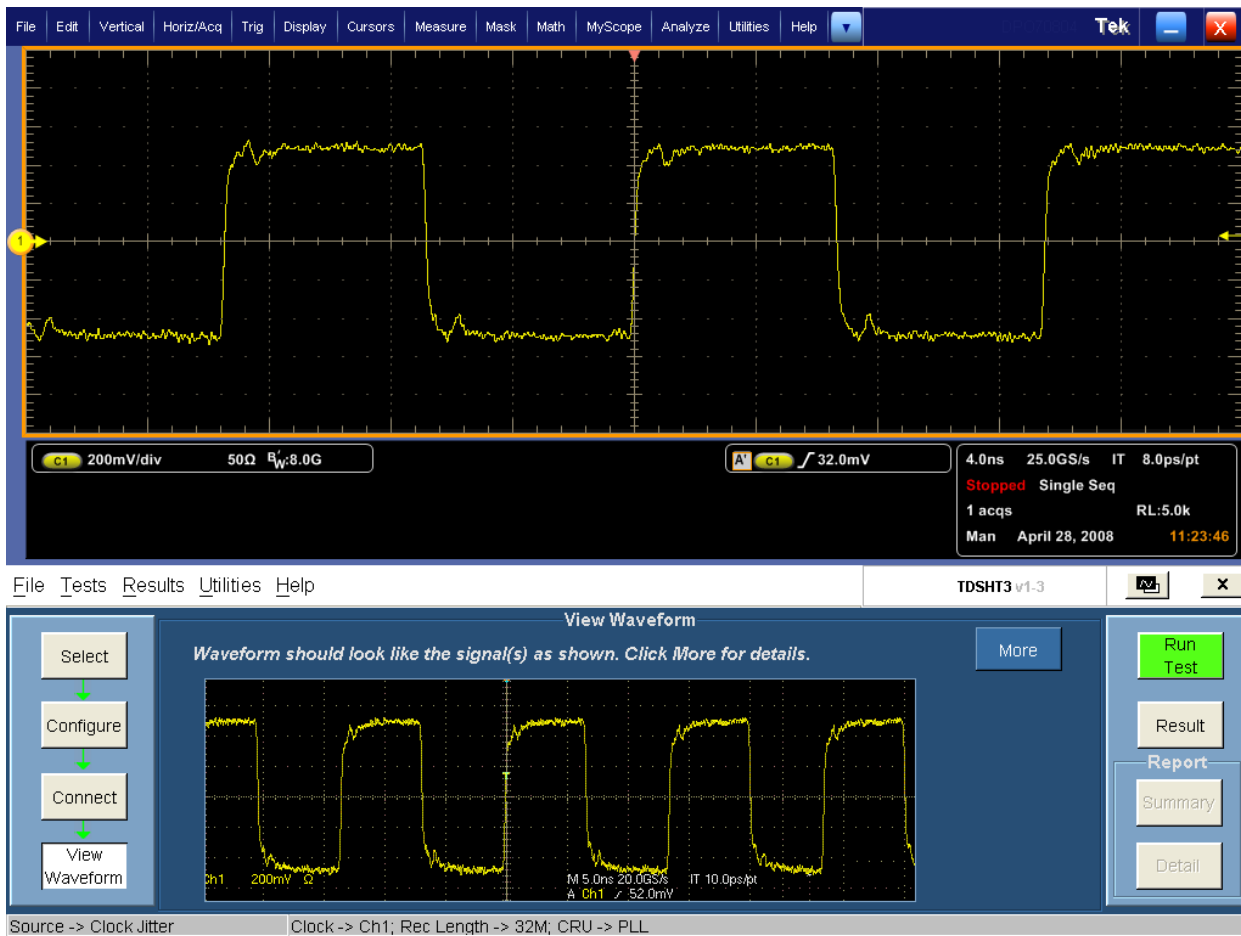

Inter-Pair Skew

Click **View Waveform** to display the input signals Data+ and Data- , Clock as follows:

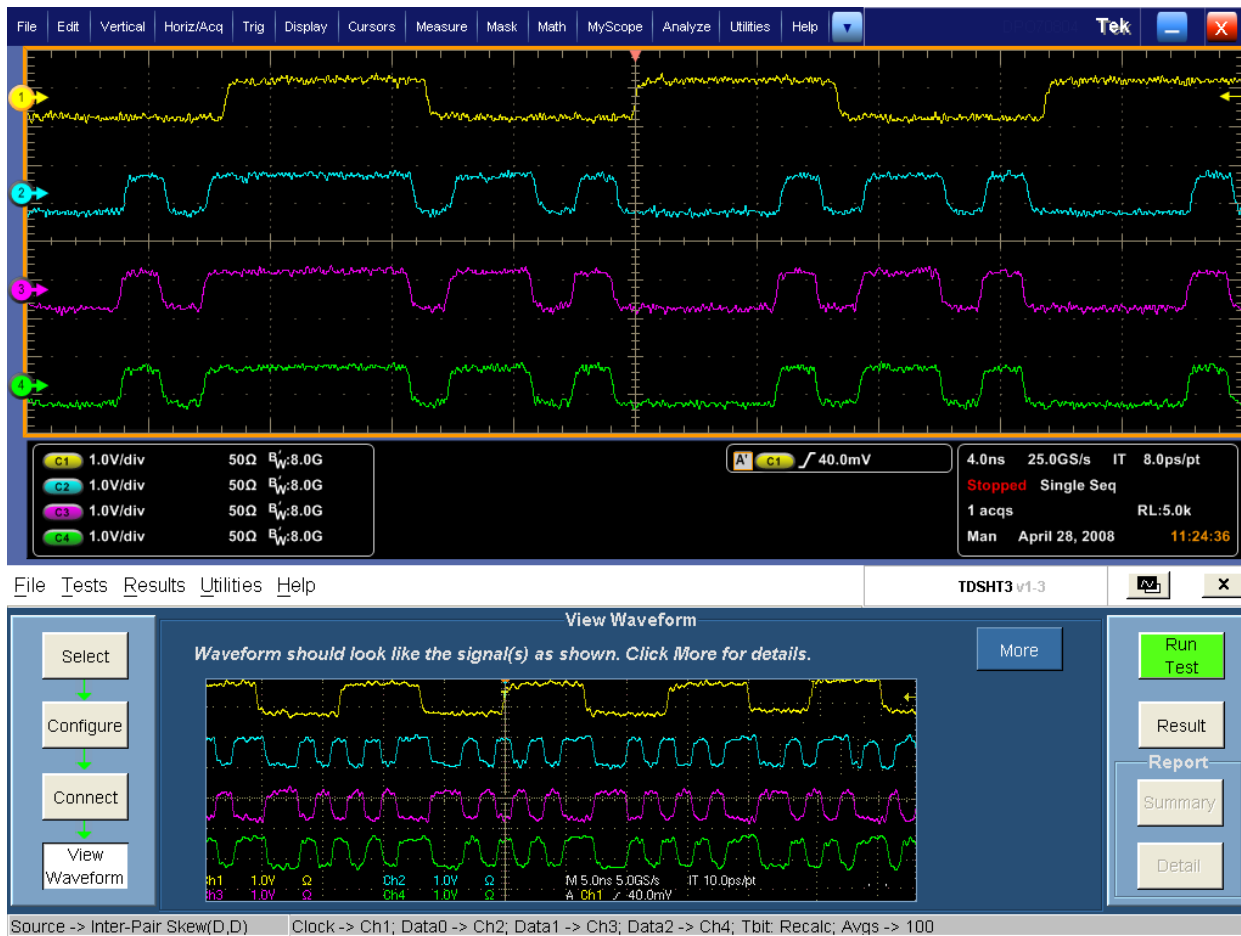

Differential Tests Select All

Click **View Waveform** to display the input signals Clock and Data as follows:

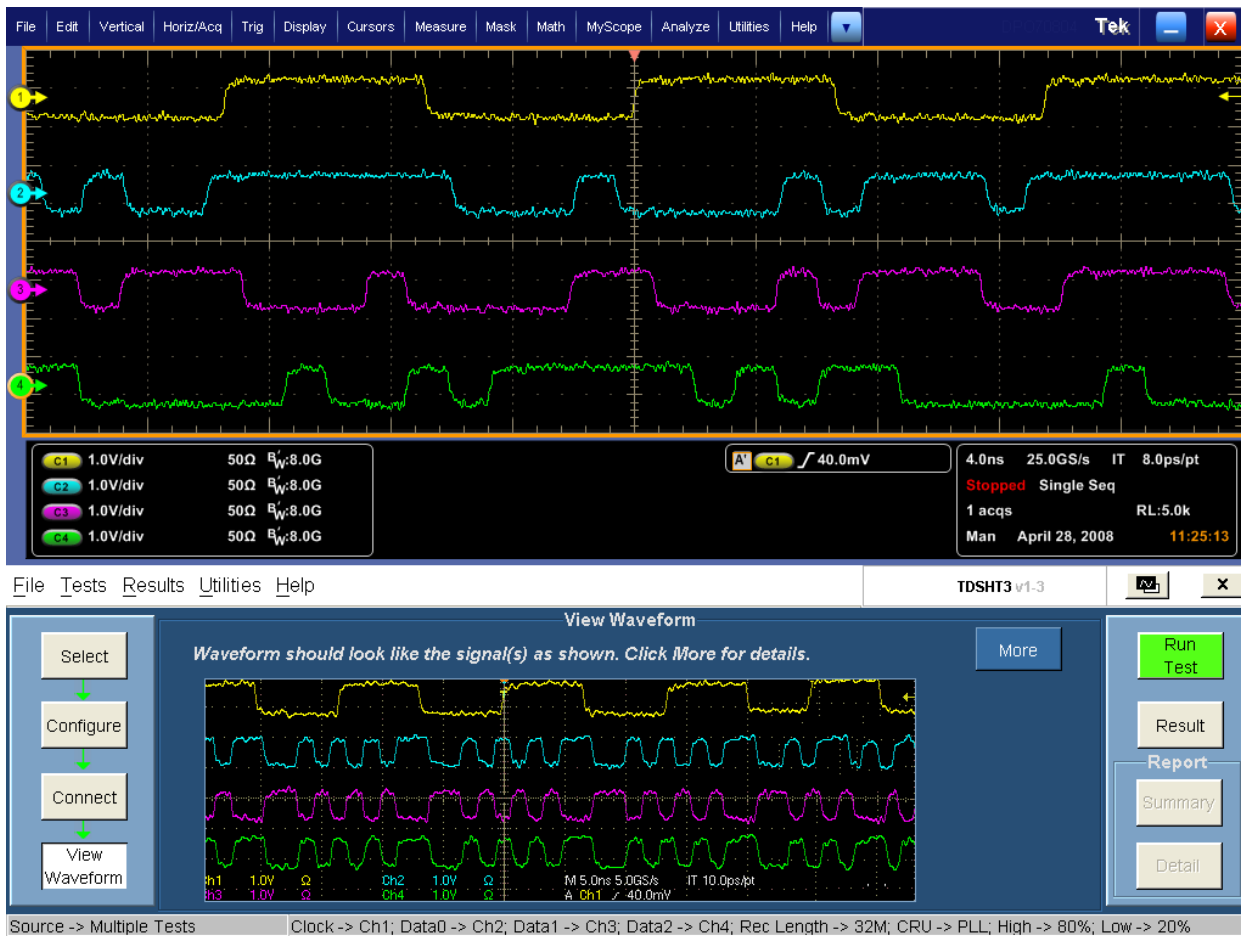

NOTE. Similarly, click **View Waveform** to display a waveform for Single-Ended Tests Select All.

Intra-Pair Skew (Source)

Click **View Waveform** to display the input signals Data+ or Data-/Clock as follows:

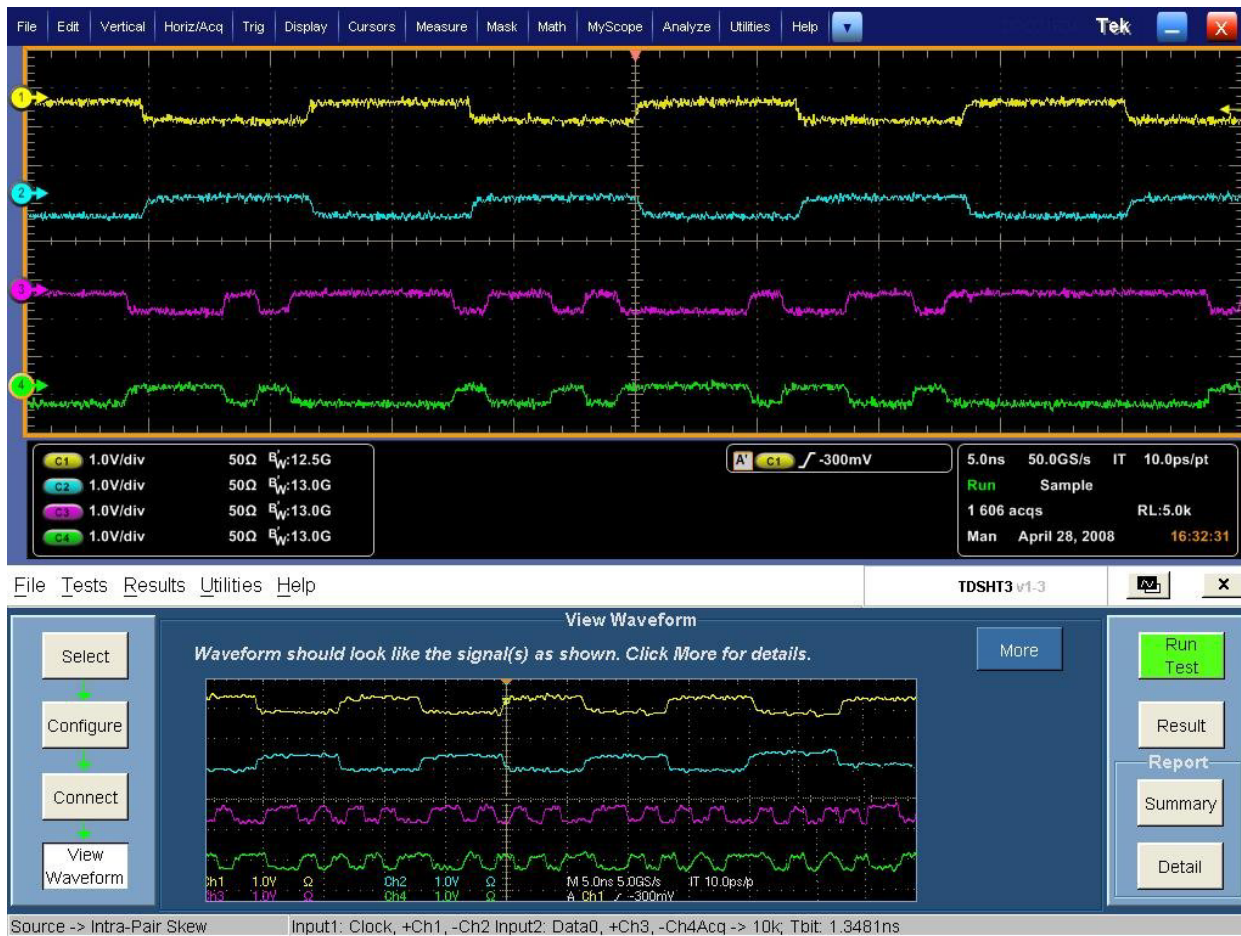

Low Amplitude +

Click **View Waveform** to display the input signals Data+ or Data-/Clock as follows:

The screenshot displays a Tektronix oscilloscope interface. The main window shows two waveforms: a yellow signal (Ch1) and a purple signal (Ch2). The yellow signal is a square wave with a period of approximately 5 ns. The purple signal is a square wave with a period of approximately 1 ns. The oscilloscope settings are: 500mV/div, 50Ω, BW: 12.5G for Ch1; 500mV/div, 50Ω, BW: 13.0G for Ch2. The acquisition mode is Run, Sample, with 1345 acquisitions. The date and time are April 28, 2008, 16:33:14. The 'View Waveform' dialog box is open, showing a zoomed-in view of the waveforms. The dialog includes a 'More' button, a 'Run Test' button, and a 'Report' section with 'Result', 'Summary', and 'Detail' buttons. The source is 'Low Amplitude +' and the input is 'Clock,+Ch1 Input2: Data0,+Ch3Acq -> 10k; AVcc -> 3.3V; Tbit: 1.3481ns'.

Low Amplitude -

Click **View Waveform** to display the input signals Data+ or Data-/Clock as follows:

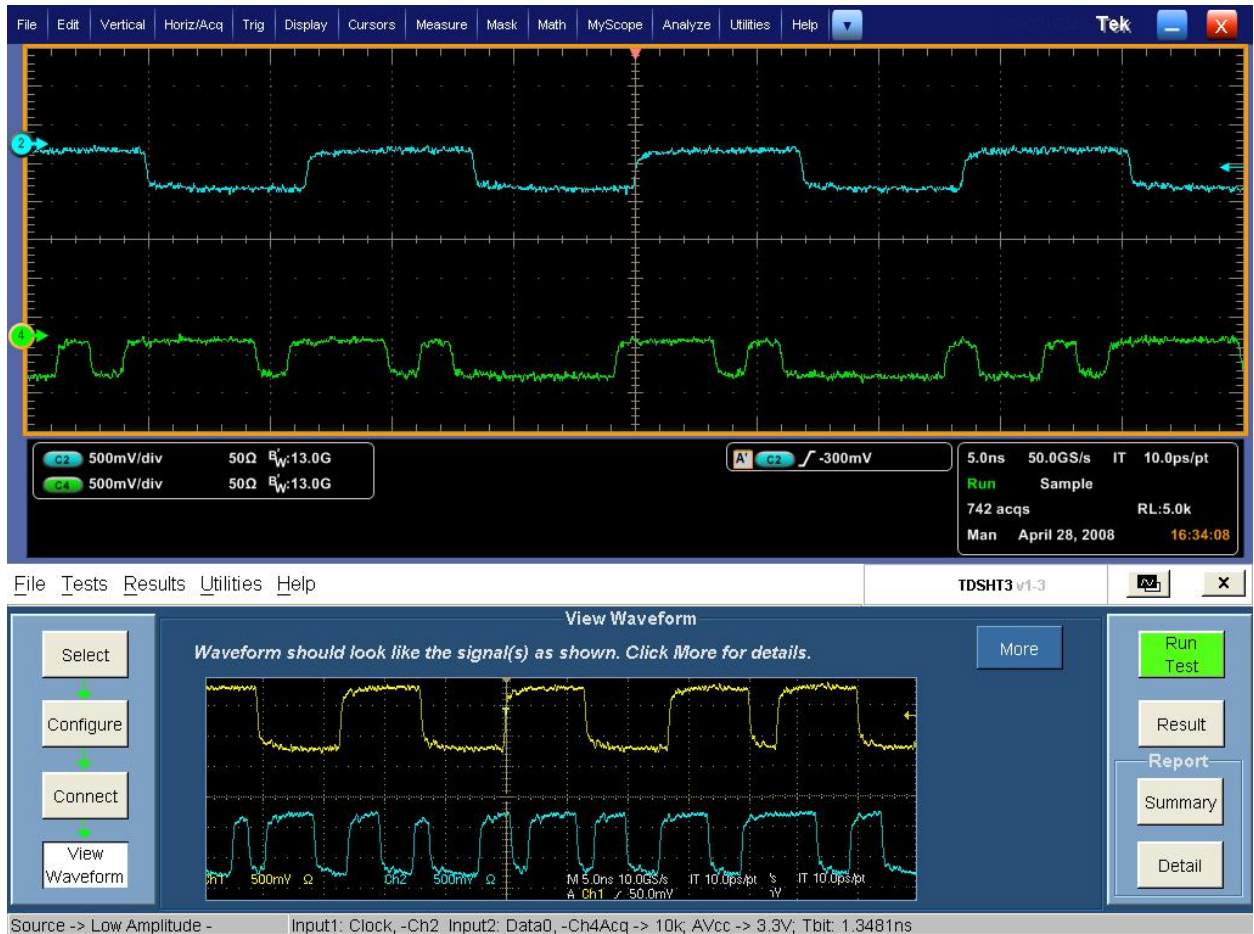

Min/Max-Diff Swing Tolerance

Because no signal is connected to the oscilloscope, you cannot view the waveform for the Min/Max-Diff Swing Tolerance test.

Jitter Tolerance

Because no signal is connected to the oscilloscope, you cannot view the waveform for the Jitter Tolerance test.

Intra-Pair Skew (Sink)

Because no signal is connected to the oscilloscope, you cannot view the waveform for the Intra-Pair Skew test.

Eye Diagram (Cable)

Because no signal is connected to the oscilloscope, you cannot view the waveform for the Eye Diagram test.

Eye Diagram (Source)

This test allows you to confirm that the differential signal on each TMDS differential data pair has an “eye opening” (region of valid data) which meets or exceeds the limits on eye opening in the specification.

You will need one supported oscilloscope, two/four differential probes, one DC power supply 3.3 V, one EDID emulator, and one TPA-P fixture.

NOTE. For the DPO/DSA70000 series oscilloscopes with P7313 SMA probes and Efficere fixtures, you have the option to set the probe control voltage to **internal** from the [Preferences](#) menu. If this option is selected, an external power supply is not required.

1. On the menu bar, click **Tests > Select > Source**.
2. In the differential tests pane, select the Eye Diagram check box.

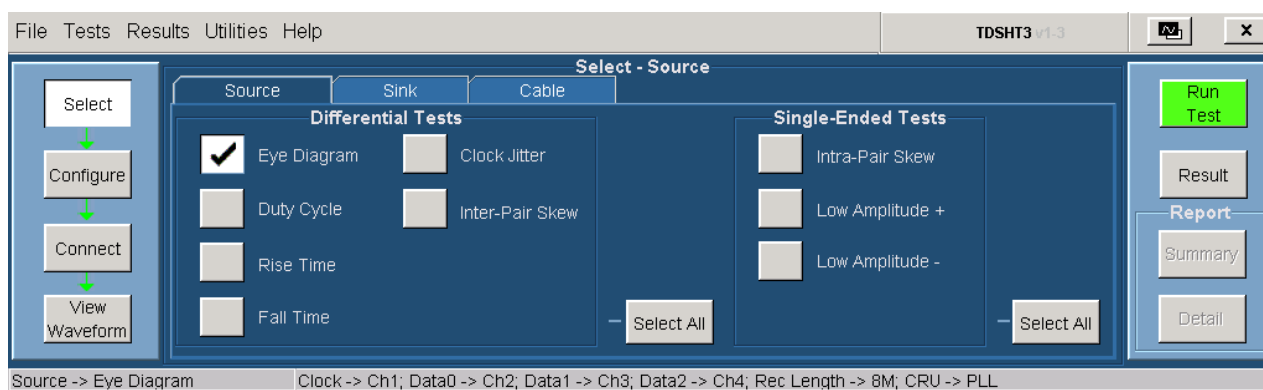

3. To change the configuration settings, click **Tests > Configure**. For most tests, you can use the factory default configuration. However, you can change the values by using the [virtual keyboard](#) or the [general purpose knob](#) on the oscilloscope front panel. Using the File menu, you can also restore the factory

defaults or save and recall your own configuration settings. It is recommended that you save the configuration settings before you choose to select Recall Default or close the application.

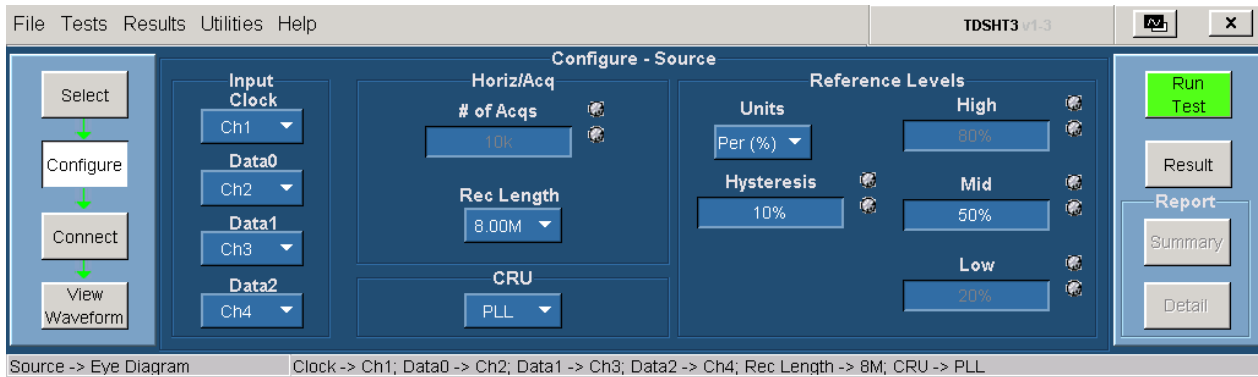

4. In the input pane, you have the following options:

Configure parameter	Description
Clock	Clock indicates the source channel to which you will connect the HDMI clock input lane. The available choices are Ch1, Ch2, Ch3, Ch4, Ref1, Ref2, Ref3, and Ref4.
Data0	Data0 indicates the source channel to which you will connect the HDMI data0 input lane. The available choices are Ch1, Ch2, Ch3, Ch4, Ref1, Ref2, Ref3, Ref4 and Not Conn.
Data1	Data1 indicates the source channel to which you will connect the HDMI data1 input lane. The available choices are Ch1, Ch2, Ch3, Ch4, Ref1, Ref2, Ref3, Ref4 and Not Conn.
Data2	Data2 indicates the source channel to which you will connect the HDMI data2 input lane. The available choices are Ch1, Ch2, Ch3, Ch4, Ref1, Ref2, Ref3, Ref4 and Not Conn.

5. In the horiz/acq pane, you have the following option:

Configure parameter	Description
Record Length	In the Rec Length box, enter the desired record length value for the eye tests.

6. In the CRU pane, you have the following option:

Configure parameter	Description
CRU	The CRU list allows you to configure the Clock Recovery Unit. The available choices are PLL, Raw, and Ideal. The default value is first order PLL and is used for compliance testing. Raw and Ideal are used for analysis.

7. In the reference levels pane, you have the following options:

Configure parameter	Description
Units	<p>The Units list allows you to set the reference level units to either Per (%) or Abs.</p> <p>Per (%) indicates that the reference levels are a percentage of the Vswing value.</p> <p>Abs indicates that the reference levels are absolute voltage values.</p>
Hysteresis	<p>In the Hysteresis box, enter the desired hysteresis percent value. The default value is 10 percent.</p> <p>The hysteresis range is between 2 percent and 10 percent.</p>
Mid	<p>In the Mid box, enter the desired mid reference voltage value. The default value is 50 percent.</p>

8. To connect the DUT, click **Tests > Connect**. [Click here](#) for information on how to make connections.

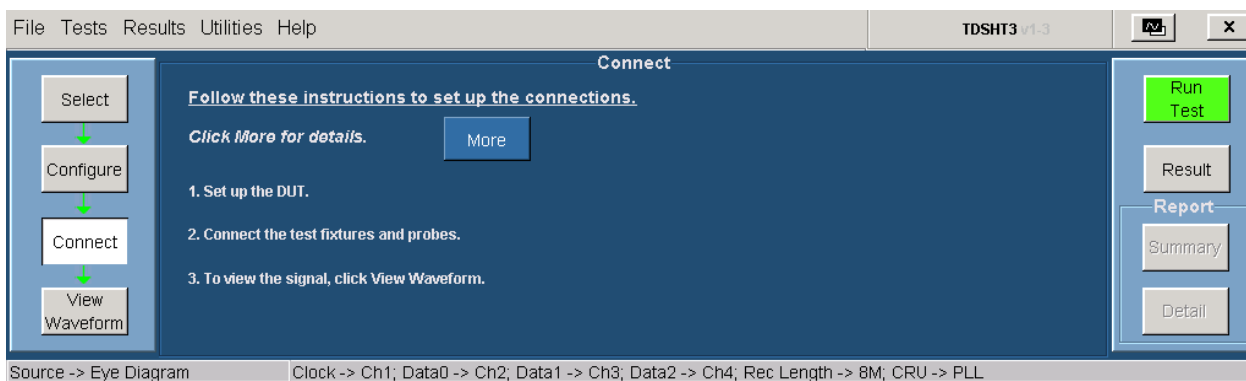

9. Ensure that your signal in the oscilloscope display is similar to the sample signal. Click **View Waveform** to display a sample of the expected signal. If the displays are not similar, go back and check your configuration and connections.

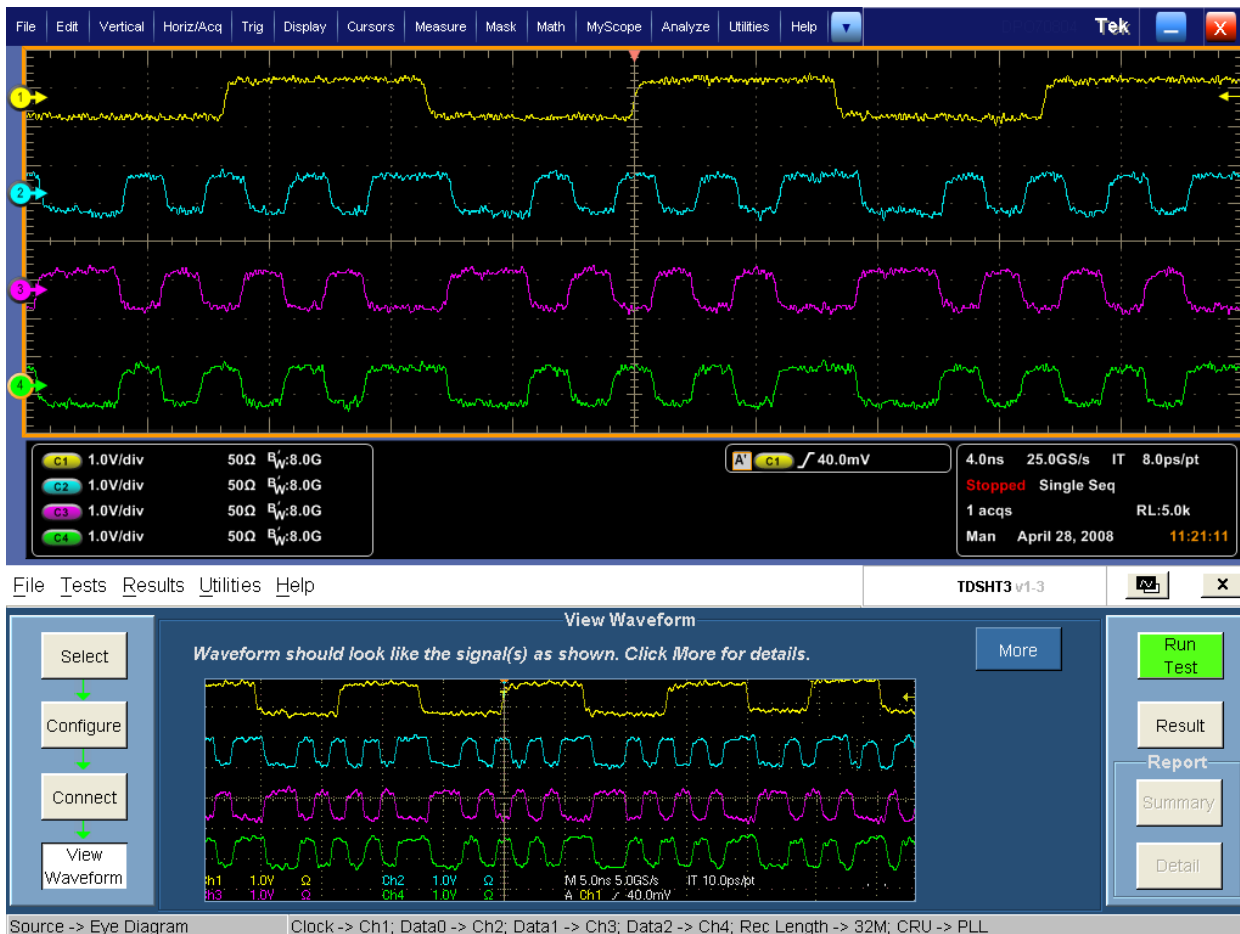

10. Click **Run Test** to perform the test. The TDSHT3 HDMI Compliance Test Software sets up the oscilloscope and the test runs, displaying a progress indicator.

11. If you have run the eye diagram test successfully, the software makes Result available automatically and displays the eye diagram plot.

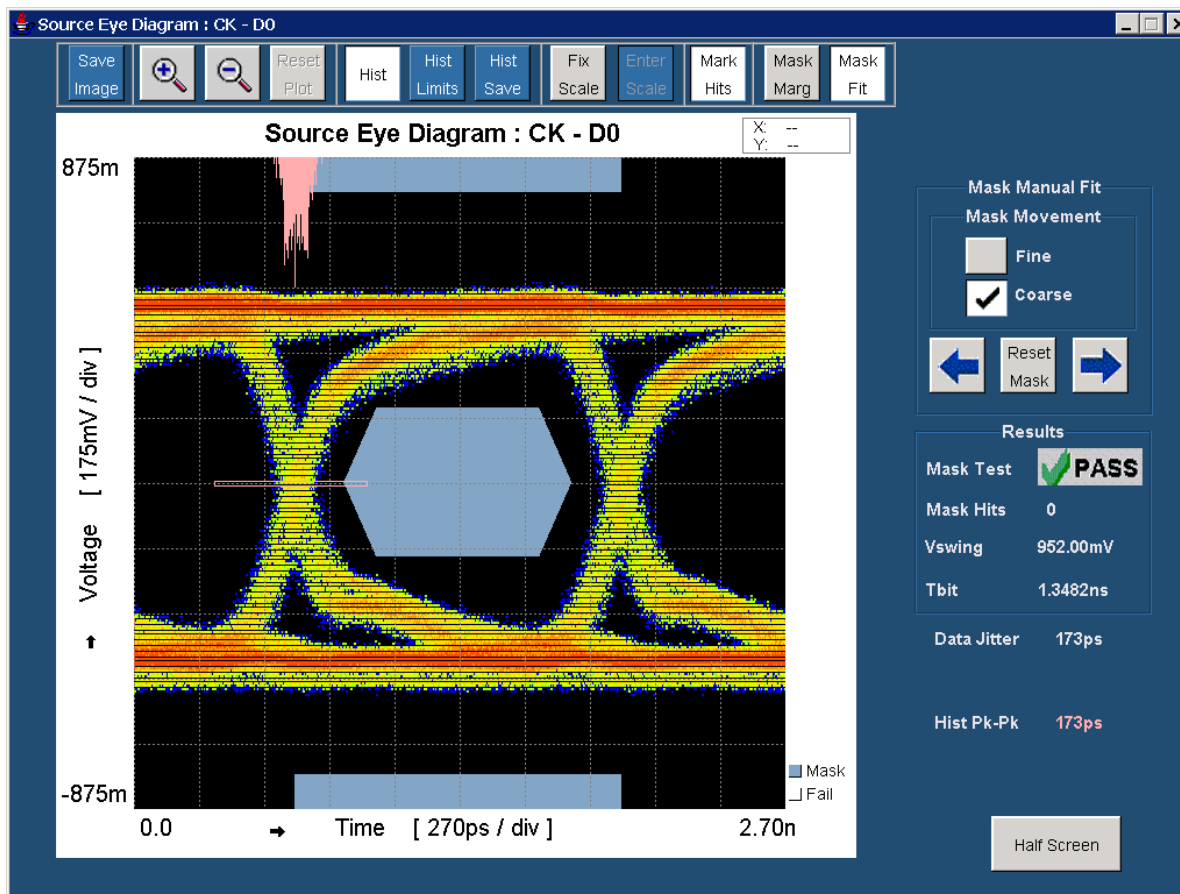

NOTE. In the full screen mode, the histogram disappears if you click anywhere within the plot.

- The name of the buttons available on the eye diagram plot and their descriptions are as follows:

Options	Description
Save Image	Click Save Image to save the eye diagram plot.
Zoom-In	Click the Zoom-In icon to zoom the area of interest. You can zoom up to five times the normal view. Either drag the mouse or click to zoom in to define the area of interest.
Zoom-Out	Click the Zoom-out icon to zoom out.
Reset Plot	Click Reset Plot to reset the plot.
Hist	Click Hist to draw the histogram.
Hist Limits	Click Hist Limits to draw the histogram box.
Hist Save	Click Hist Save to save the histogram.
Fix Scale	Click Fix Scale to allow the user to type a new scale value.

Options	Description
Enter Scale	Click Enter Scale to allow the user to type a new scale value in the Vertical Scale box.
Mark Hits	Click Mark Hits to mark the hits in the eye diagram plot.
Mask Marg	Click Mask Marg to display the margins on the eye diagram plot.
Mask Fit	Click Mask Fit to enable to move the mask either in the left or the right direction. Mask Marg and Mask Fit are mutually exclusive of each other.
Mask Manual Fit pane	You can use this pane to move the mask either in the left or the right direction. You can select either a fine or a coarse movement.
Results pane	The results pane displays the mask test result, number of mask hits, Vswing value, and the Tbit value. The Data Jitter and the Hist Pk-Pk values are also shown near the results pane.
Half Screen	Click Half Screen to show the plot in half screen.
Full Screen	Click Full Screen to maximize the plot to full screen.

- Click **Hist** to draw the histogram on the eye diagram plot.
- Click **Hist Limits** to draw a histogram box.
- Double-click the buttons next to the Ymax, Ymin, Xmin, and Xmax labels to type the X and Y histogram limits.



- The results pane displays the mask test result, number of mask hits, Vswing value, and the Tbit value. The Data Jitter and the Hist Pk-Pk values are also shown near the results pane. If there is no value for data jitter, then it implies the absence of data points in the histogram window. In this case, increase the record length value and run the test again.



Result name	Description
Mask Test	View the mask test result as either Pass, Conditional Pass, or Fail.
Mask Hits	View the number of mask hits.
Vswing	View the voltage swing of the signal.
Tbit	View the time period of each bit.

12. Click **Half Screen** to view the eye diagram plot in half screen. You can also view both the result summary of the test and the report configuration in the result pane as shown in the following figure.

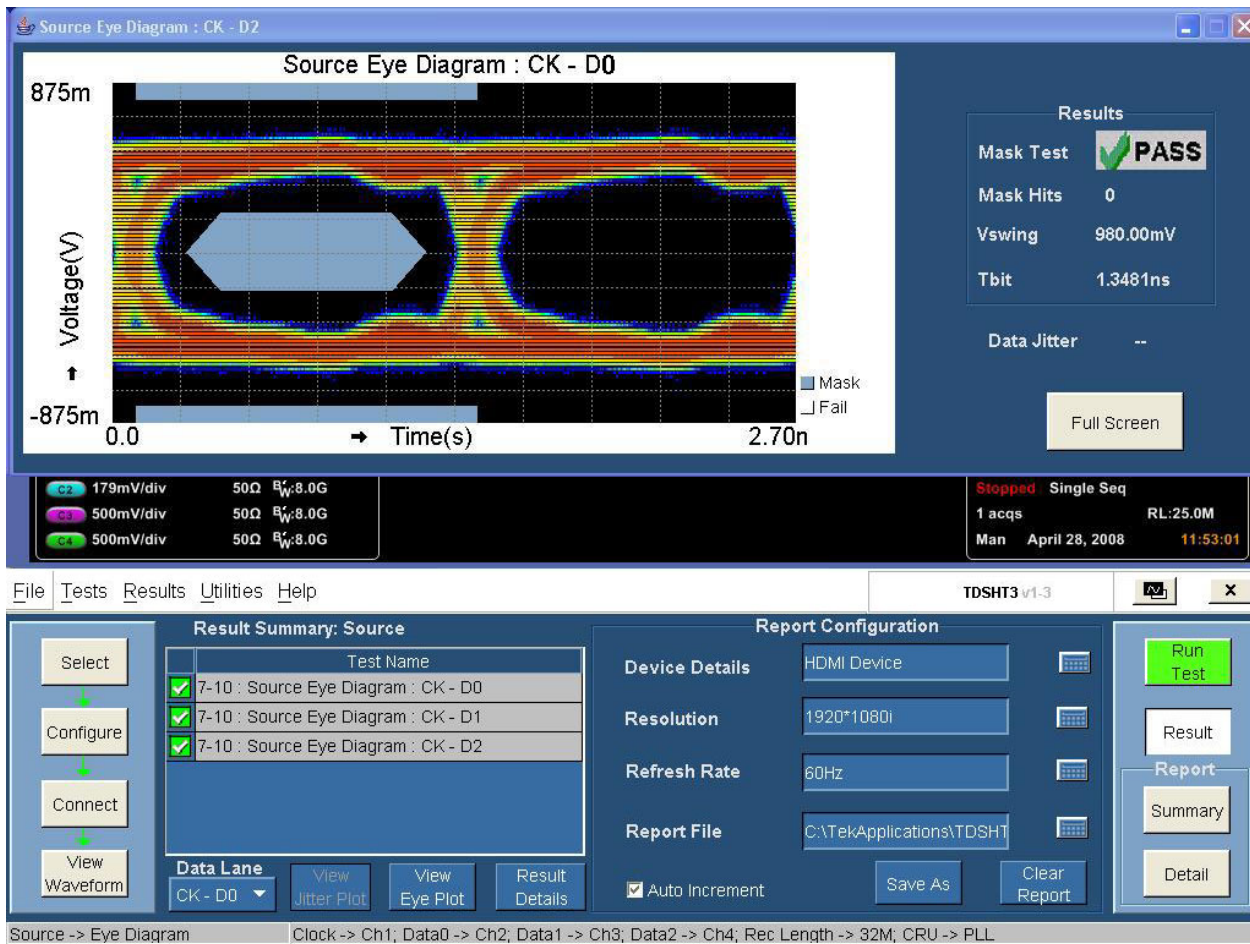



The result pane comprises both the result summary pane and the report configuration pane.

Result Summary pane

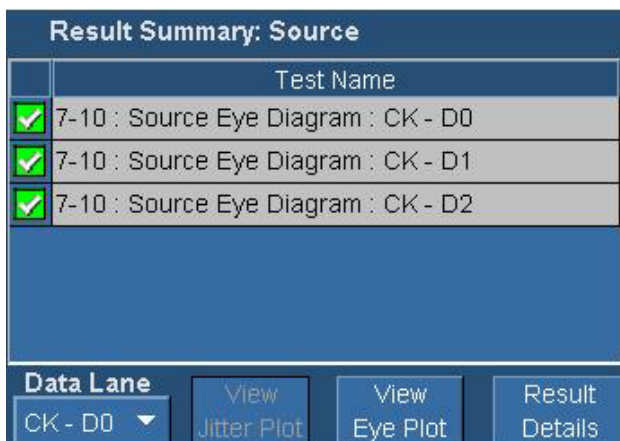
The result summary pane displays the test results.



 This icon indicates that the test has passed.

 This icon indicates that the test has failed.

 This icon indicates that the test could not be run.

Options	Description
Test Name	The Test Name box displays the test id, test name, and selected lanes.
Status	Status indicates the status of the test as Pass, Fail, or Error.
Data Lane	Select the data lane pair for which to display the corresponding eye diagram plot.
View Jitter Plot	Click View Jitter Plot to view the jitter plot for the selected test point for the eye diagram test.
View Eye Plot	Click View Eye Plot to view the eye plot for the selected test point for the eye diagram test.
Result Details	Click Result Details to display the details of the result.

Report Configuration pane

You can set the report details to identify and generate the report automatically. You can set a default report file.

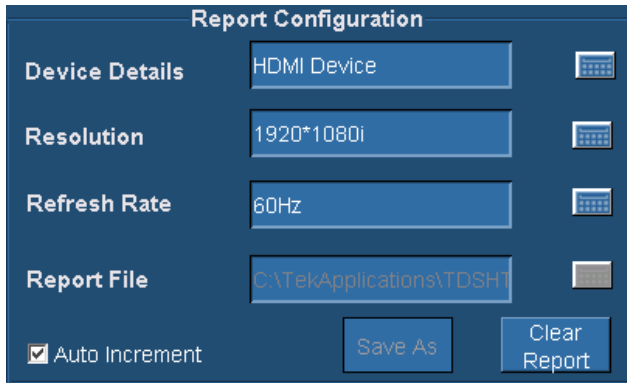

The screenshot shows the 'Report Configuration' dialog box. It has a dark blue background with white text. The fields are:

- Device Details: HDMI Device
- Resolution: 1920*1080i
- Refresh Rate: 60Hz
- Report File: C:\TekApplications\TDSHT

 At the bottom left, there is a checked checkbox labeled 'Auto Increment'. At the bottom right, there are two buttons: 'Save As' and 'Clear Report'.

In the report configuration pane, you can configure the following parameters:

Category	Description
Device Details	The Device Details box allows you to specify the device-related information on which the test is conducted.
Resolution	The Resolution box allows you to specify the resolution on which the test is conducted.
Refresh Rate	The Refresh Rate box allows you to specify the refresh rate at which the test is conducted.

Category	Description
Report File	The Report File box allows you to specify the path and the file where the generated report will be saved. However, a default file name and path already exists.
Auto Increment	Select the Auto Increment check box to generate a new report. Selecting this option does not overwrite the existing report. However, it adds the date and time to the existing file name.
Save As	Click Save As to save the generated reports. The Save File dialog box is displayed. You can enter a file name and save the report.
Clear Report	Click Clear Report to clear all the results and records of the earlier tests.

13. In the result summary pane, click **Result Details** to display the details of the result.

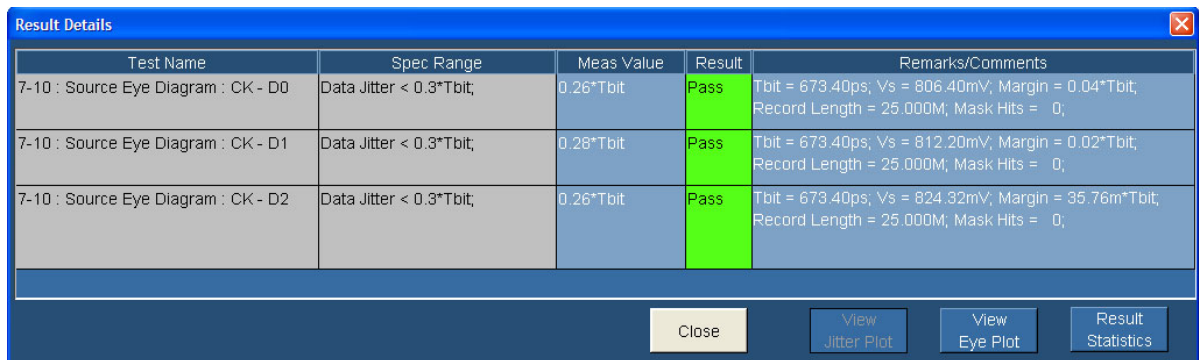

Options	Description
Test Name	The Test Name column displays the test id, test name, and selected lanes.
Spec Range	The Spec Range column describes the HDMI standards and test specifications limit for the test.
Meas Value	The Meas Value column displays the measured value.
Result	The Result column displays the status of the test as Pass, Conditional Pass, Fail, or Error.
Remarks/Comments	The Remarks/Comments column displays the results of Tbit, Vswing, and Margin. If the test could not be run, then an error code appears.
Close	Click Close to quit the Result Details dialog box.
View Eye Plot	Click View Eye Plot to display the eye plot.
Result Statistics	Click Result Statistics to display statistics based on the tests.

14. In the Result Details dialog box, click **Result Statistics** to display statistics based on the tests.

Test Name	Population	Min	Max	Mean	Std Dev	Pk-Pk
Source Eye Diagram : Tx Clock TIE	47.473k	-343.83ps	462.61ps	0.00s	129.86ps	806.44ps
Source Eye Diagram : Recovered Clock...	47.473k	-319.61ps	447.14ps	40.671ps	122.33ps	766.75ps

Close

The software calculates statistics for each selected test, and logs the statistics on a cycle-by-cycle basis in a large waveform. The standard statistics are for the Maximum, Minimum, Mean, Standard Deviation, and Population.

Options	Description
Test Name	The Test Name column displays the test id, test name, and selected lanes.
Population	The software calculates this statistic by using the following equation: Population (X) = N
Min	The software calculates this statistic by using the following equation: Min (X) = Lowest value of X
Max	The software calculates this statistic by using the following equation: Max (X) = Highest value of X
Mean	The software calculates this statistic by using the following equation: $Mean (X) = \bar{X} = \frac{1}{N} \sum_{n=1}^N X_n$
Std Dev	The software calculates this statistic by using the following equation: $Standard Deviation (X) = \sigma_x = \sqrt{\frac{1}{(N-1)} \sum_{n=1}^N (X_n - \bar{X})^2}$
Pk-Pk	The software calculates this statistic by using the following equation: Xppn = Max(X) – Min(X)
Close	Click Close to quit the Result Statistics dialog box.

Duty Cycle

This test allows you to confirm that the duty cycle of the differential TMDS clock does not exceed the limits allowed by the specification.

You will need one supported oscilloscope, one differential probe, one DC power supply 3.3 V, one EDID emulator, and one TPA-P fixture.

NOTE. For the DPO/DSA70000 series oscilloscopes with P7313 SMA probes and Efficere fixtures, you have the option to set the probe control voltage to **internal** from the [Preferences](#) menu. If this option is selected, an external power supply is not required.

1. On the menu bar, click **Tests > Select > Source**.
2. In the differential tests pane, select the Duty Cycle check box.

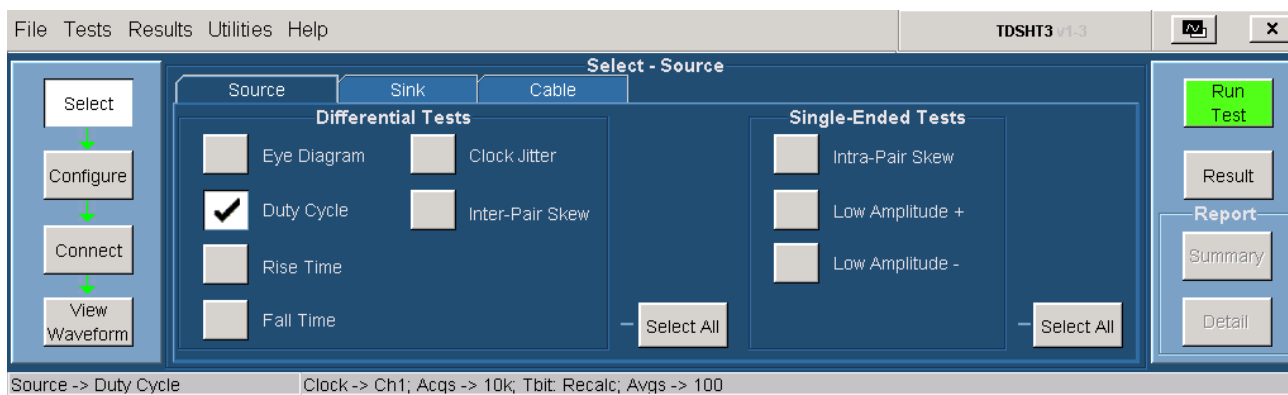

3. To change the configuration settings, click **Tests > Configure**. For most tests, you can use the factory default configuration. However, you can change the values by using the [virtual keyboard](#) or the [general purpose knob](#) on the oscilloscope front panel. Using the File menu, you can also restore the factory defaults or save and recall your own configuration settings. It is recommended that you save the configuration settings before you choose to select Recall Default or close the application.

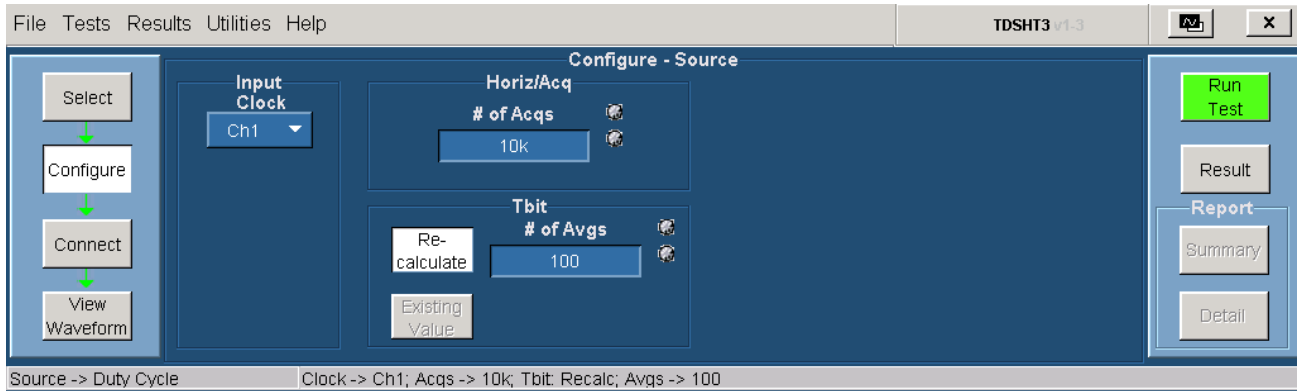

4. In the input pane, you have the following option:

Configure parameter	Description
Clock	Clock indicates the source channel to which you will connect the HDMI clock input lane. The available choices are Ch1, Ch2, Ch3, and Ch4.

5. In the horiz/acq pane, you have the following option:

Configure parameter	Description
# of Acqs	In the # of Acqs box, enter the desired number of acquisitions that are required for the test. The default value is 10 K.

6. In the tbit pane, you have the following options:

Configure parameter	Description
# of Avgs	In the # of Avgs box, enter the desired number of periods that are considered to calculate Tbit. The default value is 100.
Re-calculate	Click Re-calculate to recalculate the Tbit value.
Existing Value	Click Existing Value to use the previously calculated Tbit value.

7. To connect the DUT, click **Tests > Connect**. [Click here](#) for information on how to make connections.

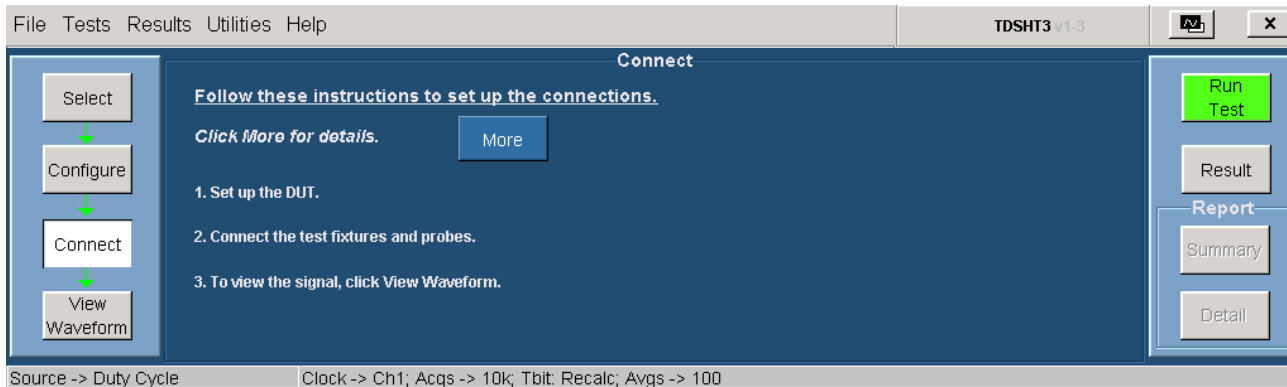

- 8. Ensure that your signal in the oscilloscope display is similar to the sample signal. Click **View Waveform** to display a sample of the expected signal. If the displays are not similar, go back and check your configuration and connections.

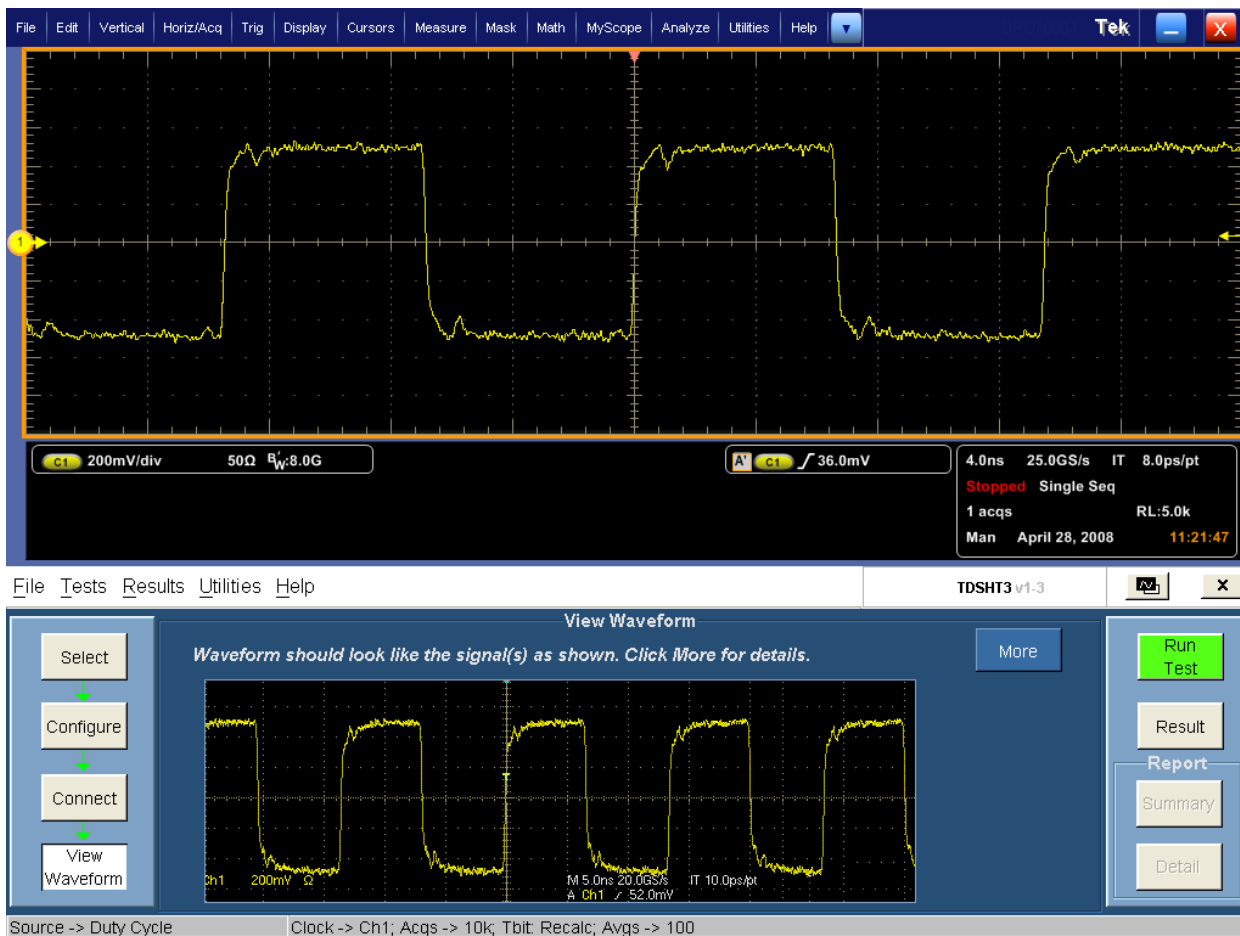

- 9. Click **Run Test** to run the test. The TDSHT3 HDMI Compliance Test Software sets up the oscilloscope and the test runs, displaying a progress indicator.

10. The software makes Result available automatically and displays the result summary. You can also view the report configuration details in the result pane.

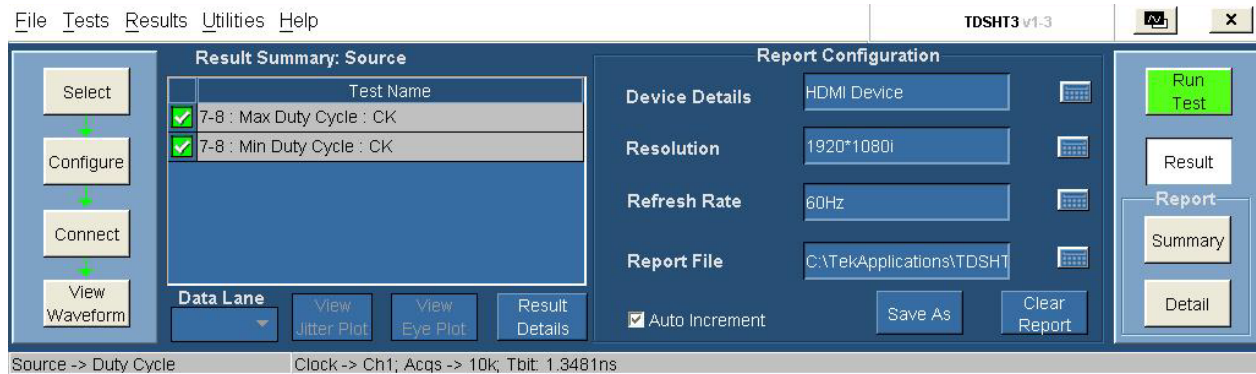

Option	Description
Test Name	The Test Name box displays the test id, test name, and lane.
Status	Status indicates the status of the test as Pass, Fail, or Error.
Result Details	Click Result Details to display the details of the result.

11. You can set the report details to identify and generate the report automatically. You can set a default report file.

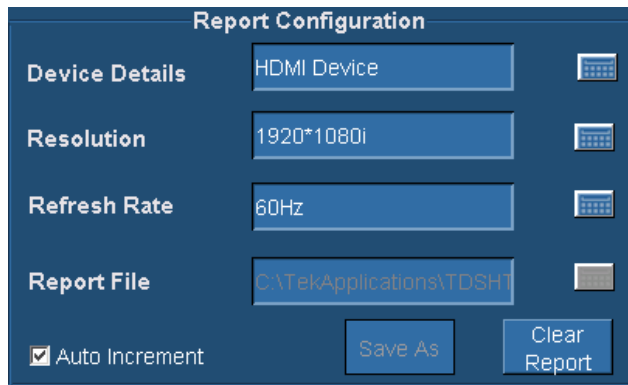

In the report configuration pane, you can configure the following parameters:

Category	Description
Device Details	The Device Details box allows you to specify the device-related information on which the test is conducted.
Resolution	The Resolution box allows you to specify the resolution on which the test is conducted.
Refresh Rate	The Refresh Rate box allows you to specify the refresh rate at which the test is conducted.

Category	Description
Report File	The Report File box allows you to specify the path and the file where the generated report will be saved. However, a default file name and path already exists.
Auto Increment	Select the Auto Increment check box to generate a new report. Selecting this option does not overwrite the existing report. However, it adds the date and time to the existing file name.
Save As	Click Save As to save the generated reports. The Save File dialog box is displayed. You can enter a file name and save the report.
Clear Report	Click Clear Report to clear all the results and records of the earlier tests.

12. In the result summary pane, click **Result Details** to display the details of the result.

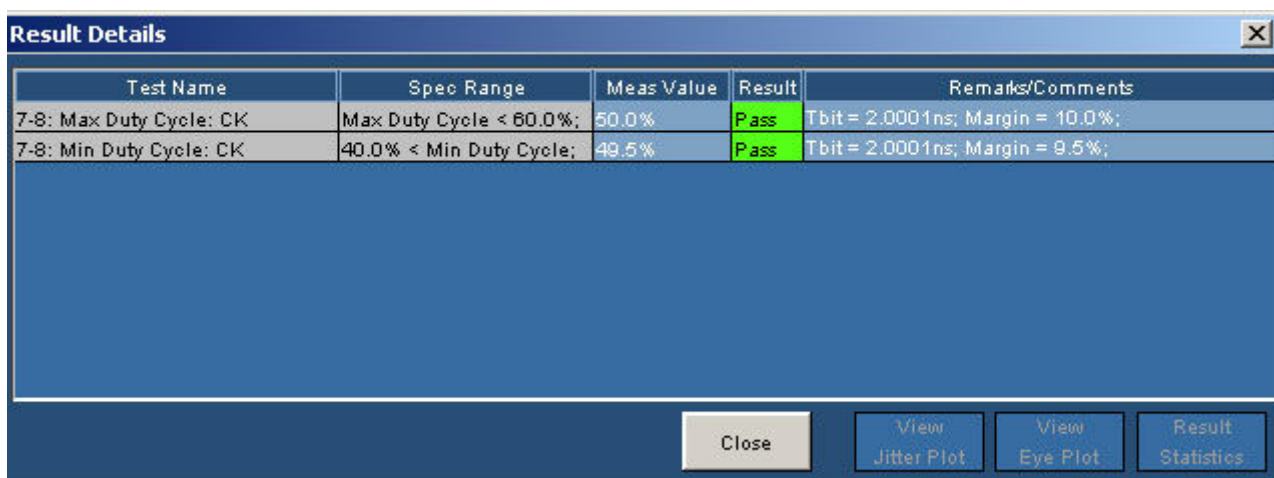

Options	Description
Test Name	The Test Name column displays the test id, test name, and lane.
Spec Range	The Spec Range column displays the HDMI standards and test specifications limit for the test.
Meas Value	The Meas Value column displays the measured value.
Result	The Result column displays the status of the test as Pass, Fail, or Error.
Remarks/Comments	The Remarks/Comments column displays the relevant details, for example, Tbit, and Margin. If the test could not be run, then an error code appears.
Close	Click Close to quit the Result Details dialog box.

Rise Time

This test allows you to confirm that the rise times on the TMDS differential signals fall within the limits of the specification.

You will need one supported oscilloscope, one differential probe, one DC power supply 3.3 V, one EDID emulator, and one TPA-P fixture.

NOTE. For the DPO/DSA70000 series oscilloscopes with P7313 SMA probes and Efficere fixtures, you have the option to set the probe control voltage to **internal** from the [Preferences](#) menu. If this option is selected, an external power supply is not required.

1. On the menu bar, click **Tests > Select > Source**.
2. In the differential tests pane, select the Rise Time check box

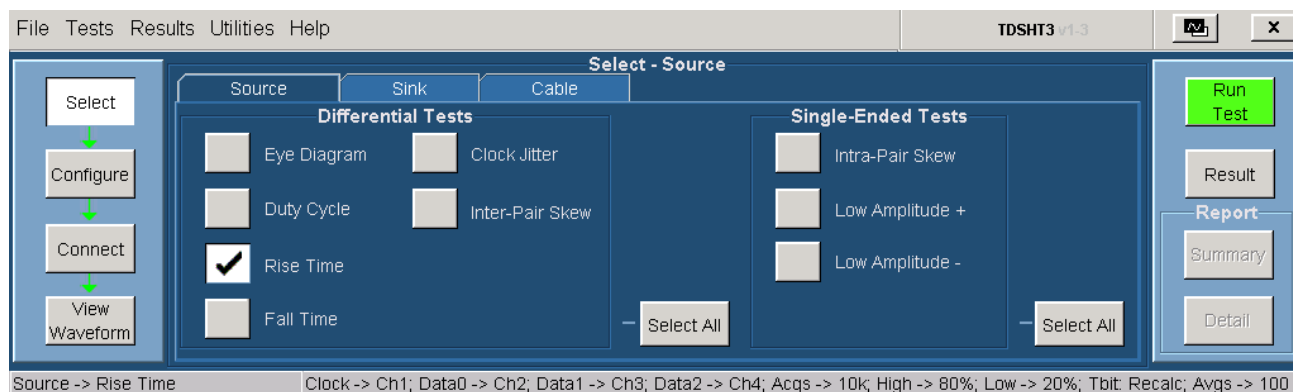

3. To change the configuration settings, click **Tests > Configure**. For most tests, you can use the factory default configuration. However, you can change the values by using the [virtual keyboard](#) or the [general purpose knob](#) on the oscilloscope front panel. Using the File menu, you can also restore the factory defaults or save and recall your own configuration settings. It is recommended that you save the configuration settings before you choose to select Recall Default or close the application.

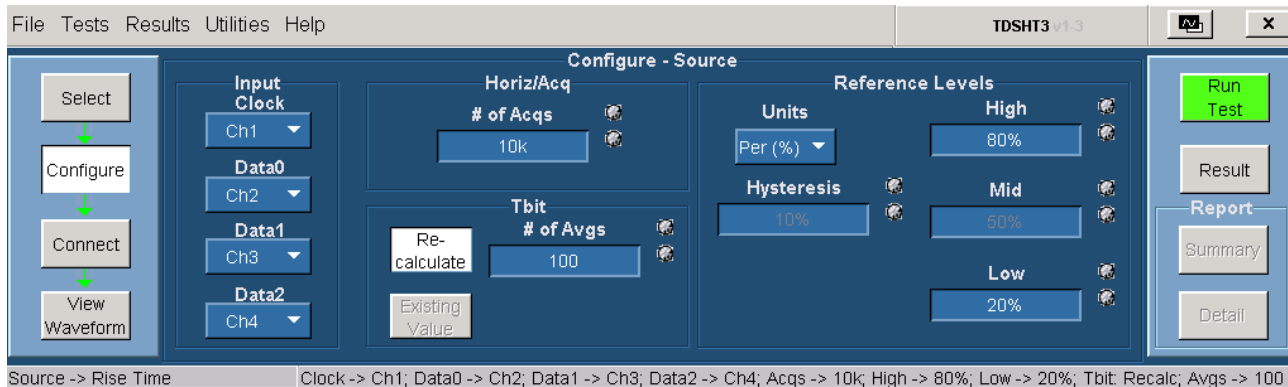

4. In the input pane, you have the following options:

Configure parameter	Description
Clock	Clock indicates the source channel to which you will connect the HDMI clock input lane. The available choices are Ch1, Ch2, Ch3, Ch4, and Not Conn.
Data0	Data0 indicates the source channel to which you will connect the HDMI data0 input lane. The available choices are Ch1, Ch2, Ch3, Ch4, and Not Conn.
Data1	Data1 indicates the source channel to which you will connect the HDMI data1 input lane. The available choices are Ch1, Ch2, Ch3, Ch4, and Not Conn.
Data2	Data2 indicates the source channel to which you will connect the HDMI data2 input lane. The available choices are Ch1, Ch2, Ch3, Ch4, and Not Conn.

5. In the horiz/acq pane, you have the following option:

Configure parameter	Description
# of Acqs	In the # of Acqs box, enter the desired number of acquisitions that are required for the test. The default value is 10 K.

6. In the tbit pane, you have the following options:

Configure parameter	Description
# of Avgs	In the # of Avgs box, enter the desired number of periods that are considered to calculate Tbit. The default value is 100.
Re-calculate	Click Re-calculate to recalculate the Tbit value.
Existing Value	Click Existing Value to use the previously calculated Tbit value.

7. In the reference levels pane, you have the following options:

Configure parameter	Description
Units	The Units list allows you to set the reference level units to either Per (%) or Abs. Per (%) indicates that the reference levels are a percentage of the Vswing value. Abs indicates that the reference levels are absolute voltage values.
Hysteresis	In the Hysteresis box, enter the desired hysteresis percent value. The default value is 10 percent.
High	In the High box, enter the desired high reference voltage value. The default value is 80 percent.
Mid	In the Mid box, enter the desired mid reference voltage value. The default value is 50 percent.
Low	In the Low box, enter the desired low reference voltage value. The default value is 20 percent.

8. To connect the DUT, click **Tests > Connect**. [Click here](#) for information on how to make connections.

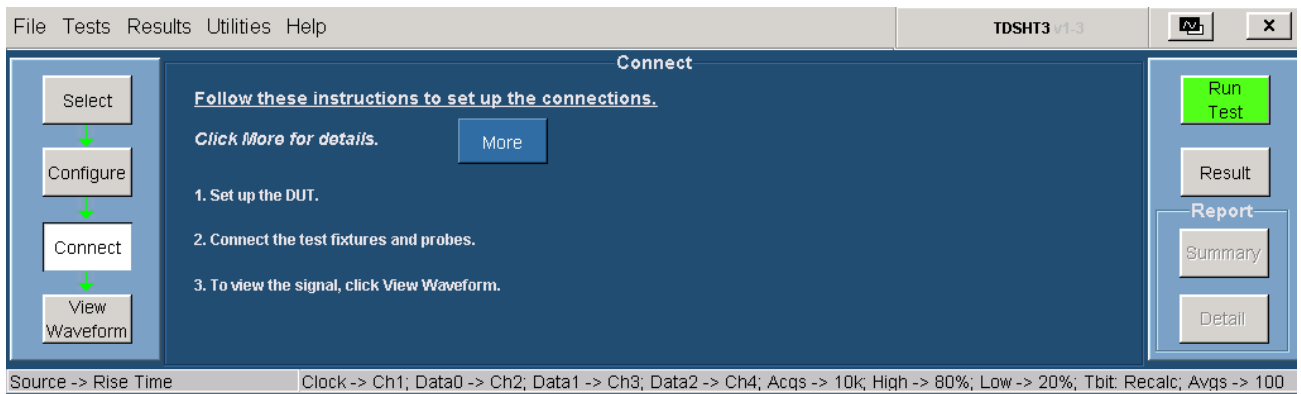

9. Ensure that your signal in the oscilloscope display is similar to the sample signal. Click **View Waveform** to display a sample of the expected signal. If the displays are not similar, go back and check your configuration and connections.

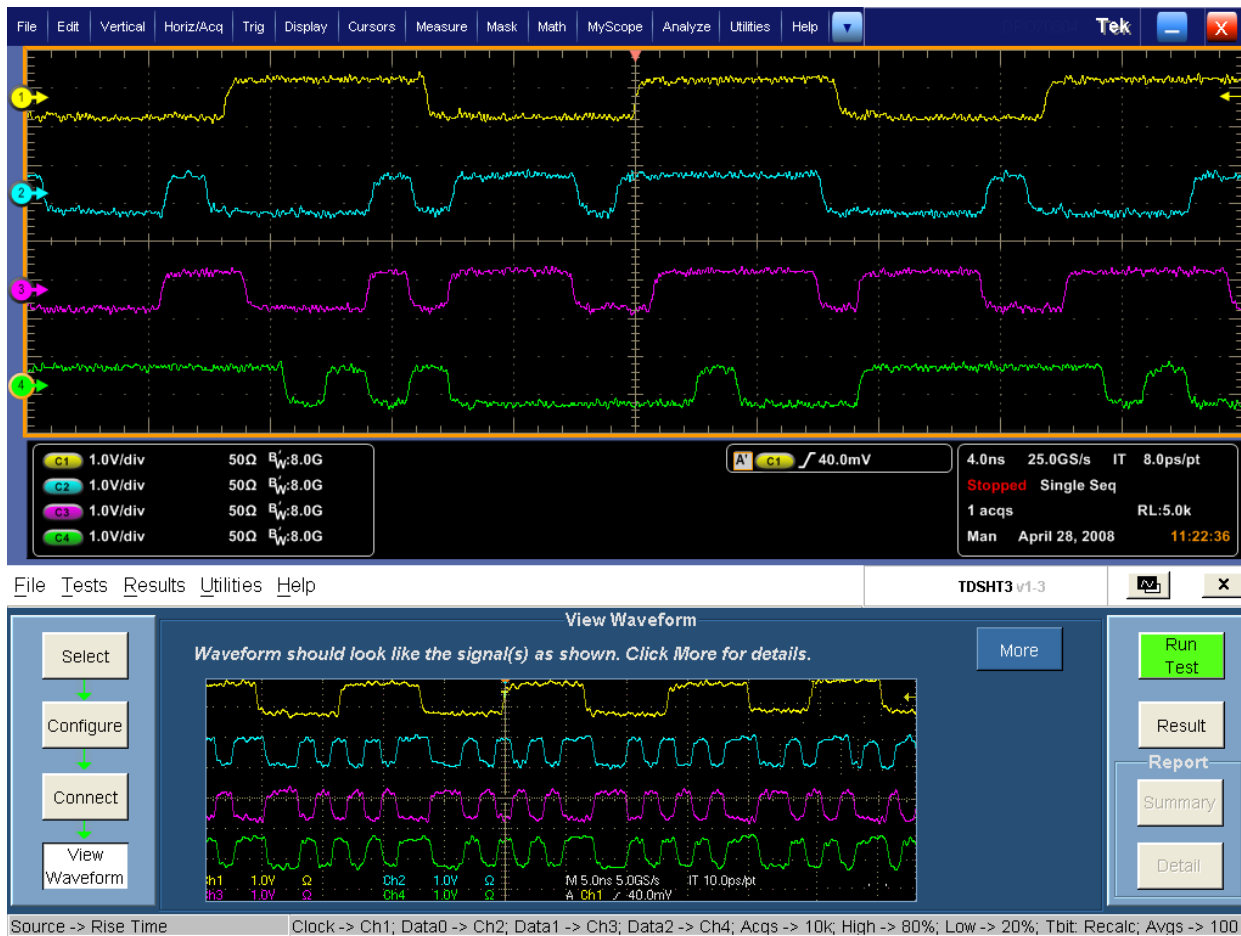

10. Click **Run Test** to perform the test. The TDSHT3 HDMI Compliance Test Software sets up the oscilloscope and the test runs, displaying a progress indicator.

11. The software makes Result available automatically and displays the result summary. You can also view the report configuration details in the result pane.

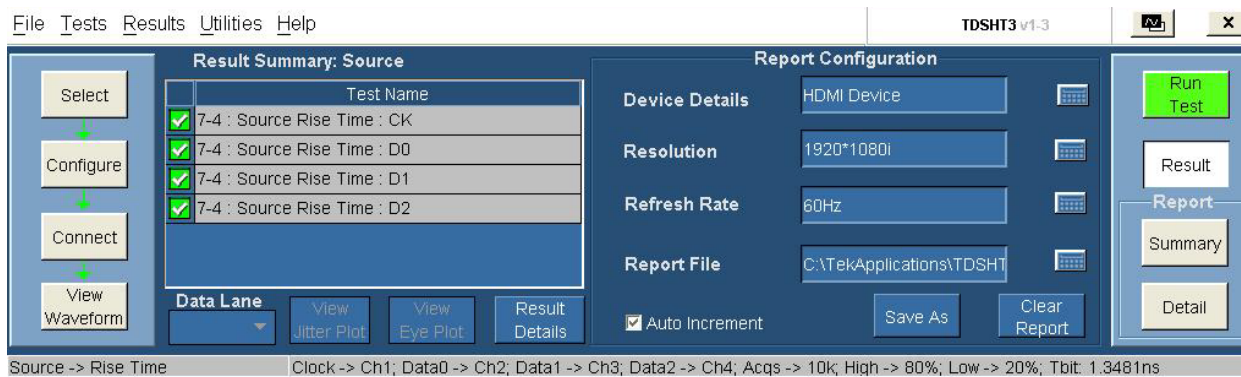

Option	Description
Test Name	The Test Name box displays the test id, test name, and selected lanes.
Status	Status indicates the status of the test as Pass, Fail, or Error.
Result Details	Click Result Details to display the details of the result.

12. You can set the report details to identify and generate the report automatically. You can set a default report file.

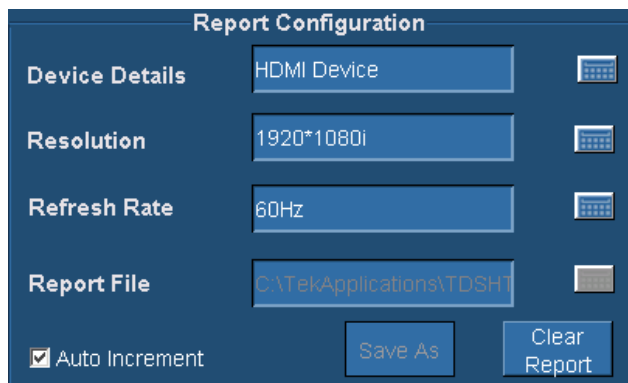

In the report configuration pane, you can configure the following parameters:

Category	Description
Device Details	The Device Details box allows you to specify the device-related information on which the test is conducted.
Resolution	The Resolution box allows you to specify the resolution on which the test is conducted.
Refresh Rate	The Refresh Rate box allows you to specify the refresh rate at which the test is conducted.
Report File	The Report File box allows you to specify the path and the file where the generated report will be saved. However, a default file name and path already exists.
Auto Increment	Select the Auto Increment check box to generate a new report. Selecting this option does not overwrite the existing report. However, it adds the date and time to the existing file name.
Save As	Click Save As to save the generated reports. The Save File dialog box is displayed. You can enter a file name and save the report.
Clear Report	Click Clear Report to clear all the results and records of the earlier tests.

13. In the result summary pane, click **Result Details** to display the details of the result.

Test Name	Spec Range	Meas Value	Result	Remarks/Comments
7-4 : Source Rise Time : CK	75.00ps < TRISE;	165.07ps	Pass	Tbit = 1.3481ns; Vs = 971.52mV; Margin = 90.07ps;
7-4 : Source Rise Time : D0	75.00ps < TRISE;	163.93ps	Pass	Tbit = 1.3481ns; Vs = 980.40mV; Margin = 88.93ps;
7-4 : Source Rise Time : D1	75.00ps < TRISE;	162.06ps	Pass	Tbit = 1.3481ns; Vs = 972.40mV; Margin = 87.06ps;
7-4 : Source Rise Time : D2	75.00ps < TRISE;	152.89ps	Pass	Tbit = 1.3481ns; Vs = 951.60mV; Margin = 77.89ps;

Buttons: Close, View Jitter Plot, View Eye Plot, Result Statistics

Options	Description
Test Name	The Test Name column displays the test id, test name, and selected lanes.
Spec Range	The Spec Range column displays the lower limit and upper limit of the rise time test.
Meas Value	The Meas Value column displays the measured value.
Result	The Result column displays the status of the test as Pass, Fail, or Error.
Remarks/Comments	The Remarks/Comments column displays the relevant details, for example, Tbit, Vswing, Upper Margin, and Lower Margin. If the test could not be run, then an error code appears.
Close	Click Close to quit the Result Details dialog box.
Result Statistics	Click Result Statistics to display statistics based on the tests.

14. In the Result Details dialog box, click **Result Statistics** to display statistics based on the tests.

Test Name	Population	Min	Max	Mean	Std Dev	Pk-Pk
7-4 : Source Rise Time : CK	86.958k	164.82ps	165.43ps	165.07ps	137.77fs	604.30fs
7-4 : Source Rise Time : D0	83.714k	163.41ps	164.36ps	163.93ps	217.50fs	953.80fs
7-4 : Source Rise Time : D1	83.848k	161.67ps	163.18ps	162.06ps	409.13fs	1.5153ps
7-4 : Source Rise Time : D2	83.827k	152.61ps	153.13ps	152.89ps	120.71fs	520.60fs

Button: Close

The software calculates statistics for each selected test, and logs the statistics on a cycle-by-cycle basis in a large waveform. The standard statistics are for the Maximum, Minimum, Mean, Standard Deviation, and Population.

Options	Description
Test Name	The Test Name column displays the test id, test name, and selected lanes.
Population	The software calculates this statistic by using the following equation: Population (X) = N
Min	The software calculates this statistic by using the following equation: Min (X) = Lowest value of X
Max	The software calculates this statistic by using the following equation: Max (X) = Highest value of X
Mean	The software calculates this statistic by using the following equation: $Mean (X) = \bar{X} = \frac{1}{N} \sum_{n=1}^N X_n$
Std Dev	The software calculates this statistic by using the following equation: $Standard\ Deviation (X) = \sigma_x = \sqrt{\frac{1}{(N-1)} \sum_{n=1}^N (X_n - \bar{X})^2}$
Pk-Pk	The software calculates this statistic by using the following equation: Xppn = Max(X) – Min(X)
Close	Click Close to quit the Result Statistics dialog box.

Fall Time

This test allows you to confirm that the fall times on the TMDS differential signals fall within the limits of the specification.

You will need one supported oscilloscope, one differential probe, one DC power supply 3.3 V, one EDID emulator, and one TPA-P fixture.

NOTE. For the DPO/DSA70000 series oscilloscopes with P7313 SMA probes and Efficere fixtures, you have the option to set the probe control voltage to **internal** from the [Preferences](#) menu. If this option is selected, an external power supply is not required.

1. On the menu bar, click **Tests > Select > Source**.

- In the differential tests pane, select the Fall Time check box.

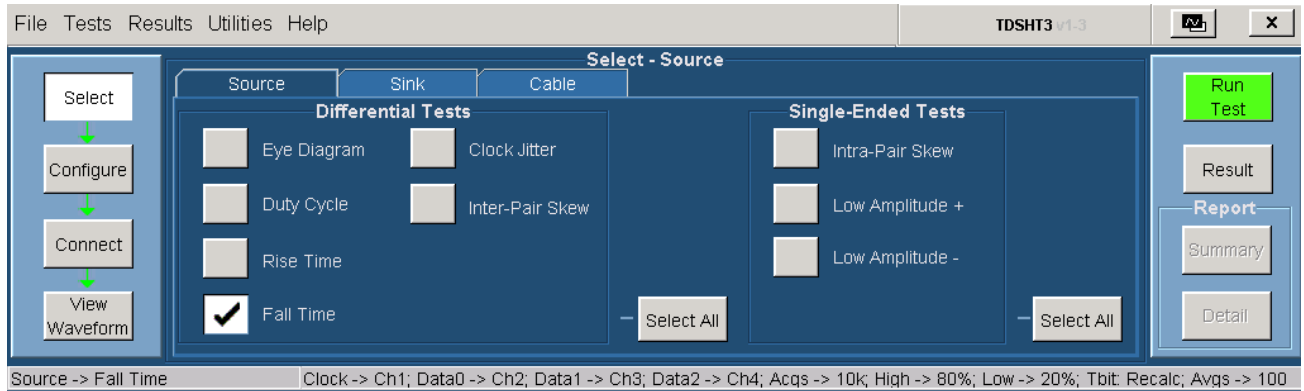

- To change the configuration settings, click **Tests > Configure**. For most tests, you can use the factory default configuration. However, you can change the values by using the [virtual keyboard](#) or the [general purpose knob](#) on the oscilloscope front panel. Using the File menu, you can also restore the factory defaults or save and recall your own configuration settings. It is recommended that you save the configuration settings before you choose to select Recall Default or close the application.

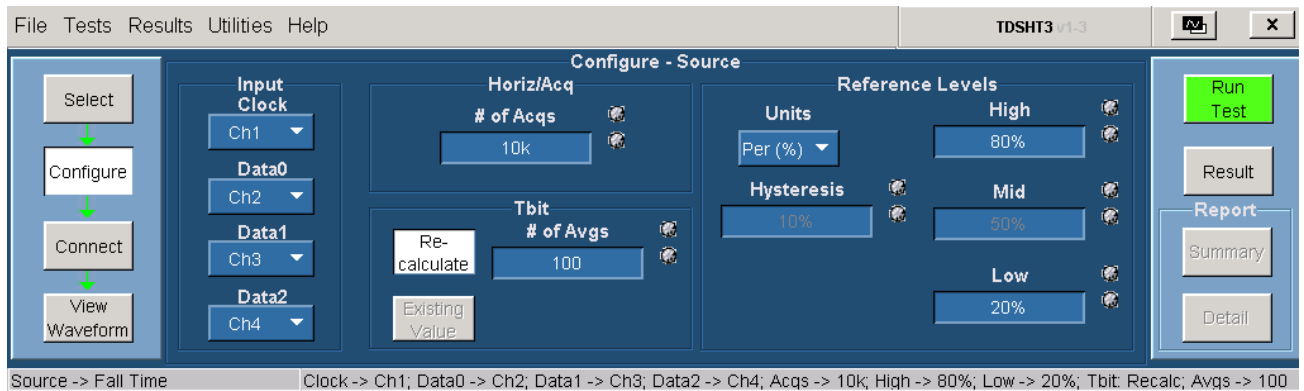

- In the input pane, you have the following options:

Configure parameter	Description
Clock	Clock indicates the source channel to which you will connect the HDMI clock input lane. The available choices are Ch1, Ch2, Ch3, Ch4, and Not Conn.
Data0	Data0 indicates the source channel to which you will connect the HDMI data0 input lane. The available choices are Ch1, Ch2, Ch3, Ch4, and Not Conn.

Configure parameter	Description
Data1	Data1 indicates the source channel to which you will connect the HDMI data1 input lane. The available choices are Ch1, Ch2, Ch3, Ch4, and Not Conn.
Data2	Data2 indicates the source channel to which you will connect the HDMI data2 input lane. The available choices are Ch1, Ch2, Ch3, Ch4, and Not Conn.

5. In the horiz/acq pane, you have the following option:

Configure parameter	Description
# of Acqs	In the # of Acqs box, enter the desired number of acquisitions that are required for the test. The default value is 10 K.

6. In the tbit pane, you have the following options:

Configure parameter	Description
# of Avgs	In the # of Avgs box, enter the desired number of periods that are considered to calculate Tbit. The default value is 100.
Re-calculate	Click Re-calculate to recalculate the Tbit value.
Existing Value	Click Existing Value to use the previously calculated Tbit value.

7. In the reference levels pane, you have the following options:

Configure parameter	Description
Units	The Units list allows you to set the reference level units to either Per (%) or Abs. Per (%) indicates that the reference levels are a percentage of the Vswing value. Abs indicates that the reference levels are absolute voltage values.
Hysteresis	In the Hysteresis box, enter the desired hysteresis percent value. The default value is 10 percent.
High	In the High box, enter the desired high reference voltage value. The default value is 80 percent.
Mid	In the Mid box, enter the desired mid reference voltage value. The default value is 50 percent.
Low	In the Low box, enter the desired low reference voltage value. The default value is 20 percent.

8. To connect the DUT, click **Tests > Connect**. [Click here](#) for information on how to make connections.

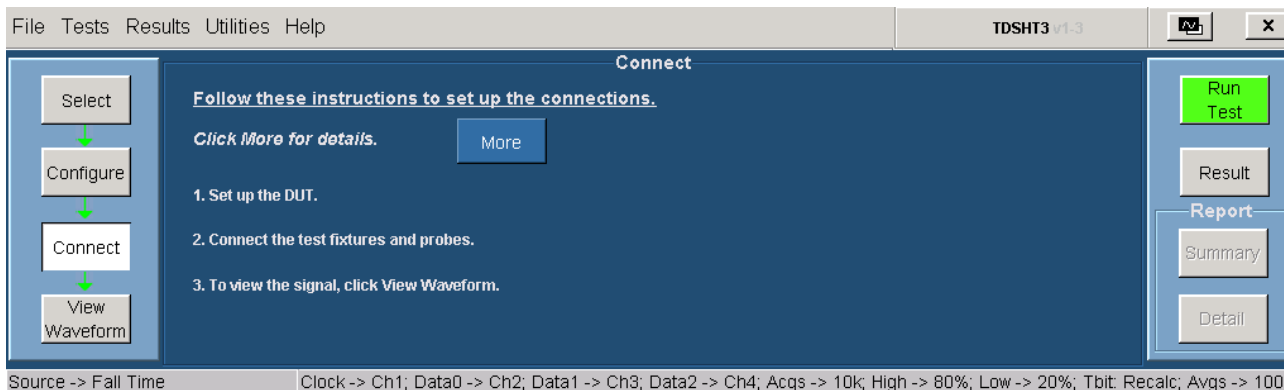

- 9. Ensure that your signal in the oscilloscope display is similar to the sample signal. Click **View Waveform** to display a sample of the expected signal. If the displays are not similar, go back and check your configuration and connections.

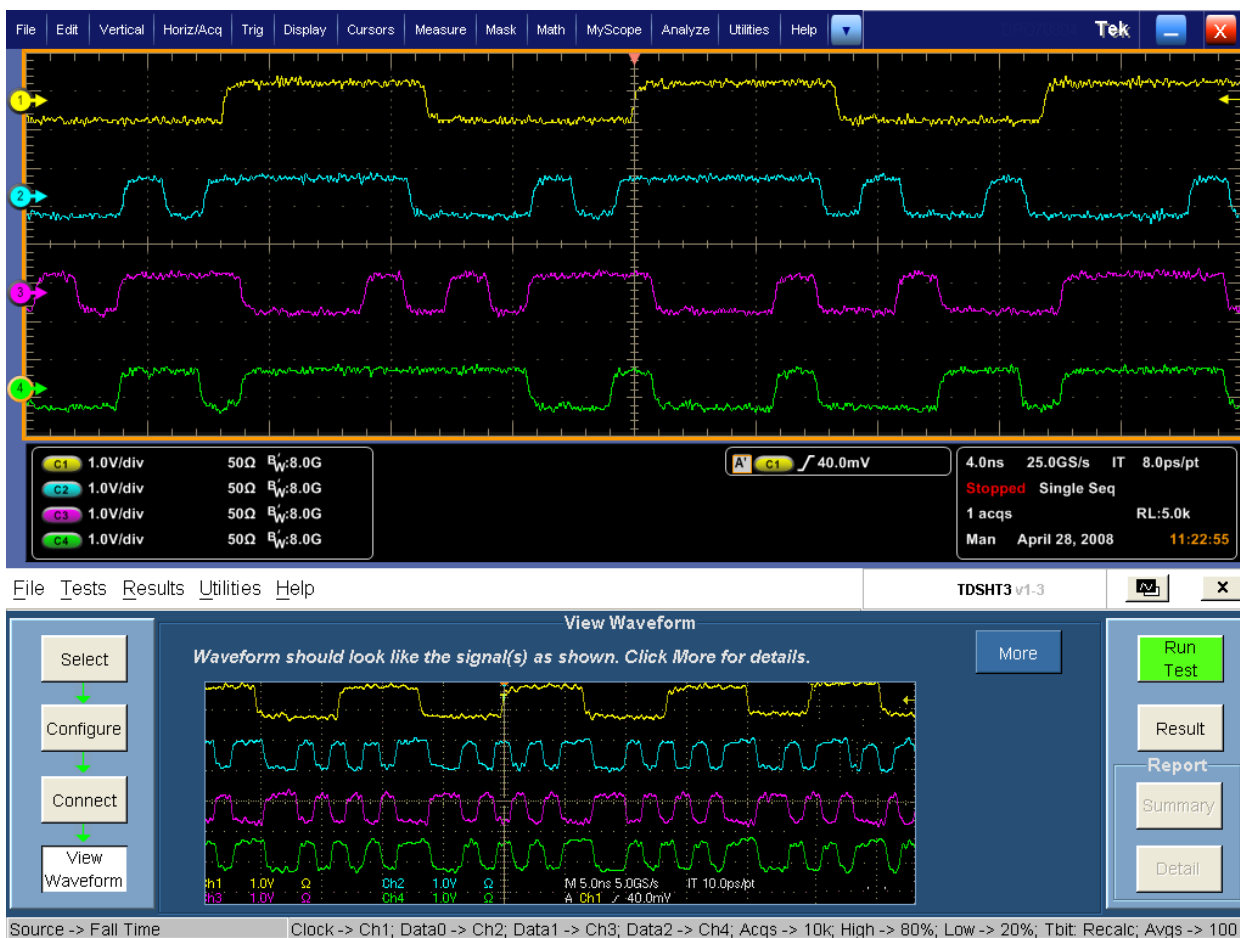

- 10. Click **Run Test** to perform the test. The TDSHT3 HDMI Compliance Test Software sets up the oscilloscope and the test runs, displaying a progress indicator.

11. The software makes Result available automatically and displays the result summary. You can also view the report configuration details in the result pane.

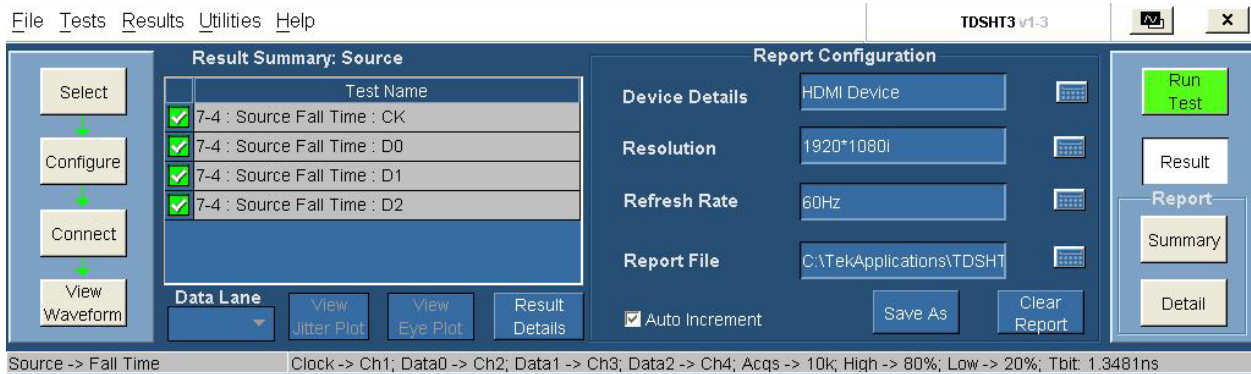

Option	Description
Test Name	The Test Name box displays the test id, test name, and selected lanes.
Status	Status indicates the status of the test as Pass, Fail, or Error.
Result Details	Click Result Details to display the details of the result.

12. You can set the report details to identify and generate the report automatically. You can set a default report file.

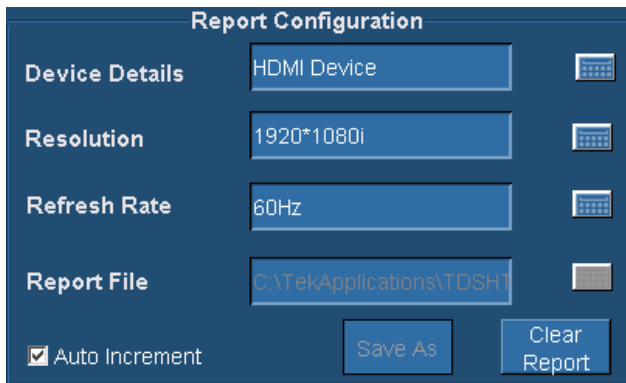

In the report configuration pane, you can configure the following parameters:

Category	Description
Device Details	The Device Details box allows you to specify the device-related information on which the test is conducted.
Resolution	The Resolution box allows you to specify the resolution on which the test is conducted.
Refresh Rate	The Refresh Rate box allows you to specify the refresh rate at which the test is conducted.

Category	Description
Report File	The Report File box allows you to specify the path and the file where the generated report will be saved. However, a default file name and path already exists.
Auto Increment	Select the Auto Increment check box to generate a new report. Selecting this option does not overwrite the existing report. However, it adds the date and time to the existing file name.
Save As	Click Save As to save the generated reports. The Save File dialog box is displayed. You can enter a file name and save the report.
Clear Report	Click Clear Report to clear all the results and records of the earlier tests.

13. In the result summary pane, click **Result Details** to display the details of the result.



Options	Description
Test Name	The Test Name column displays the test id, test name, and selected lanes.
Spec Range	The Spec Range column displays the lower limit and upper limit of the fall time test.
Meas Value	The Meas Value column displays the measured value.
Result	The Result column displays the status of the test as Pass, Fail, or Error.
Remarks/Comments	The Remarks/Comments column displays the relevant details, for example, Tbit, Vswing, Upper Margin, and Lower Margin. If the test could not be run, then an error code appears.
Close	Click Close to quit the Result Details dialog box.
Result Statistics	Click Result Statistics to display statistics based on the tests.

14. In the Result Details dialog box, click **Result Statistics** to display statistics based on the tests.

Test Name	Population	Min	Max	Mean	Std Dev	PK-Pk
7-4 : Source Fall Time : CK	86.963k	161.26ps	162.31ps	162.08ps	218.94fs	1.0496ps
7-4 : Source Fall Time : D0	83.693k	157.15ps	157.66ps	157.46ps	150.67fs	509.50fs
7-4 : Source Fall Time : D1	83.861k	157.36ps	158.06ps	157.79ps	203.08fs	699.00fs
7-4 : Source Fall Time : D2	83.837k	138.87ps	139.36ps	138.99ps	131.97fs	490.90fs

Close

The software calculates statistics for each selected test, and logs the statistics on a cycle-by-cycle basis in a large waveform. The standard statistics are for the Maximum, Minimum, Mean, Standard Deviation, and Population.

Options	Description
Test Name	The Test Name column displays the test id, test name, and selected lane.
Population	The software calculates this statistic by using the following equation: Population (X) = N
Min	The software calculates this statistic by using the following equation: Min (X) = Lowest value of X
Max	The software calculates this statistic by using the following equation: Max (X) = Highest value of X
Mean	The software calculates this statistic by using the following equation: $Mean (X) = \bar{X} = \frac{1}{N} \sum_{n=1}^N X_n$
Std Dev	The software calculates this statistic by using the following equation: $Standard Deviation (X) = \sigma_x = \sqrt{\frac{1}{(N-1)} \sum_{n=1}^N (X_n - \bar{X})^2}$
Pk-Pk	The software calculates this statistic by using the following equation: Xppn = Max(X) – Min(X)
Close	Click Close to quit the Result Statistics dialog box.

Clock Jitter

This test allows you to confirm that the TMDS clock does not carry excessive jitter.

You will need one supported oscilloscope, one differential probe, one DC power supply 3.3 V, one EDID emulator, and one TPA-P fixture.

NOTE. For the DPO/DSA70000 series oscilloscopes with P7313 SMA probes and Efficere fixtures, you have the option to set the probe control voltage to **internal** from the [Preferences](#) menu. If this option is selected, an external power supply is not required.

1. On the menu bar, click **Tests > Select > Source**.
2. In the differential tests pane, select the Clock Jitter check box.

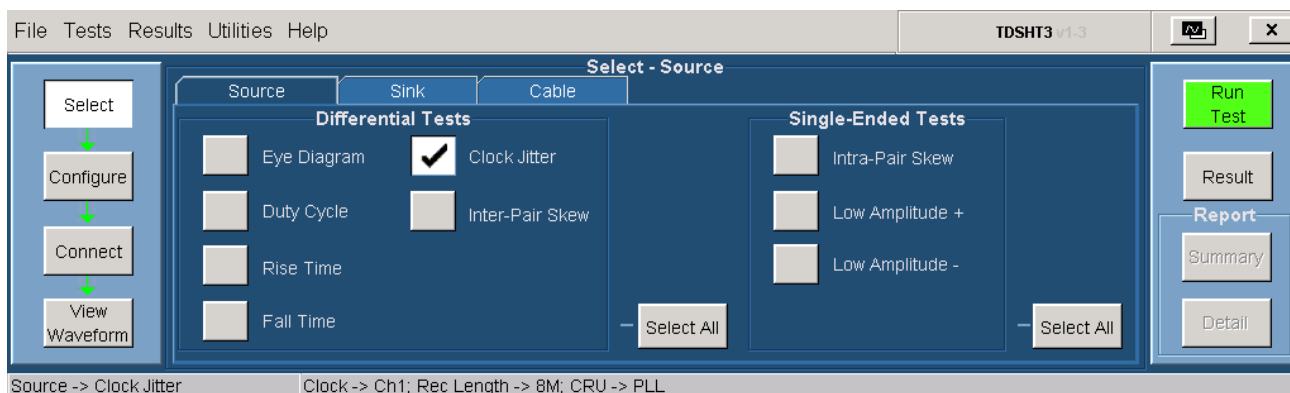

3. To change the configuration settings, click **Tests > Configure**. For most tests, you can use the factory default configuration. However, you can change the values by using the virtual keyboard or the general-purpose knob on the oscilloscope front panel. Using the File menu, you can also restore the factory defaults or save and recall your own configuration settings. It is recommended that you save the configuration settings before you choose to select Recall Default or close the application.

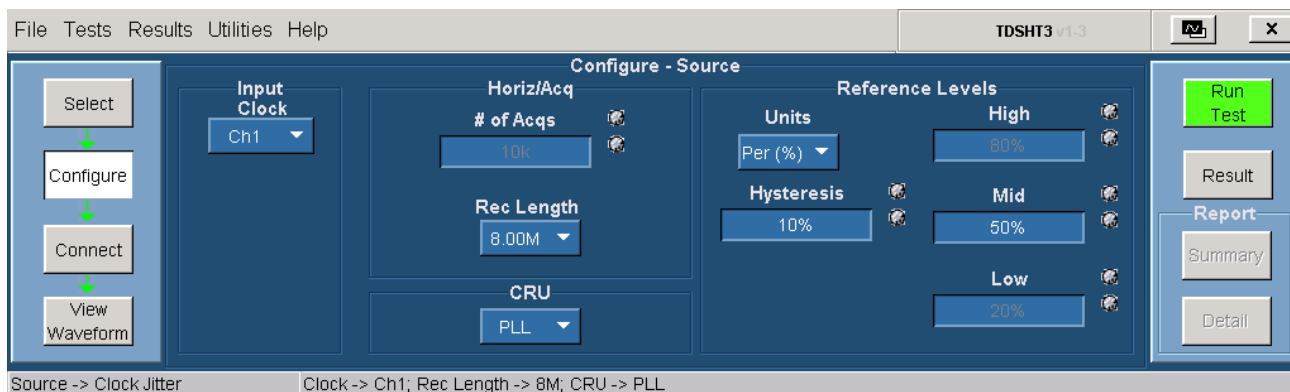

4. In the input pane, you have the following option:

Configure parameter	Description
Clock	Clock indicates the source channel to which you will connect the HDMI clock input lane. The available choices are Ch1, Ch2, Ch3, Ch4, Ref1, Ref2, Ref3, and Ref4.

5. In the horiz/acq pane, you have the following option:

Configure parameter	Description
Record Length	In the Rec Length box, enter the desired record length value for the clock jitter tests.

6. In the CRU pane, you have the following option:

Configure parameter	Description
CRU	The CRU list allows you to configure the Clock Recovery Unit. The available choices are PLL, Raw, and Ideal. The default value is first order PLL and is used for compliance testing. Raw and Ideal are used for analysis.

7. In the reference levels pane, you have the following options:

Configure parameter	Description
Units	The Units list allows you to set the reference level units to either Per (%) or Abs. Per (%) indicates that the reference levels are a percentage of the Vswing value. Abs indicates that the reference levels are absolute voltage values.
Hysteresis	In the Hysteresis box, enter the desired hysteresis percent value. The default value is 10 percent.
Mid	In the Mid box, enter the desired mid reference voltage value. The default value is 50 percent.

8. To connect the DUT, click **Tests > Connect**. [Click here](#) for information on how to make connections.

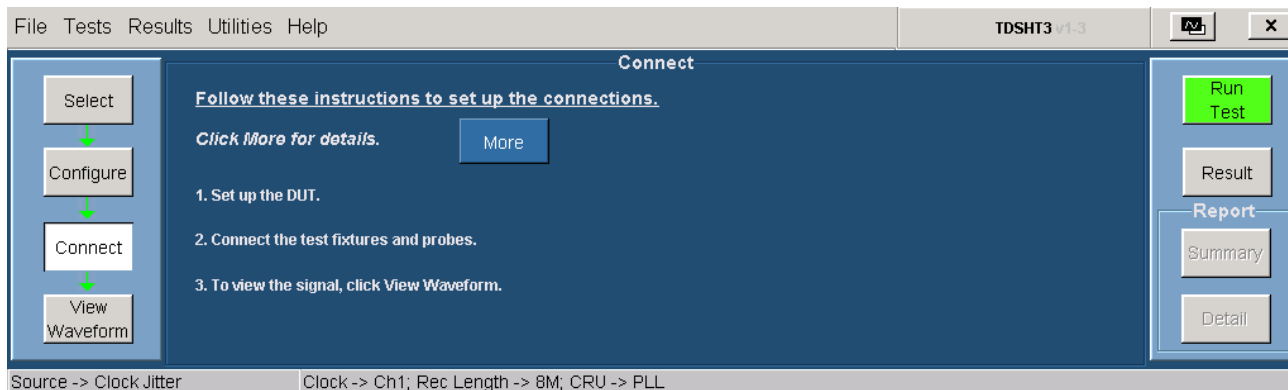

9. Ensure that your signal in the oscilloscope display is similar to the sample signal. Click **View Waveform** to display a sample of the expected signal. If the displays are not similar, go back and check your configuration and connections.
10. Click **Run Test** to perform the test. The TDSHT3 HDMI Compliance Test Software sets up the oscilloscope and the test runs, displaying a progress indicator.
11. If you have run the clock jitter test successfully, the software makes Result available automatically and displays the clock jitter plot.

The clock jitter plot is as follows:

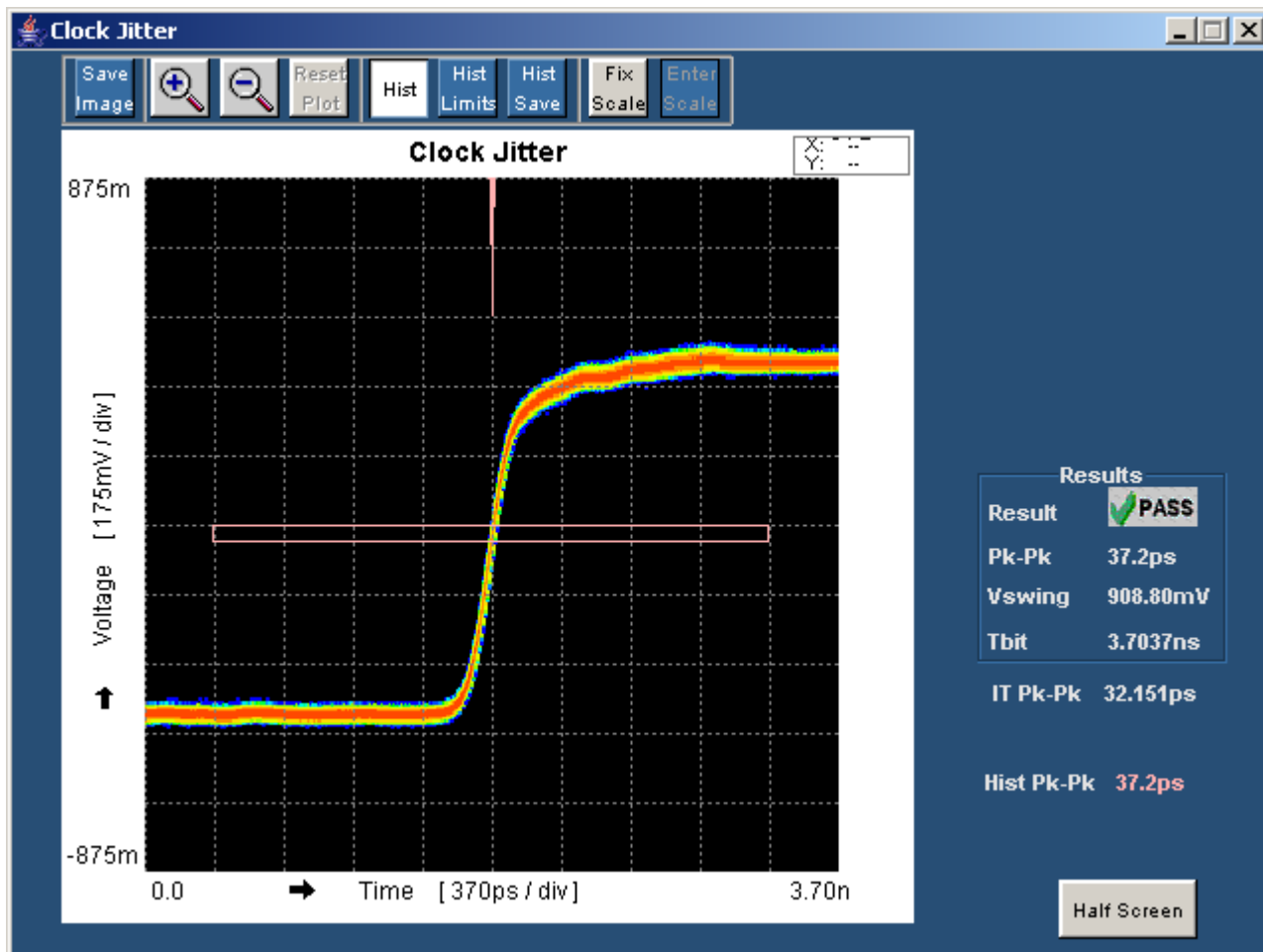

NOTE. In the full screen mode, the histogram disappears if you click anywhere within the plot.

- The name of the buttons available on the clock jitter plot and their descriptions are as follows:

Options	Description
Save Image	Click Save Image to save the clock jitter plot.
Zoom-In	Click the Zoom-In icon to zoom the area of interest. You can zoom up to five times the normal view. Either drag the mouse or click to zoom in to define the area of interest.
Zoom-Out	Click the Zoom-out icon to zoom out.
Reset Plot	Click Reset Plot to reset the plot.
Hist	Click Hist to draw the histogram.
Hist Limits	Click Hist Limits to draw the histogram box.
Hist Save	Click Hist Save to save the histogram.

Options	Description
Fix Scale	Click Fix Scale to allow the user to type a new scale value.
Enter Scale	Click Enter Scale to allow the user to type a new scale value in the Vertical Scale box.
Results pane	The results pane displays the result, Pk-Pk value, Vswing value, and the Tbit value. The IT Pk-Pk and the Hist Pk-Pk values are also shown near the results pane.
Half Screen	Click Half Screen to show the plot in half screen.
Full Screen	Click Full Screen to maximize the plot to full screen.

- Click **Hist** to draw the histogram on the eye diagram plot.
- Click **Hist Limits** to draw a histogram box.
- Double-click the buttons next to the Ymax, Ymin, Xmin, and Xmax labels to type the X and Y histogram limits.

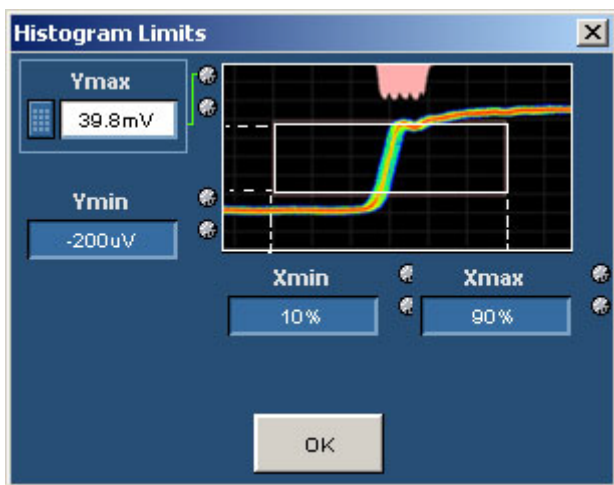

- The results pane displays the result, Pk-Pk value, Vswing value, and the Tbit value. The IT Pk-Pk and the Hist Pk-Pk values are also shown near the results pane. If there is no value for IT Pk-Pk, then it implies the absence of data points in the histogram window. In this case, increase the record length value and run the test again.

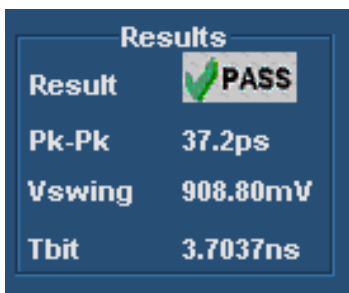

Result name	Description
Result	View the result of the test as Pass or Fail.
Pk-Pk	View the Pk-Pk value.
Vswing	View the voltage swing of the signal.
Tbit	View the time period of each bit.

12. Click **Half Screen** to view the clock jitter plot in half screen. You can also view both the result summary of the test and the report configuration in the result pane as shown in the following figure.

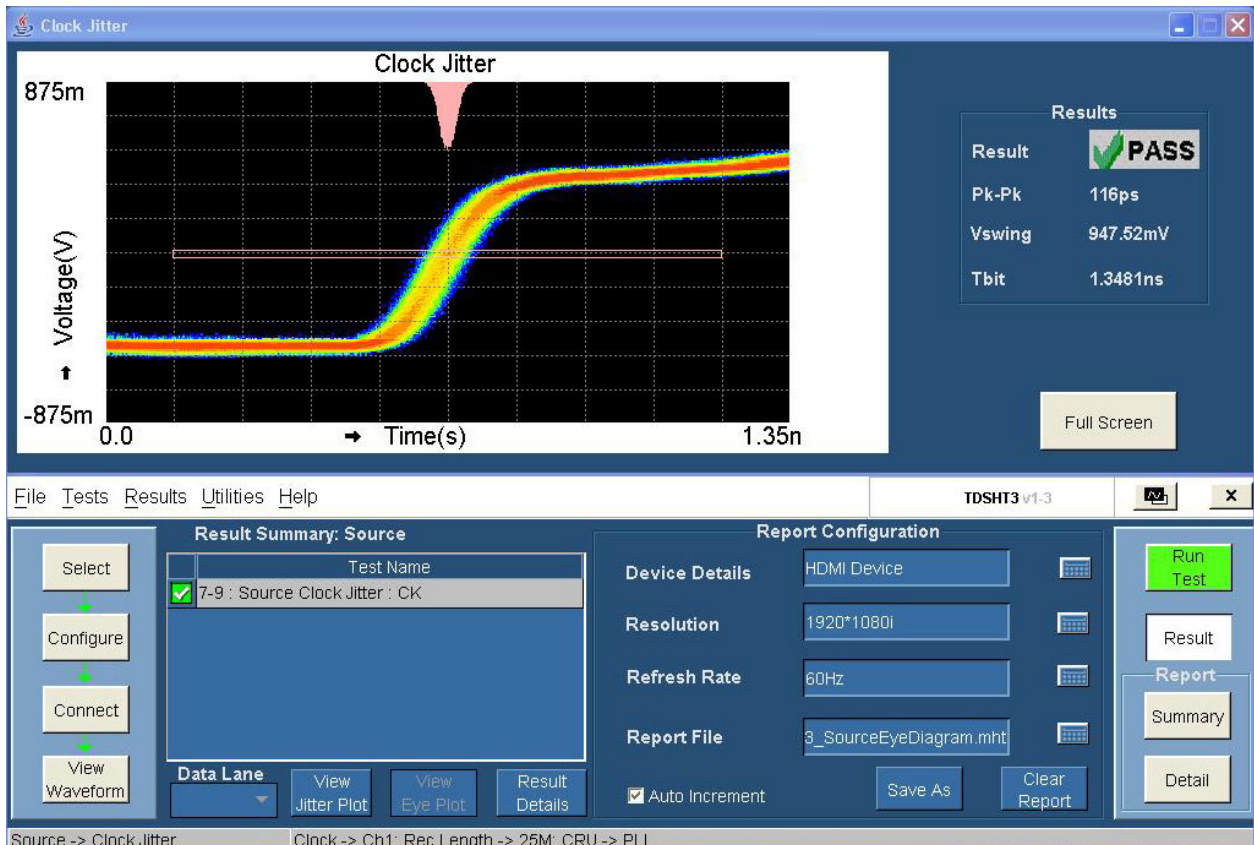



The result pane comprises both the result summary pane and the report configuration pane.

Result Summary pane

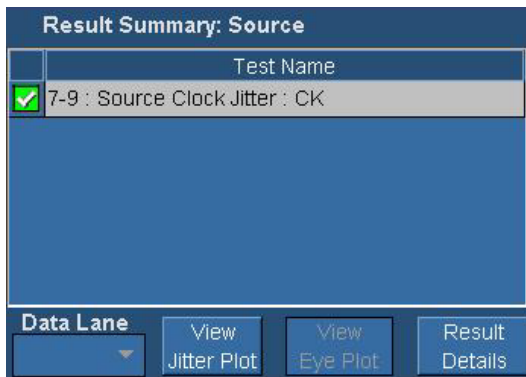
The result summary pane displays the test results.



-  This icon indicates that the test has passed.
-  This icon indicates that the test has failed.
-  This icon indicates that the test could not be run.

Options	Description
Test Name	The Test Name box displays the test id, test name, and selected lanes.
Status	The status icons display the status of the test as Pass, Fail, or Error.
View Jitter Plot	Click View Jitter Plot to display the jitter plot. This option is available if you have successfully run the clock jitter test.
Result Details	Click Result Details to display the Result Details dialog box that shows the details of the test results categorized as Test Name, Spec Range, Meas Value, Result, and Remarks/Comments.

Report Configuration pane

You can set the report details to identify and generate the report automatically. You can set a default report file.

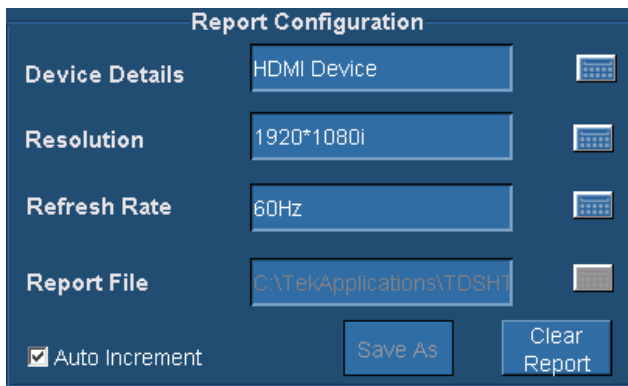

In the report configuration pane, you can configure the following parameters:

Category	Description
Device Details	The Device Details box allows you to specify the device-related information on which the test is conducted.
Resolution	The Resolution box allows you to specify the resolution on which the test is conducted.
Refresh Rate	The Refresh Rate box allows you to specify the refresh rate at which the test is conducted.
Report File	The Report File box allows you to specify the path and the file where the generated report will be saved. However, a default file name and path already exists.
Auto Increment	Select the Auto Increment check box to generate a new report. Selecting this option does not overwrite the existing report. However, it adds the date and time to the existing file name.
Save As	Click Save As to save the generated reports. The Save File dialog box is displayed. You can enter a file name and save the report.
Clear Report	Click Clear Report to clear all the results and records of the earlier tests.

13. In the result summary pane, click **Result Details** to display the details of the result.



Options	Description
Test Name	The Test Name column displays the test id, test name, and selected lanes.
Spec Range	The Spec Range column describes the HDMI standards and test specifications limit for the test.
Meas Value	The Meas Value column displays the measured value.
Result	The Result column displays the status of the test as Pass, Fail, or Error.

Options	Description
Remarks/Comments	The Remarks/Comments column displays the results of Tbit, Vswing, and Margin. If the test could not be run, then an error code appears.
Close	Click Close to quit the Result Details dialog box.
View Jitter Plot	Click View Jitter Plot to display the jitter plot. This option is available if you have successfully run the clock jitter test.
Result Statistics	Click Result Statistics to display statistics based on the tests.

14. In the Result Details dialog box, click **Result Statistics** to display statistics based on the tests.

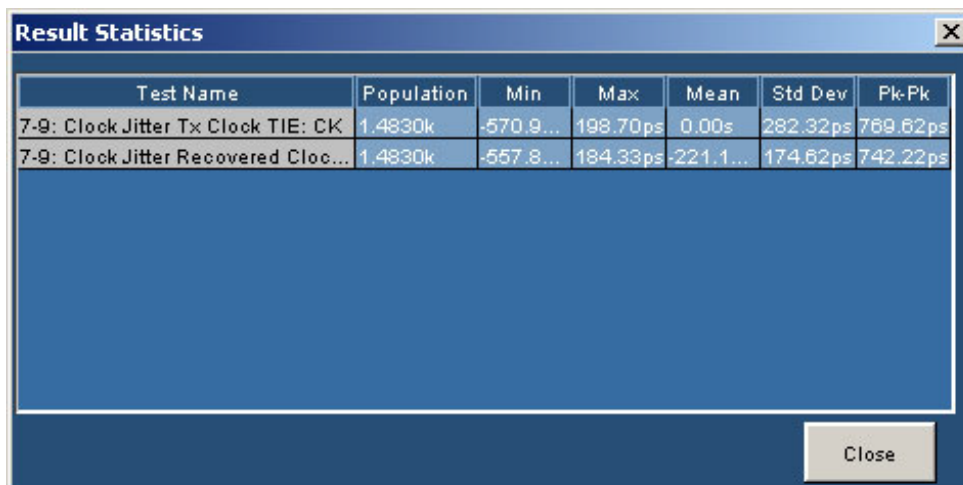

The software calculates statistics for each selected test, and logs the statistics on a cycle-by-cycle basis in a large waveform. The standard statistics are for the Maximum, Minimum, Mean, Standard Deviation, and Population.

Options	Description
Test Name	The Test Name column displays the test id, test name, and selected lanes.
Population	The software calculates this statistic by using the following equation: Population (X) = N
Min	The software calculates this statistic by using the following equation: Min (X) = Lowest value of X
Max	The software calculates this statistic by using the following equation: Max (X) = Highest value of X

Options	Description
Mean	The software calculates this statistic by using the following equation: $\text{Mean } (X) = \bar{X} = \frac{1}{N} \sum_{n=1}^N X_n$
Std Dev	The software calculates this statistic by using the following equation: $\text{Standard Deviation } (X) = \sigma_x = \sqrt{\frac{1}{(N-1)} \sum_{n=1}^N (X_n - \bar{X})^2}$
Pk-Pk	The software calculates this statistic by using the following equation: $X_{ppn} = \text{Max}(X) - \text{Min}(X)$
Close	Click Close to quit the Result Statistics dialog box.

Inter-Pair Skew

This test allows you to confirm that any skew between the differential pairs in the TMDS portion of the HDMI link does not exceed the limits in the specification.

You will need one supported oscilloscope, two/four differential probes, one DC power supply 3.3 V, one EDID emulator, and one TPA-P fixture.

NOTE. For the DPO/DSA70000 series oscilloscopes with P7313 SMA probes and Efficere fixtures, you have the option to set the probe control voltage to **internal** from the [Preferences](#) menu. If this option is selected, an external power supply is not required.

NOTE. [Deskew](#) is recommended before you conduct any skew test.

1. On the menu bar, click **Tests > Select > Source**.
2. In the differential tests pane, select the Inter-Pair Skew check box.

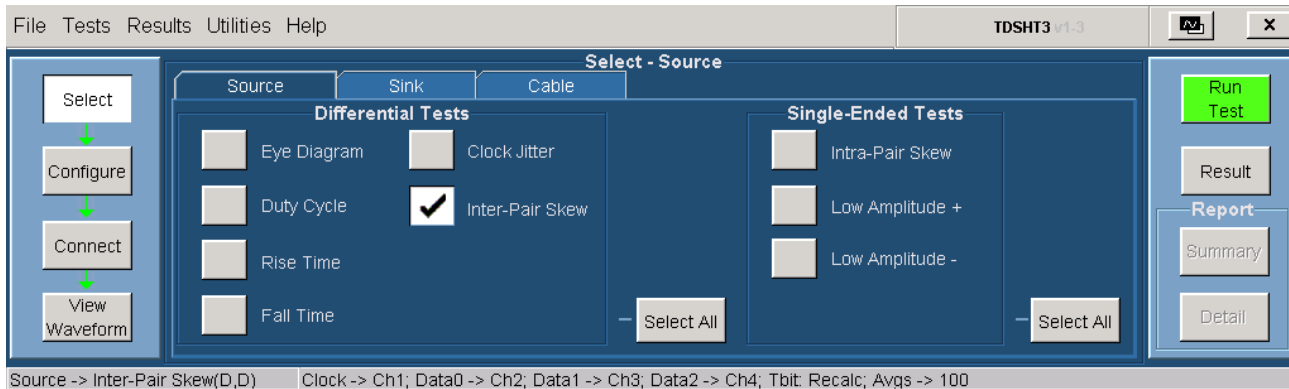

3. To change the configuration settings, click **Tests > Configure**. For most tests, you can use the factory default configuration. However, you can change the values by using the [virtual keyboard](#) or the [general purpose knob](#) on the oscilloscope front panel. Using the File menu, you can also restore the factory defaults or save and recall your own configuration settings. It is recommended that you save the configuration settings before you choose to select Recall Default or close the application.

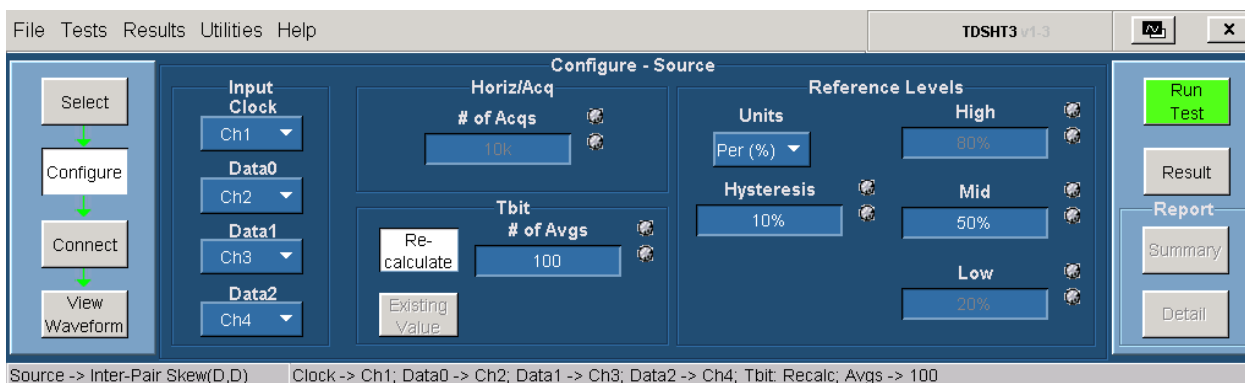

For 2-Channel setup, the configuration is as follows:

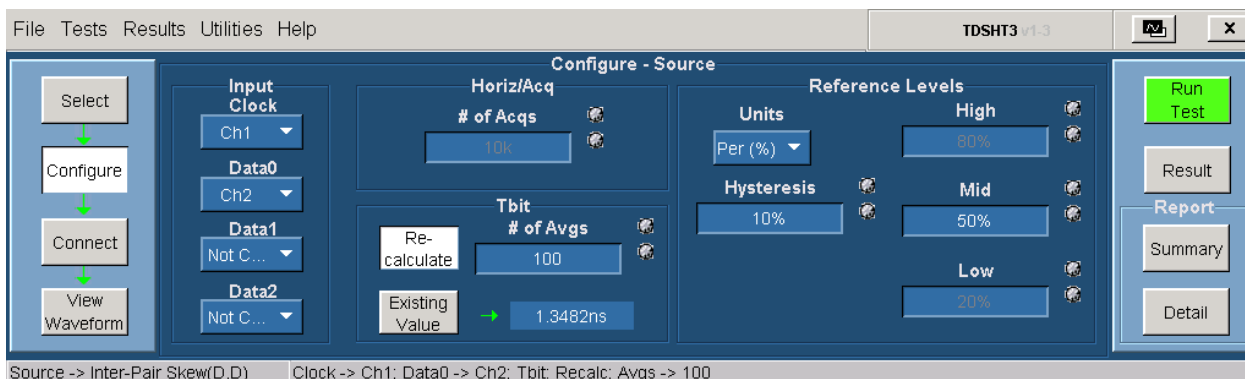

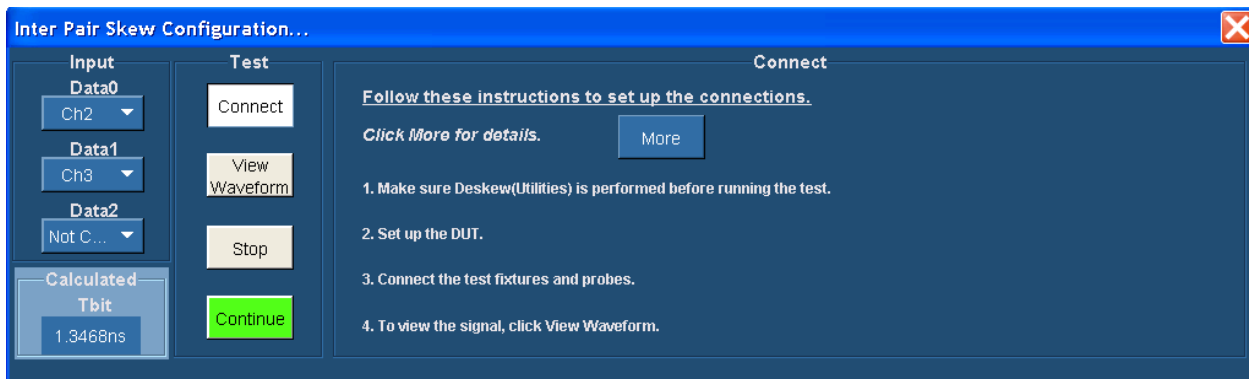

Remove the clock signal connection and connect the data pair between which you want to calculate the skew.

4. In the input pane, you have the following options:

Configure parameter	Description
Clock	Clock indicates the source channel to which you will connect the HDMI clock input lane. The available choices are Ch1, Ch2, Ch3, and Ch4.
Data0	Data0 indicates the source channel to which you will connect the HDMI data0 input lane. The available choices are Ch1, Ch2, Ch3, Ch4, and Not Conn.
Data1	Data1 indicates the source channel to which you will connect the HDMI data1 input lane. The available choices are Ch1, Ch2, Ch3, Ch4, and Not Conn.
Data2	Data2 indicates the source channel to which you will connect the HDMI data2 input lane. The available choices are Ch1, Ch2, Ch3, Ch4, and Not Conn.

5. In the tbit pane, you have the following options:

Configure parameter	Description
# of Avgs	In the # of Avgs box, enter the desired number of periods that are considered to calculate Tbit. The default value is 100.
Re-calculate	Click Re-calculate to recalculate the Tbit value.
Existing Value	Click Existing Value to use the previously calculated Tbit value.

6. In the reference levels pane, you have the following options:

Configure parameter	Description
Units	The Units list allows you to set the reference level units to either Per (%) or Abs. Per (%) indicates that the reference levels are a percentage of the Vswing value. Abs indicates that the reference levels are absolute voltage values.
Hysteresis	In the Hysteresis box, enter the desired hysteresis percent value. The default value is 10 percent.
Mid	In the Mid box, enter the desired mid reference voltage value. The default value is 50 percent.

7. To connect the DUT, click **Tests > Connect**. [Click here](#) for information on how to make connections.

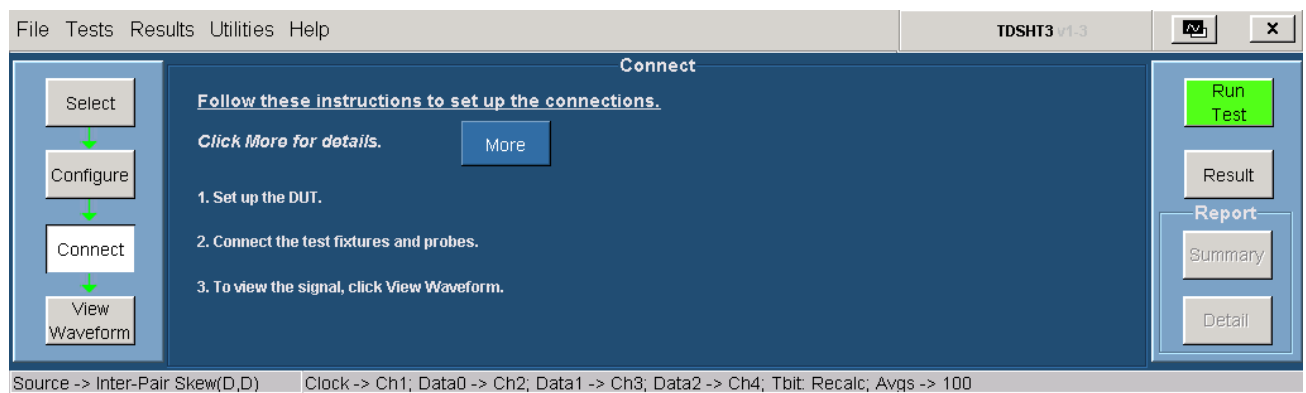

8. Ensure that your signal in the oscilloscope display is similar to the sample signal. Click **View Waveform** to display a sample of the expected signal. If the displays are not similar, go back and check your configuration and connections. The waveform shown here is for the re-calculate Tbit option. Click **Run Test** to run the test. The Confirm dialog box appears. Click **Continue** to continue to run the test. Go to step 10.

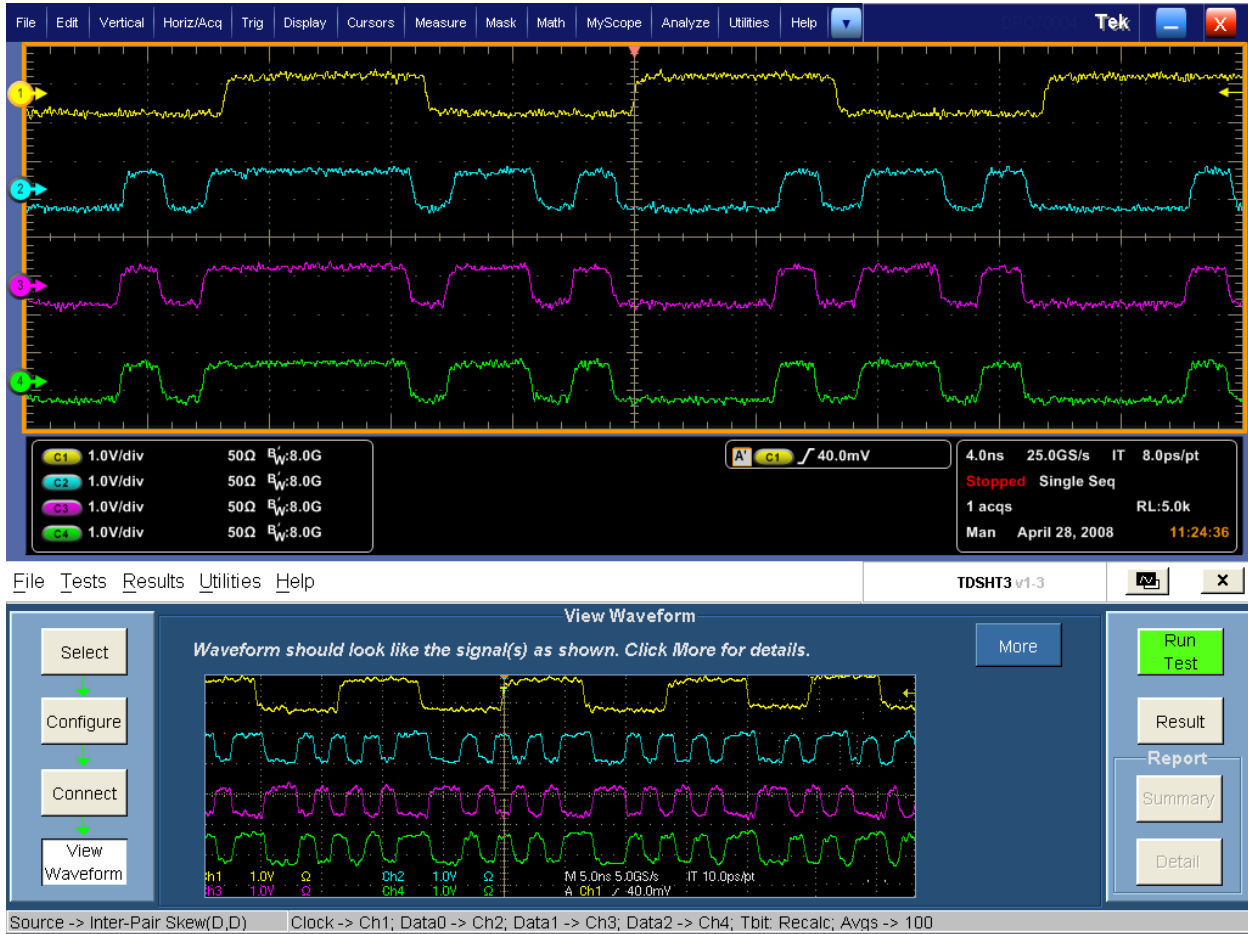

9. If you have selected existing Tbit value, then click **View Waveform** to get a different waveform on your display. Ensure that your signal in the oscilloscope display is similar to the sample signal.
10. Click **Run Test** to run the test. The TDSHT3 HDMI Compliance Test Software sets up the oscilloscope and the test runs, displaying a progress indicator.
11. The software makes Result available automatically and displays the result summary. You can also view the report configuration details in the result pane.

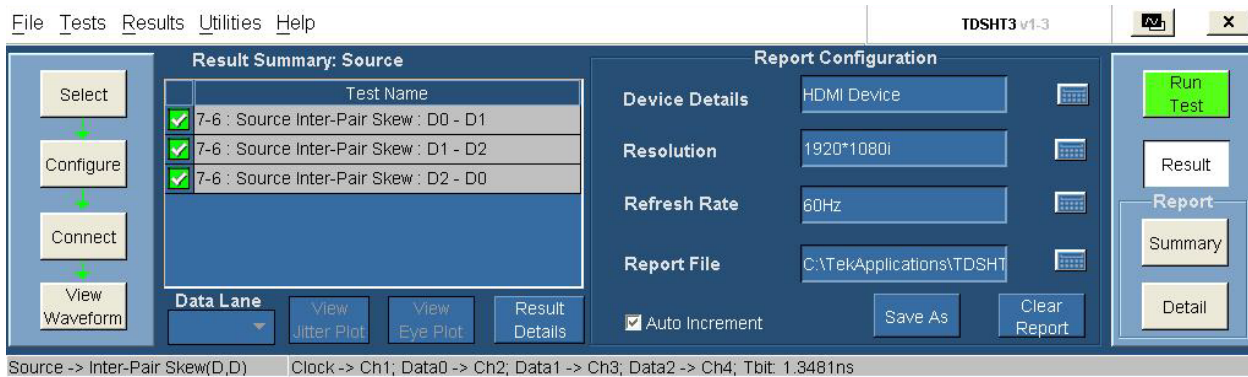

Option	Description
Test Name	The Test Name box displays the test id, test name, and selected lanes.
Status	Status indicates the status of the test as Pass, Fail, or Error.
Result Details	Click Result Details to display the details of the result.

12. You can set the report details to identify and generate the report automatically. You can set a default report file.

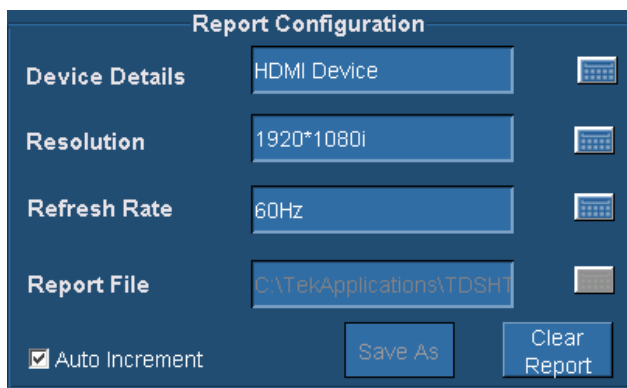

In the report configuration pane, you can configure the following parameters:

Category	Description
Device Details	The Device Details box allows you to specify the device-related information on which the test is conducted.
Resolution	The Resolution box allows you to specify the resolution on which the test is conducted.
Refresh Rate	The Refresh Rate box allows you to specify the refresh rate at which the test is conducted.
Report File	The Report File box allows you to specify the path and the file where the generated report will be saved. However, a default file name and path already exists.
Auto Increment	Select the Auto Increment check box to generate a new report. Selecting this option does not overwrite the existing report. However, it adds the date and time to the existing file name.
Save As	Click Save As to save the generated reports. The Save File dialog box is displayed. You can enter a file name and save the report.
Clear Report	Click Clear Report to clear all the results and records of the earlier tests.

13. In the result summary pane, click **Result Details** to display the details of the result.

Test Name	Spec Range	Meas Value	Result	Remarks/Comments
7-6 : Source Inter-Pair Skew : D0 - D1	Skew < 200.0ms;	0.011s	Pass	Tbit = 1.3481ns; Vs(D0 - D1) = = 985.76mV, Vs = 982.08mV; Min = 137.39p, Max = 149.23p; Avg = 141.93p;
7-6 : Source Inter-Pair Skew : D1 - D2	Skew < 200.0ms;	0s	Pass	Tbit = 1.3481ns; Vs(D1 - D2) = = 982.08mV, Vs = 984.92mV; Min = 735.79f, Max = 11.212p; Avg = 6.2377p;
7-6 : Source Inter-Pair Skew : D2 - D0	Skew < 200.0ms;	0.01s	Pass	Tbit = 1.3481ns; Vs(D2 - D0) = = 964.92mV, Vs = 985.76mV; Min = 129.81p, Max = 148.60p; Avg = 135.26p;

Options	Description
Test Name	The Test Name column displays the test id, test name, and selected lanes.
Spec Range	The Spec Range column displays the HDMI standards and test specifications limit for the test.
Meas Value	The Meas Value column displays the measured value.
Result	The Result column displays the status of the test as Pass, Fail, or Error.
Remarks/Comments	The Remarks/Comments column displays the relevant details, for example, Tbit, Vswing, and Margin. If the test could not be run, then an error code appears.
Close	Click Close to quit the Result Details dialog box.

0

Differential Tests Select All

This option enables you to run the eye diagram, duty cycle, rise time, fall time, and clock jitter test simultaneously.

You will need one supported oscilloscope, two/four differential probes, one DC power supply 3.3 V, one EDID emulator, and one TPA-P fixture.

NOTE. For the DPO/DSA70000 series oscilloscopes with P7313 SMA probes and Efficere fixtures, you have the option to set the probe control voltage to **internal** from the [Preferences](#) menu. If this option is selected, an external power supply is not required.

1. On the menu bar, click **Tests > Select > Source**.
2. In the differential tests pane, click **Select All**.

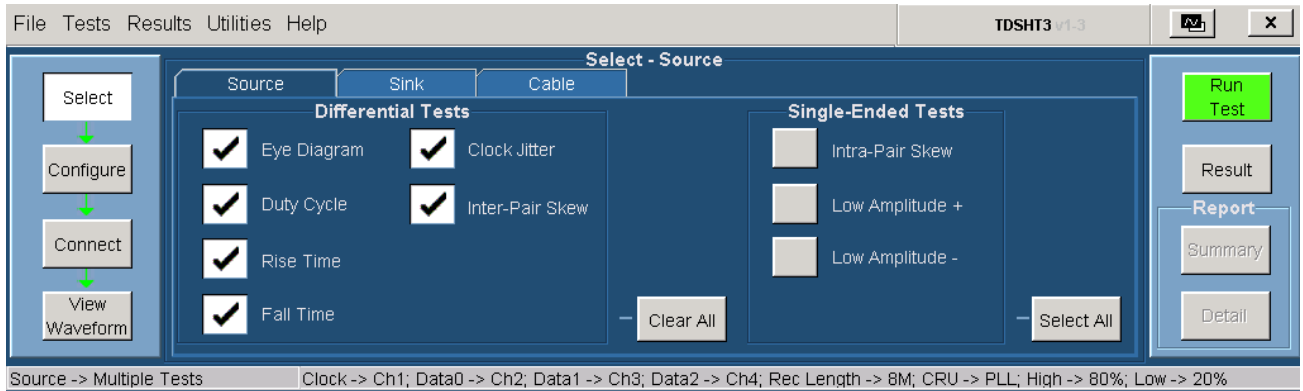

3. To change the configuration settings, click **Tests > Configure**. For most tests, you can use the factory default configuration. However, you can change the values by using the [virtual keyboard](#) or the [general purpose knob](#) on the oscilloscope front panel. Using the File menu, you can also restore the factory defaults or save and recall your own configuration settings. It is recommended that you save the configuration settings before you choose to select Recall Default or close the application.

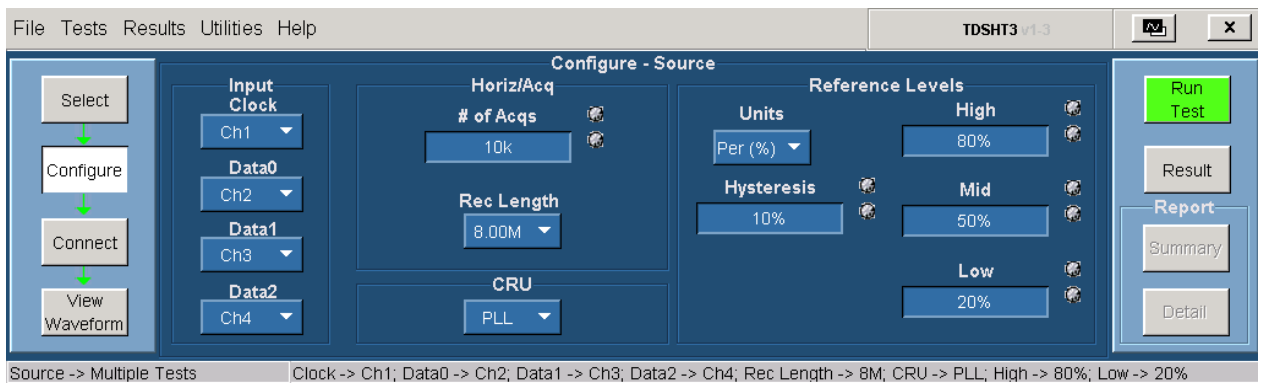

For 2-Channel setup, the configuration is as follows:

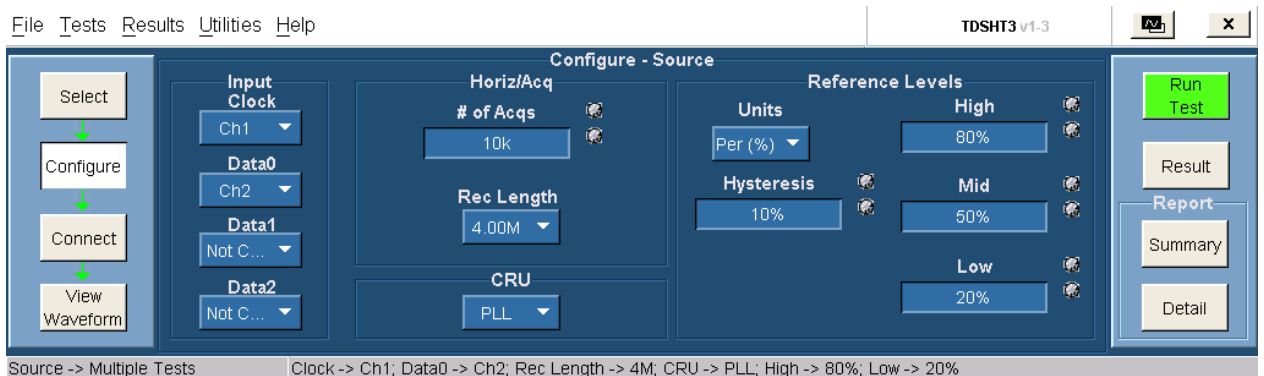

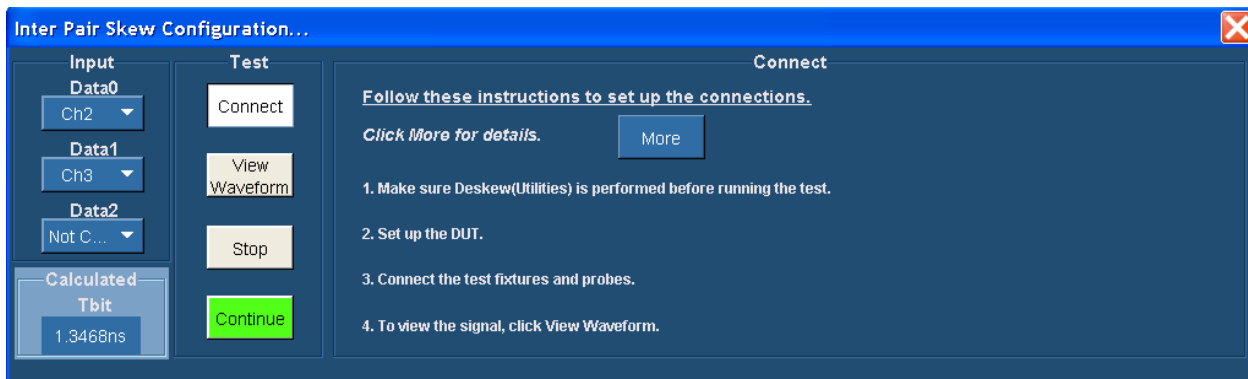

Remove the clock signal connection and connect the data pair between which you want to calculate the skew.

4. In the input pane, you have the following options:

Configure parameter	Description
Clock	Clock indicates the source channel to which you will connect the HDMI clock input lane. The available choices are Ch1, Ch2, Ch3, and Ch4.
Data0	Data0 indicates the source channel to which you will connect the HDMI data0 input lane. The available choices are Ch1, Ch2, Ch3, Ch4, and Not Conn.
Data1	Data1 indicates the source channel to which you will connect the HDMI data1 input lane. The available choices are Ch1, Ch2, Ch3, Ch4, and Not Conn.
Data2	Data2 indicates the source channel to which you will connect the HDMI data2 input lane. The available choices are Ch1, Ch2, Ch3, Ch4, and Not Conn.

5. In the horiz/acq pane, you have the following options:

Configure parameter	Description
# of Acqs	The # of Acqs box displays the number of acquisitions that are required for the test. The default value is 10k.
Record Length	In the Rec Length box, enter the desired record length value for all the selected tests.

6. In the CRU pane, you have the following option:

Configure parameter	Description
CRU	The CRU list allows you to configure the Clock Recovery Unit. The available choices are PLL, Raw, and Ideal. The default value is first order PLL and is used for compliance testing. Raw and Ideal are used for analysis.
Define	The Define is available only when PLL is selected.

7. In the reference levels pane, you have the following options:

Configure parameter	Description
Units	The Units list allows you to set the reference level units to either Per (%) or Abs. Per (%) indicates that the reference levels are a percentage of the Vswing value. Abs indicates that the reference levels are absolute voltage values.
Hysteresis	In the Hysteresis box, enter the desired hysteresis percent value. The default value is 10 percent. The hysteresis range is between 2 percent and 10 percent.
High	The High box displays the high reference voltage value. The default value is 80 percent.
Mid	In the Mid box, enter the desired mid reference voltage value. The default value is 50 percent.
Low	The Low box displays the low reference voltage value. The default value is 20 percent.

8. To connect the DUT, click **Tests > Connect**. [Click here](#) for information on how to make connections.

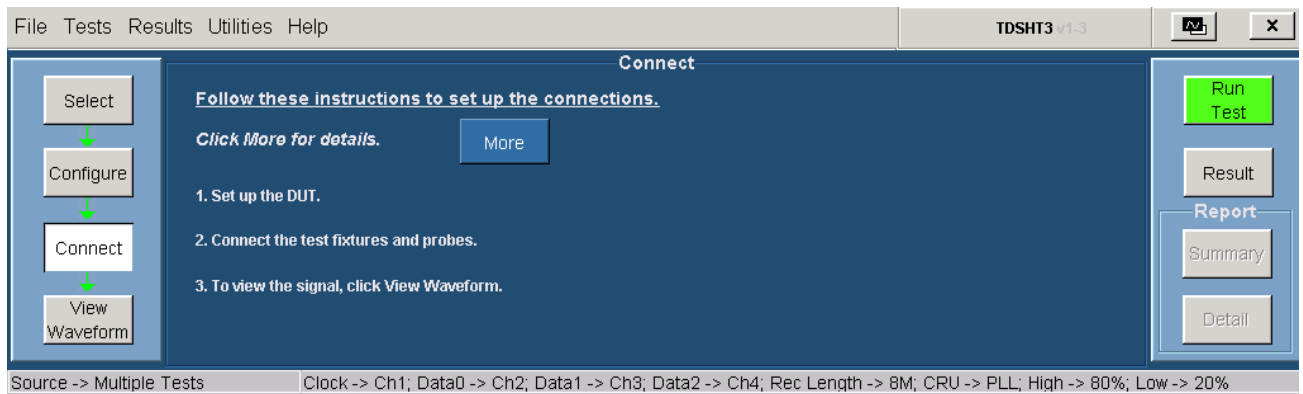

9. Ensure that your signal in the oscilloscope display is similar to the sample signal. Click **View Waveform** to display a sample of the expected signal. If the displays are not similar, go back and check your configuration and connections.

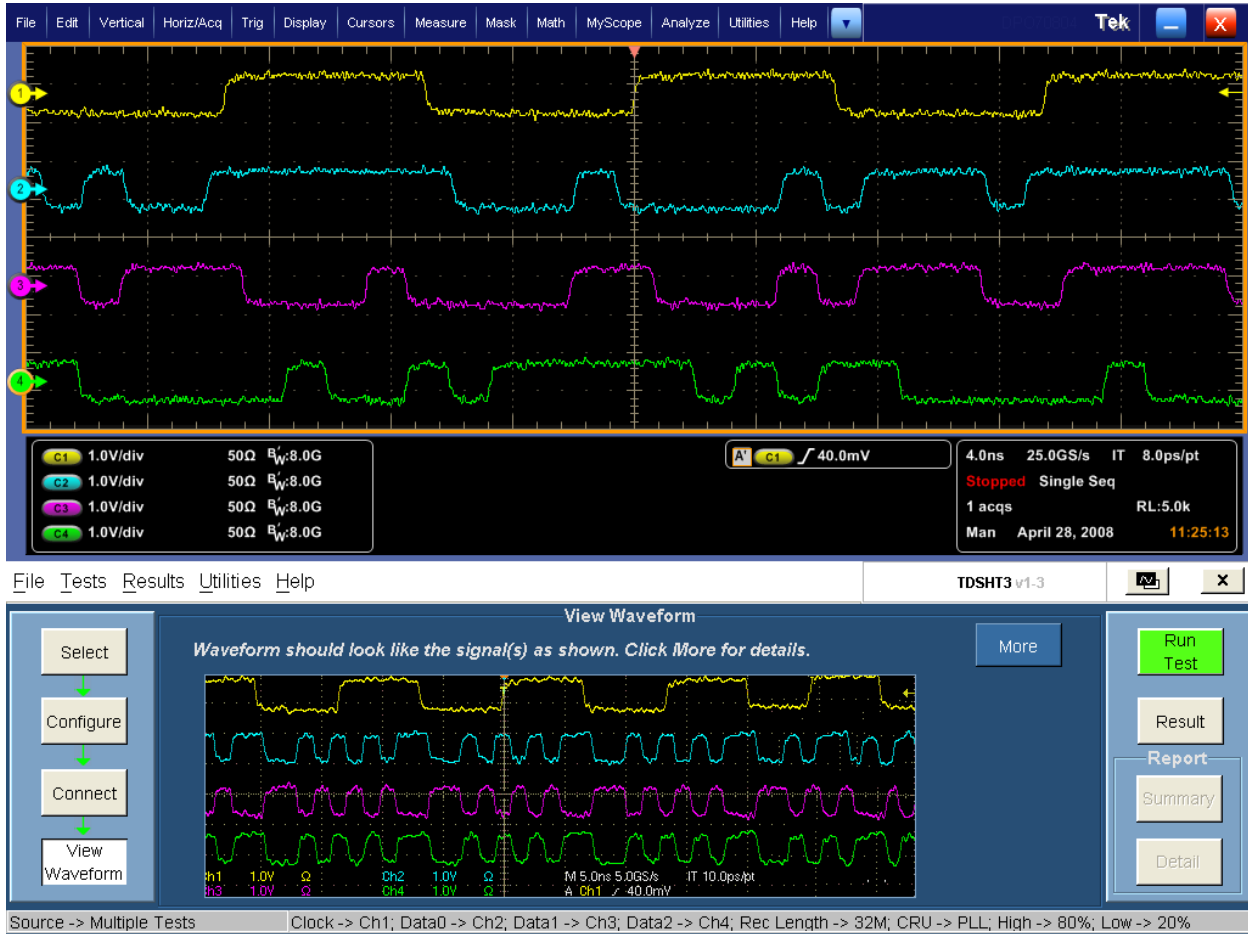

10. Click **Run Test** to perform the test. The TDSHT3 HDMI Compliance Test Software sets up the oscilloscope and the test runs, displaying a progress indicator.

11. If you have run the tests successfully, the software makes Result available automatically and displays the eye diagram plot and the clock jitter plot. For more information on the plots, refer to the section on the eye diagram and the clock jitter tests. You can also view both the result summary of the test and the report configuration in the result pane as shown in the following figure:

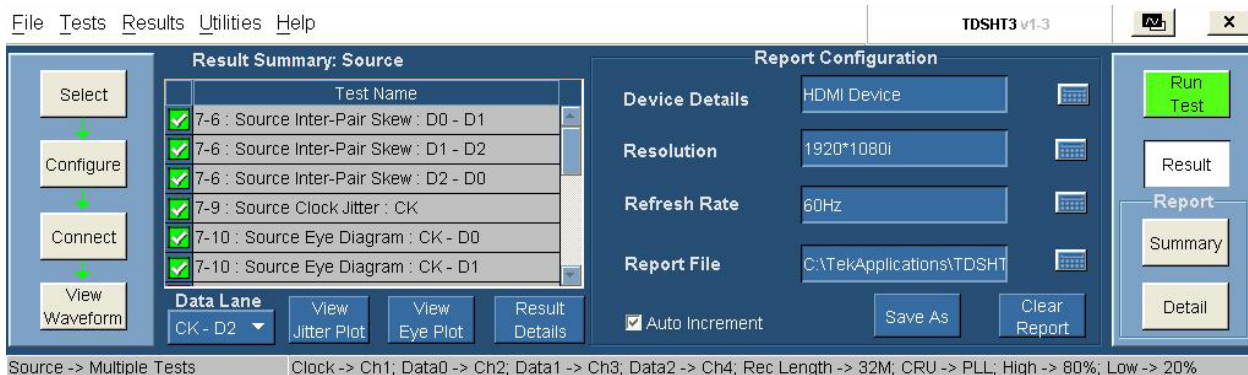

Option	Description
Test Name	The Test Name box displays the test id, test name, and selected lanes.
Status	Status indicates the status of the test as Pass, Fail, or Error.
View Jitter Plot	Click View Jitter Plot to view the jitter plot for the clock jitter test.
View Eye Plot	Click View Eye Plot to view the eye plot for the eye diagram test.
Result Details	Click Result Details to display the details of the result.

12. You can set the report details to identify and generate the report automatically. You can set a default report file.

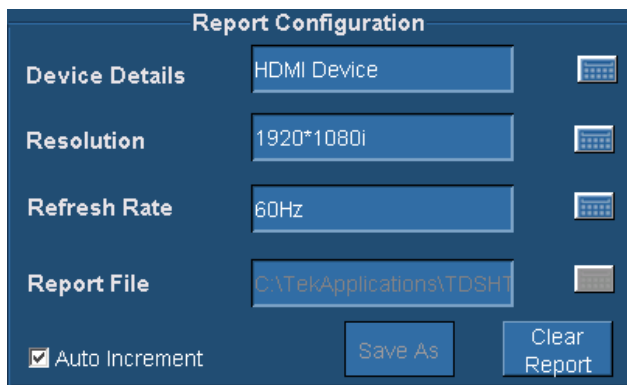

In the report configuration pane, you can configure the following parameters:

Category	Description
Device Details	The Device Details box allows you to specify the device-related information on which the test is conducted.
Resolution	The Resolution box allows you to specify the resolution on which the test is conducted.
Refresh Rate	The Refresh Rate box allows you to specify the refresh rate at which the test is conducted.
Report File	The Report File box allows you to specify the path and the file where the generated report will be saved. However, a default file name and path already exists.
Auto Increment	Select the Auto Increment check box to generate a new report. Selecting this option does not overwrite the existing report. However, it adds the date and time to the existing file name.

Category	Description
Save As	Click Save As to save the generated reports. The Save File dialog box is displayed. You can enter a file name and save the report.
Clear Report	Click Clear Report to clear all the results and records of the earlier tests.

13. In the result summary pane, click **Result Details** to display the details of the result.

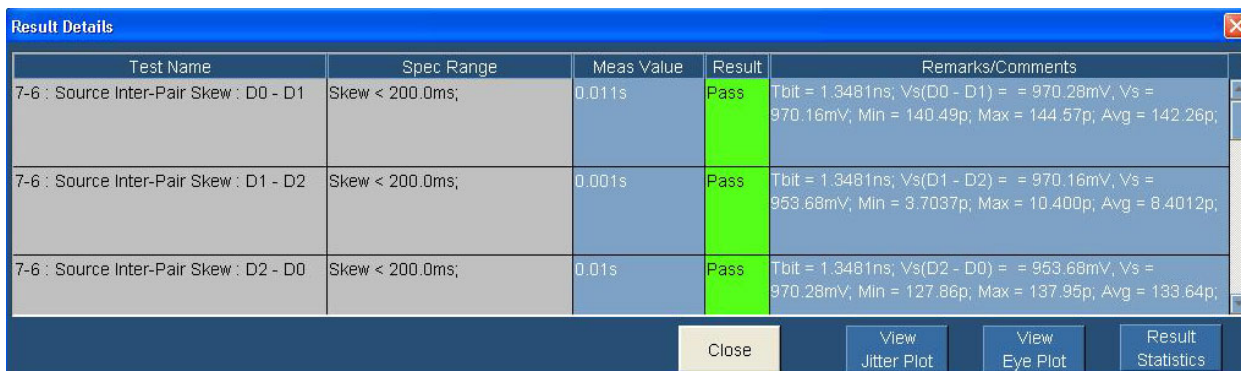

Options	Description
Test Name	The Test Name column displays the test id, test name, and selected lanes.
Spec Range	The Spec Range column describes the HDMI standards and test specifications limit for the test.
Meas Value	The Meas Value column displays the measured value.
Result	The Result column displays the status of the test as Pass, Fail, or Error.
Remarks/Comments	The Remarks/Comments column displays the results of Tbit, Vswing, and Margin. If the test could not be run, then an error code appears.
Close	Click Close to quit the Result Details dialog box.
View Jitter Plot	Click View Jitter Plot to display the jitter plot for the clock jitter test.
View Eye Plot	Click View Eye Plot to display the eye plot for the eye diagram test.
Result Statistics	Click Result Statistics to display statistics based on the tests.

14. In the Result Details dialog box, click **Result Statistics** to display statistics based on the tests.

Test Name	Population	Min	Max	Mean	Std Dev	Pk-Pk
Source Clock Jitter : Tx Clock TIE	144.72k	-89.966us	0.00s	0.00s	51.859us	89.966us
Source Clock Jitter : Recovered Clock ...	144.72k	-89.956us	0.00s	-45.027us	25.727us	89.956us
Source Eye Diagram : Tx Clock TIE	144.72k	-89.966us	0.00s	0.00s	51.859us	89.966us
Source Eye Diagram : Recovered Cloc...	144.72k	-89.956us	0.00s	-45.027us	25.727us	89.956us
7-4 : Source Rise Time : CK	119.31k	150.44ps	151.85ps	150.74ps	310.88fs	1.4034ps
7-4 : Source Rise Time : D0	92.596k	150.39ps	151.75ps	150.77ps	316.33fs	1.3527ps
7-4 : Source Rise Time : D1	114.89k	136.76ps	139.04ps	138.32ps	553.61fs	2.2836ps
7-4 : Source Rise Time : D2	119.25k	151.10ps	152.17ps	151.55ps	240.21fs	1.0755ps

The software calculates statistics for each selected test, and logs the statistics on a cycle-by-cycle basis in a large waveform. The standard statistics are for the Maximum, Minimum, Mean, Standard Deviation, and Population.

Options	Description
Test Name	The Test Name column displays the test id, test name, and selected lanes.
Population	The software calculates this statistic by using the following equation: Population (X) = N
Min	The software calculates this statistic by using the following equation: Min (X) = Lowest value of X
Max	The software calculates this statistic by using the following equation: Max (X) = Highest value of X
Mean	The software calculates this statistic by using the following equation: $Mean (X) = \bar{X} = \frac{1}{N} \sum_{n=1}^N X_n$
Std Dev	The software calculates this statistic by using the following equation: $Standard Deviation (X) = \sigma_x = \sqrt{\frac{1}{(N-1)} \sum_{n=1}^N (X_n - \bar{X})^2}$
Pk-Pk	The software calculates this statistic by using the following equation: Xppn = Max(X) – Min(X)
Close	Click Close to quit the Result Statistics dialog box.

NOTE. Perform similar steps as mentioned in this procedure to test Single-Ended Select All.

Intra-Pair Skew (Source)

This test allows you to confirm that any skew within any one differential pair in the TMDS portion of the HDMI link does not exceed the limits in the specification.

You will need one supported oscilloscope, two single-ended probes, one DC power supply 3.3 V, one EDID emulator, and one TPA-P fixture.

NOTE. For the DPO/DSA70000 series oscilloscopes with P7313 SMA probes and Efficere fixtures, you have the option to set the probe control voltage to **internal** from the [Preferences](#) menu. If this option is selected, an external power supply is not required.

[Deskew](#) is recommended before you conduct any skew test.

1. On the menu bar, click **Tests > Select > Source**.
2. In the single-ended tests pane, select the Intra-Pair Skew check box.

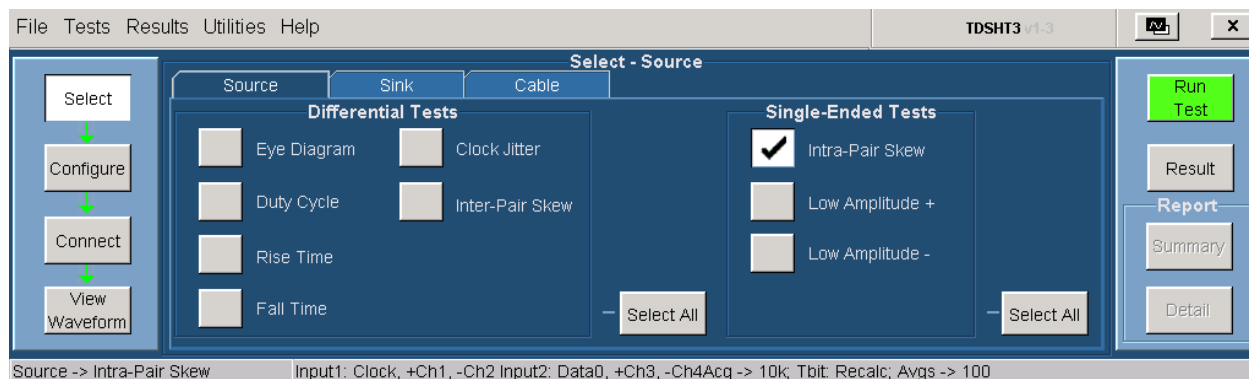

3. To change the configuration settings, click **Tests > Configure**. For most tests, you can use the factory default configuration. However, you can change the values by using the [virtual keyboard](#) or the [general purpose knob](#) on the oscilloscope front panel. Using the File menu, you can also restore the factory defaults or save and recall your own configuration settings. It is recommended that you save the configuration settings before you choose to select Recall Default or close the application.

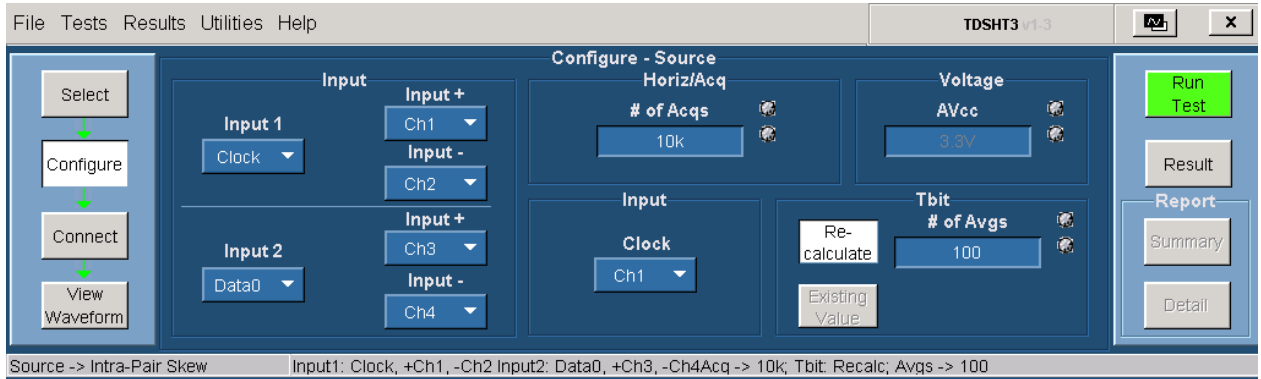

4. In the input pane, you have the following options:

Configure parameter	Description
Input1	Input1 indicates the source channel to which you will connect the HDMI input. The available choices are Clock, Data0, Data1, and Data2.
Input+	Input+ indicates the source channel to which you will connect the positive input. The available choices are Ch1, Ch2, Ch3, and Ch4.
Input-	Input- indicates the source channel to which you will connect the negative input. The available choices are Ch1, Ch2, Ch3, and Ch4.
Input2	Input2 indicates the source channel to which you will connect the HDMI input. The available choices are Clock, Data0, Data1, Data2, and Not Conn.
Input+	Input+ indicates the source channel to which you will connect the positive input. The available choices are Ch1, Ch2, Ch3, and Ch4.
Input-	Input- indicates the source channel to which you will connect the negative input. The available choices are Ch1, Ch2, Ch3, and Ch4.

5. In the horiz/acq pane, you have the following option:

Configure parameter	Description
# of Acqs	In the # of Acqs box, enter the desired number of acquisitions that are required for the test. The default value is 10 K.

6. In the tbit pane, you have the following options:

Configure parameter	Description
# of Avgs	In the # of Avgs box, enter the desired number of periods that are considered to calculate Tbit. The default value is 100.
Re-calculate	Click Re-calculate to recalculate the Tbit value.
Existing Value	Click Existing Value to use the previously calculated Tbit value.

7. To connect the DUT, click **Tests > Connect**. [Click here](#) for information on how to make connections.

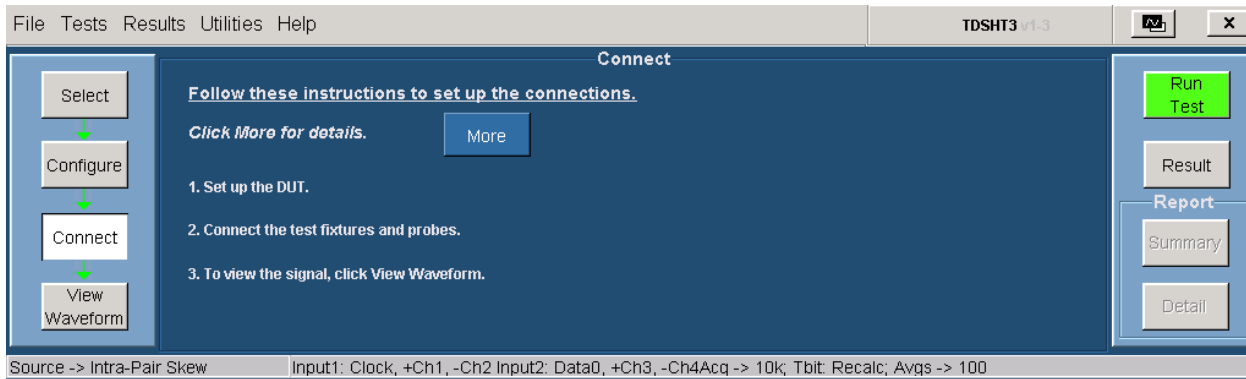

8. Ensure that your signal in the oscilloscope display is similar to the sample signal. Click **View Waveform** to display a sample of the expected signal. If the displays are not similar, go back and check your configuration and connections. The waveform shown here is for the re-calculate Tbit option. Click **Run Test** to run the test. The Confirm dialog box appears. Click **Continue** to continue to run the test. Go to step 10.

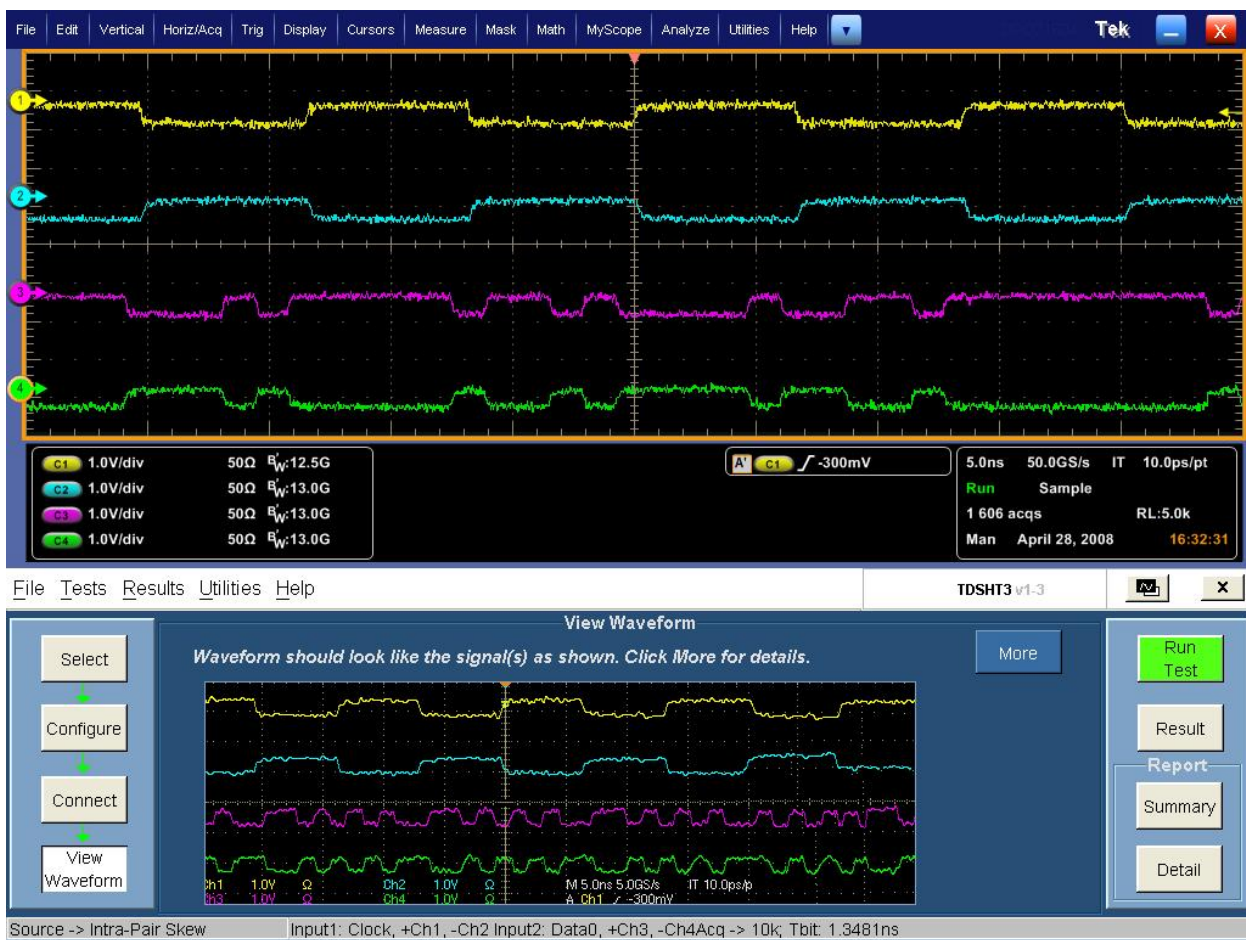

9. If you have selected existing Tbit value, then click **View Waveform** to get a different waveform on your display. Ensure that your signal in the oscilloscope display is similar to the sample signal.
10. Click **Run Test** to run the test. The TDSHT3 HDMI Compliance Test Software sets up the oscilloscope and the test runs, displaying a progress indicator.
11. The software makes Result available automatically and displays the result summary. You can also view the report configuration details in the result pane.

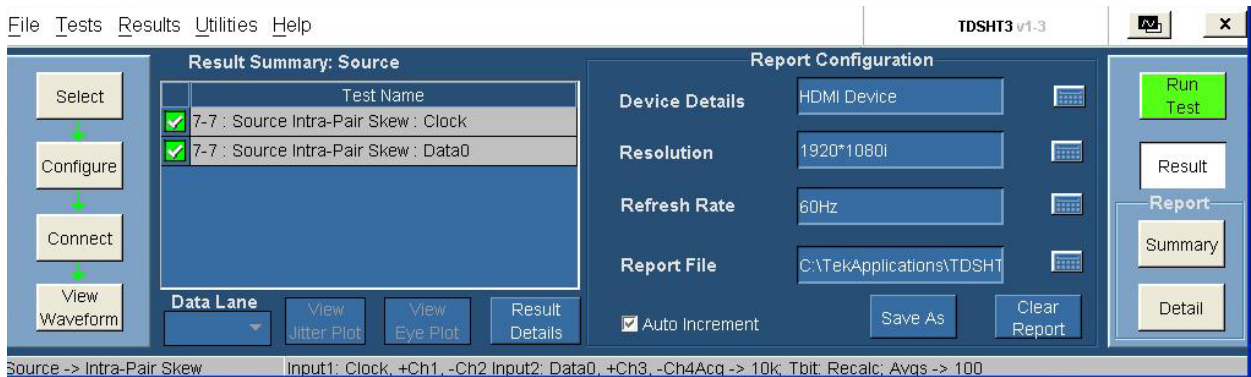

Options	Description
Test Name	The Test Name box displays the test id, test name, and selected lanes.
Status	Status indicates the status of the test as Pass, Fail, or Error.
Result Details	Click Result Details to display the details of the result.

12. You can set the report details to identify and generate the report automatically. You can set a default report file.

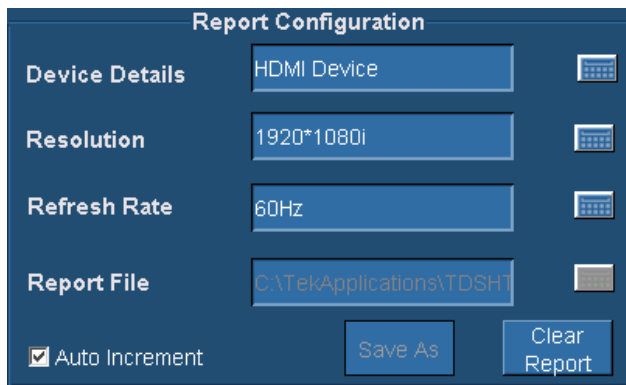

In the report configuration pane, you can configure the following parameters:

Category	Description
Device Details	The Device Details box allows you to specify the device-related information on which the test is conducted.
Resolution	The Resolution box allows you to specify the resolution on which the test is conducted.
Refresh Rate	The Refresh Rate box allows you to specify the refresh rate at which the test is conducted.
Report File	The Report File box allows you to specify the path and the file where the generated report will be saved. However, a default file name and path already exists.
Auto Increment	Select the Auto Increment check box to generate a new report. Selecting this option does not overwrite the existing report. However, it adds the date and time to the existing file name.
Save As	Click Save As to save the generated reports. The Save File dialog box is displayed. You can enter a file name and save the report.
Clear Report	Click Clear Report to clear all the results and records of the earlier tests.

13. In the result summary pane, click **Result Details** to display the details of the result.



Options	Description
Test Name	The Test Name column displays the test id, test name, and selected lanes.
Spec Range	The Spec Range column displays the HDMI standards and test specifications limit for the test.
Meas Value	The Meas Value column displays the measured value.
Result	The Result column displays the status of the test as Pass, Fail, or Error.
Remarks/Comments	The Remarks/Comments column displays the relevant details, for example, Tbit, Vswing, and Margin. If the test could not be run, then an error code appears.
Close	Click Close to quit the Result Details dialog box.

Low Amplitude +

This test allows you to confirm that DC voltage levels on the HDMI link are within specified limits for each TMDS signal.

You will need one supported oscilloscope, one single-ended probe, one DC power supply 3.3 V, one EDID emulator, and one TPA-P fixture.

NOTE. For the DPO/DSA70000 series oscilloscopes with P7313 SMA probes and Efficere fixtures, you have the option to set the probe control voltage to **internal** from the [Preferences](#) menu. If this option is selected, an external power supply is not required.

1. On the menu bar, click **Tests > Select > Source**.
2. In the single-ended tests pane, select the Low Amplitude + check box.

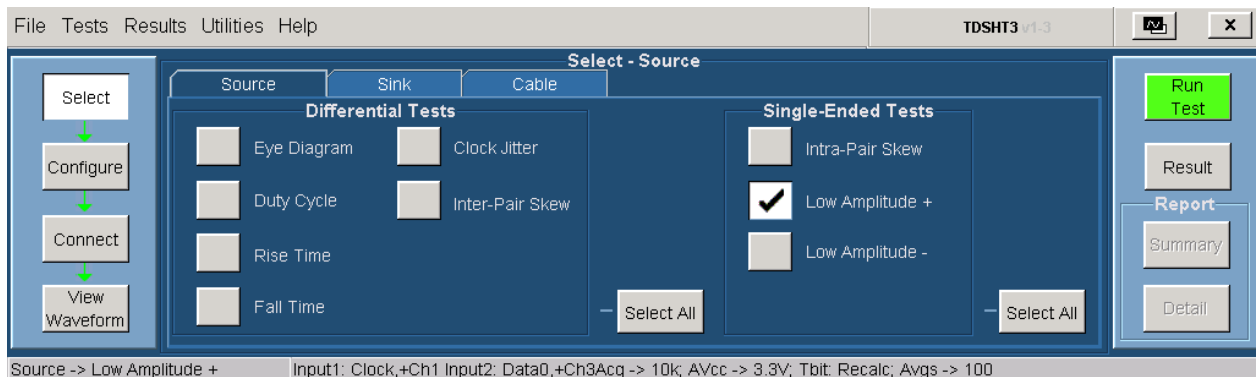

3. To change the configuration settings, click **Tests > Configure**. For most tests, you can use the factory default configuration. However, you can change the values by using the [virtual keyboard](#) or the [general purpose knob](#) on the oscilloscope front panel. Using the File menu, you can also restore the factory defaults or save and recall your own configuration settings. It is recommended that you save the configuration settings before you choose to select Recall Default or close the application.

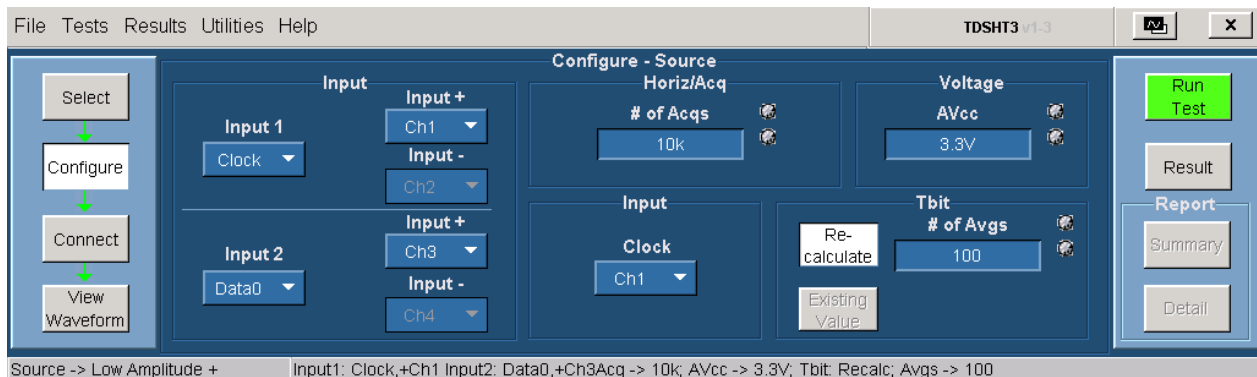

4. In the input pane, you have the following options:

Configure parameter	Description
Input1	Input1 indicates the source channel to which you will connect the HDMI input. The available choices are Ch1, Ch2, Ch3, and Ch4.
Input+	Input+ indicates the source channel to which you will connect the positive input. The available choices are Ch1, Ch2, Ch3, and Ch4.
Input2	Input2 indicates the source channel to which you will connect the HDMI input. The available choices are Ch1, Ch2, Ch3, Ch4, and Not Conn.
Input+	Input+ indicates the source channel to which you will connect the positive input. The available choices are Ch1, Ch2, Ch3, and Ch4.

5. In the horiz/acq pane, you have the following option:

Configure parameter	Description
# of Acqs	In the # of Acqs box, enter the desired number of acquisitions that are required for the test. The default value is 10 K.

6. In the tbit pane, you have the following options:

Configure parameter	Description
# of Avgs	In the # of Avgs box, enter the desired number of periods that are considered to calculate Tbit. The default value is 100.
Re-calculate	Click Re-calculate to recalculate the Tbit value.
Existing Value	Click Existing Value to use the previously calculated Tbit value.

7. In the voltage pane, you have the following option:

Configure parameter	Description
AVcc	In the AVcc box, enter the desired voltage value. The default value is 3.3 V.

8. To connect the DUT, click **Tests > Connect**. [Click here](#) for information on how to make connections.

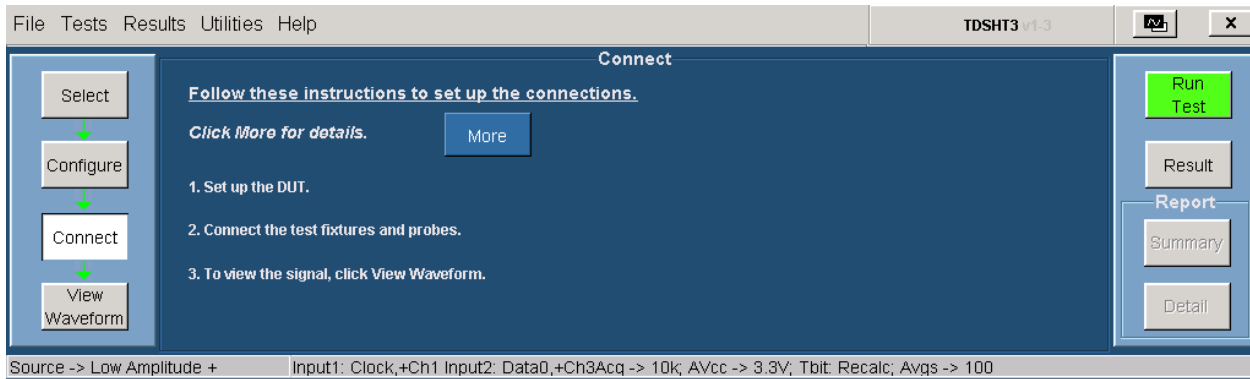

- 9. Ensure that your signal in the oscilloscope display is similar to the sample signal. Click **View Waveform** to display a sample of the expected signal. If the displays are not similar, go back and check your configuration and connections. The waveform shown here is for the re-calculate Tbit option. Click **Run Test** to run the test. The Confirm dialog box appears. Click **Continue** to continue to run the test. Go to step 11.



10. If you have selected existing Tbit value, then click **View Waveform** to get a different waveform on your display. Ensure that your signal in the oscilloscope display is similar to the sample signal.
11. Click **Run Test** to run the test. The TDSHT3 HDMI Compliance Test Software sets up the oscilloscope and the test runs, displaying a progress indicator.
12. The software makes Result available automatically and displays the result summary. You can also view the report configuration details in the result pane.

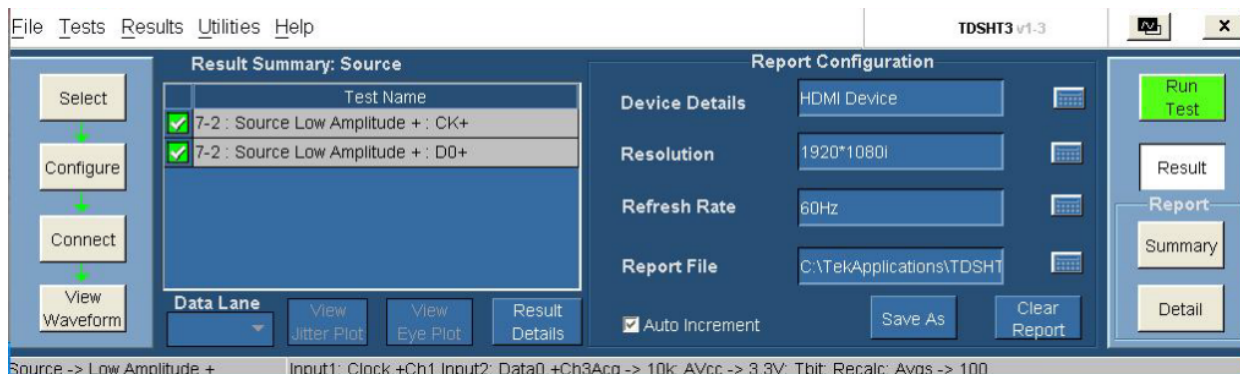

Option	Description
Test Name	The Test Name box displays the test id, test name, and selected lanes.
Status	Status indicates the status of the test as Pass, Fail, or Error.
Result Details	Click Result Details to display the details of the result.

13. You can set the report details to identify and generate the report automatically. You can set a default report file.

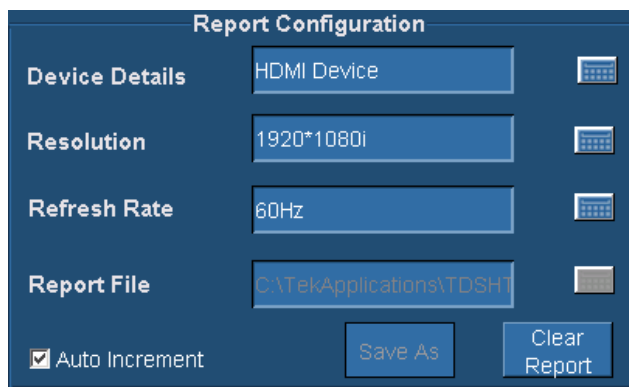

In the report configuration pane, you can configure the following parameters:

Category	Description
Device Details	The Device Details box allows you to specify the device-related information on which the test is conducted.
Resolution	The Resolution box allows you to specify the resolution on which the test is conducted.
Refresh Rate	The Refresh Rate box allows you to specify the refresh rate at which the test is conducted.
Report File	The Report File box allows you to specify the path and the file where the generated report will be saved. However, a default file name and path already exists.
Auto Increment	Select the Auto Increment check box to generate a new report. Selecting this option does not overwrite the existing report. However, it adds the date and time to the existing file name.
Save As	Click Save As to save the generated reports. The Save File dialog box is displayed. You can enter a file name and save the report.
Clear Report	Click Clear Report to clear all the results and records of the earlier tests.

14. In the result summary pane, click **Result Details** to display the details of the result.



Options	Description
Test Name	The Test Name column displays the test id, test name, and selected lanes.
Spec Range	The Spec Range column displays the HDMI standards and test specifications limit for the test.
Meas Value	The Meas Value column displays the measured value in volts.
Result	The Result column displays the status of the test as Pass, Fail, or Error.

Options	Description
Remarks/Comments	The Remarks/Comments column displays the relevant details of Tbit, Vswing, Upper Margin, and Lower Margin. If the test could not be run, then an error code appears.
Close	Click Close to quit the Result Details dialog box.

Low Amplitude -

This test allows you to confirm that DC voltage levels on the HDMI link are within specified limits for each TMDS signal.

You will need one supported oscilloscope, one single-ended probe, one DC power supply 3.3 V, one EDID emulator, and one TPA-P fixture.

NOTE. For the DPO/DSA70000 series oscilloscopes with P7313 SMA probes and Efficere fixtures, you have the option to set the probe control voltage to **internal** from the [Preferences](#) menu. If this option is selected, an external power supply is not required.

1. On the menu bar, click **Tests > Select > Source**.
2. In the single-ended tests pane, select the Low Amplitude - check box.

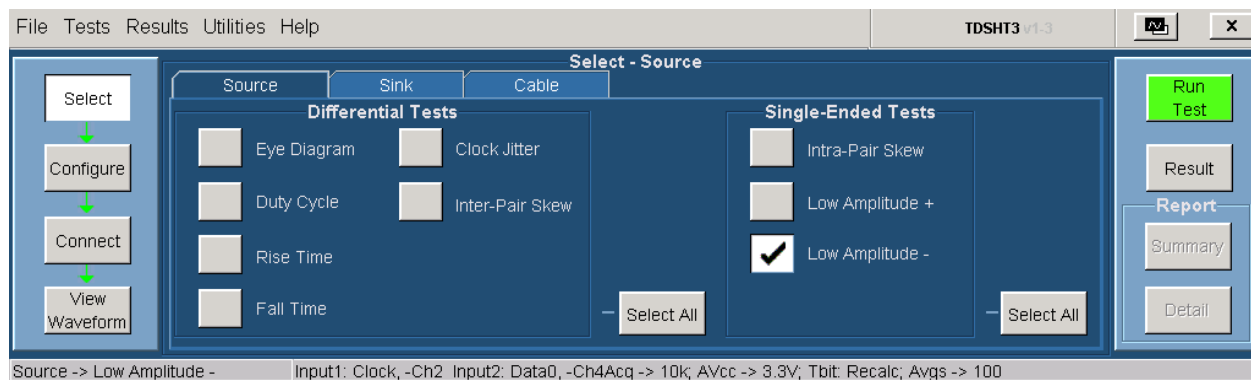

3. To change the configuration settings, click **Tests > Configure**. For most tests, you can use the factory default configuration. However, you can change the values by using the [virtual keyboard](#) or the [general purpose knob](#) on the oscilloscope front panel. Using the File menu, you can also restore the factory defaults or save and recall your own configuration settings. It is recommended that you save the configuration settings before you choose to select Recall Default or close the application.

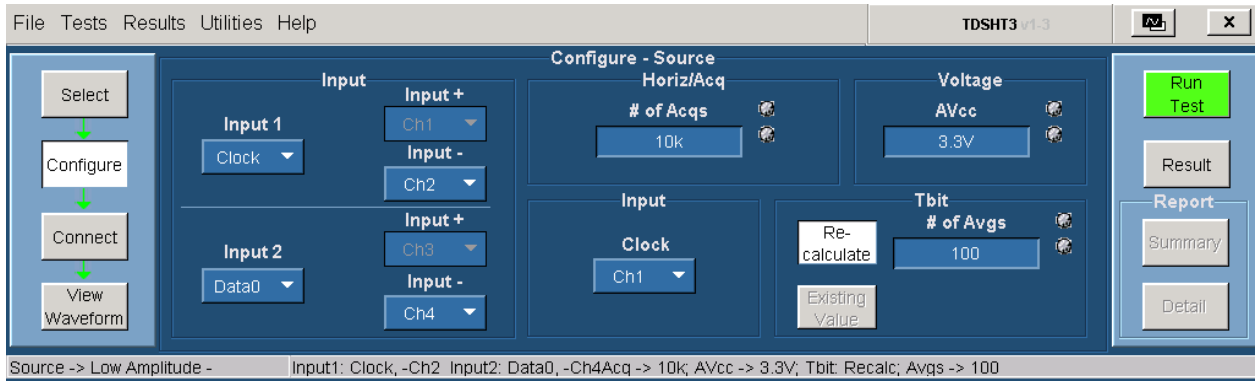

4. In the input pane, you have the following options:

Configure parameter	Description
Input1	Input1 indicates the source channel to which you will connect the HDMI input. The available choices are Ch1, Ch2, Ch3, and Ch4.
Input-	Input- indicates the source channel to which you will connect the negative input. The available choices are Ch1, Ch2, Ch3, and Ch4.
Input2	Input2 indicates the source channel to which you will connect the HDMI input. The available choices are Ch1, Ch2, Ch3, Ch4, and Not Conn.
Input-	Input- indicates the source channel to which you will connect the input. The available choices are Ch1, Ch2, Ch3, Ch4, and Not Conn.

5. In the horiz/acq pane, you have the following option:

Configure parameter	Description
# of Acqs	In the # of Acqs box, enter the desired number of acquisitions that are required for the test. The default value is 10 K.

6. In the tbit pane, you have the following options:

Configure parameter	Description
# of Avgs	In the # of Avgs box, enter the desired number of periods that are considered to calculate Tbit. The default value is 100.
Re-calculate	Click Re-calculate to recalculate the Tbit value.
Existing Value	Click Existing Value to use the previously calculated Tbit value.

7. In the voltage pane, you have the following option:

Configure parameter	Description
AVcc	In the AVcc box, enter the desired voltage value. The default value is 3.3 V.

8. To connect the DUT, click **Tests > Connect**. [Click here](#) for information on how to make connections.

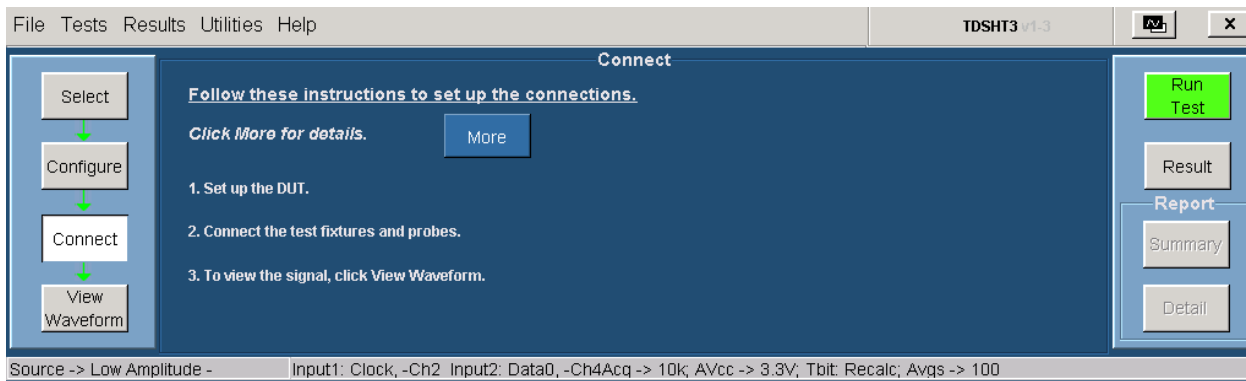

9. Ensure that your signal in the oscilloscope display is similar to the sample signal. Click **View Waveform** to display a sample of the expected signal. If the displays are not similar, go back and check your configuration and connections. The waveform shown here is for the re-calculate Tbit option. Click **Run Test** to run the test. The Confirm dialog box appears. Click **Continue** to continue to run the test. Go to step 11.

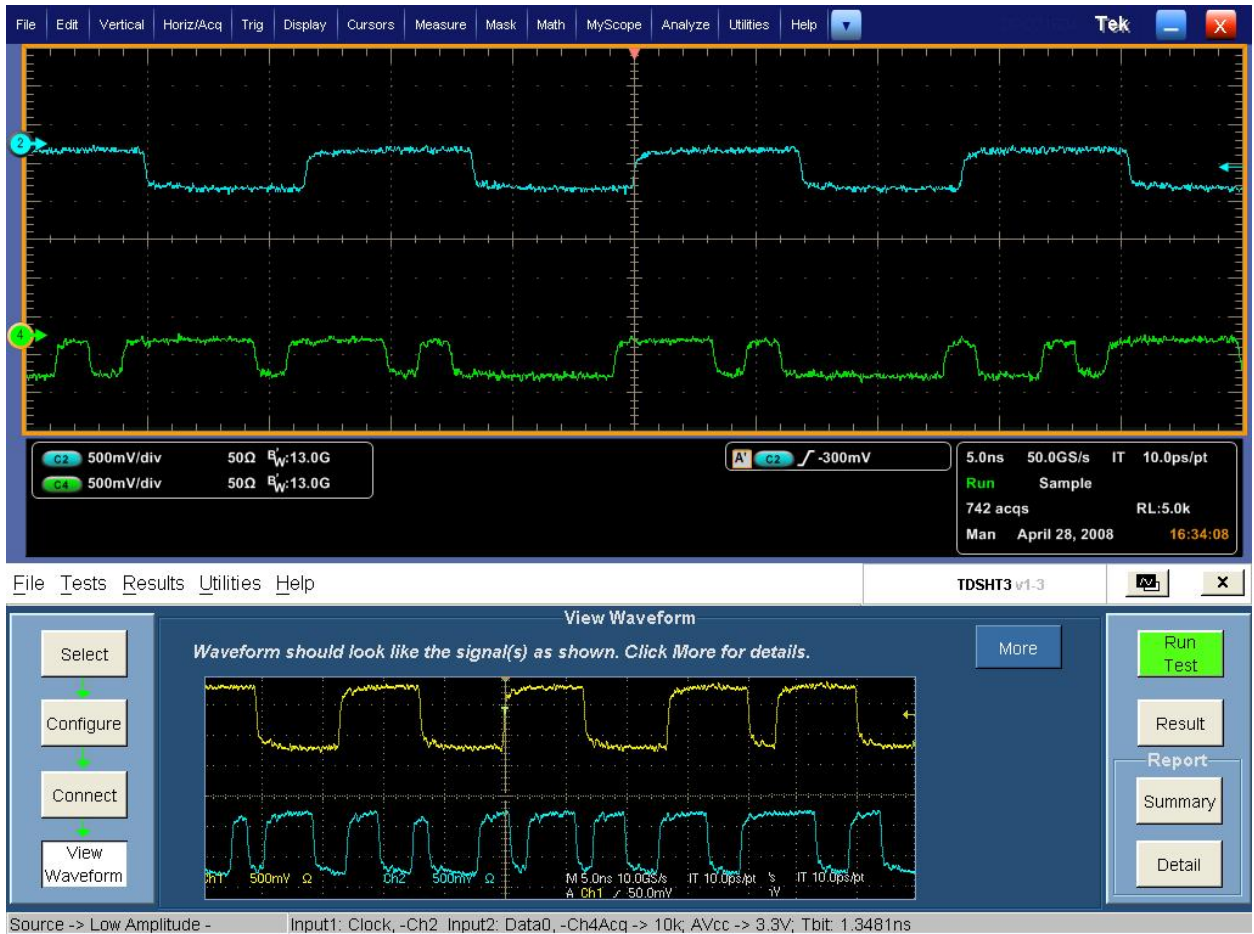

10.If you have selected existing Tbit value, then click **View Waveform** to get a different waveform on your display. Ensure that your signal in the oscilloscope display is similar to the sample signal.

11.Click **Run Test** to run the test. The TDSHT3 HDMI Compliance Test Software sets up the oscilloscope and the test runs, displaying a progress indicator.

12.The software makes Result available automatically and displays the result summary. You can also view the report configuration details in the result pane.

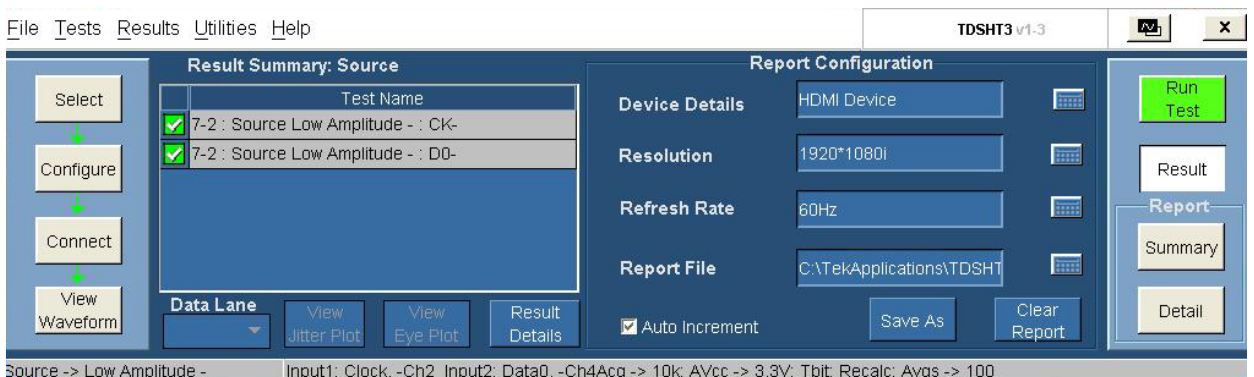

Option	Description
Test Name	The Test Name box displays the test id, test name, and selected lanes.
Status	Status indicates the status of the test as Pass, Fail, or Error.
Result Details	Click Result Details to display the details of the result.

13. You can set the report details to identify and generate the report automatically. You can set a default report file.

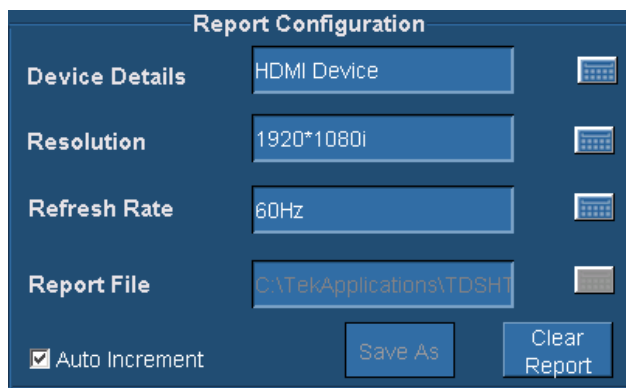

In the report configuration pane, you can configure the following parameters:

Category	Description
Device Details	The Device Details box allows you to specify the device-related information on which the test is conducted.
Resolution	The Resolution box allows you to specify the resolution on which the test is conducted.
Refresh Rate	The Refresh Rate box allows you to specify the refresh rate at which the test is conducted.
Report File	The Report File box allows you to specify the path and the file where the generated report will be saved. However, a default file name and path already exists.
Auto Increment	Select the Auto Increment check box to generate a new report. Selecting this option does not overwrite the existing report. However, it adds the date and time to the existing file name.
Save As	Click Save As to save the generated reports. The Save File dialog box is displayed. You can enter a file name and save the report.
Clear Report	Click Clear Report to clear all the results and records of the earlier tests.

14. In the result summary pane, click **Result Details** to display the details of the result.

Test Name	Spec Range	Meas Value	Result	Remarks/Comments
7-2 : Source Low Amplitude - : CK-	2.700V < VL < 2.900V;	2.7525V	Pass	Upper Margin = 147.5mV; Lower Margin = 52.50mV;
7-2 : Source Low Amplitude - : D0-	2.700V < VL < 2.900V;	2.7450V	Pass	Upper Margin = 155.0mV; Lower Margin = 45.00mV;

Buttons: Close, View Jitter Plot, View Eye Plot, Result Statistics

Options	Description
Test Name	The Test Name column displays the test id, test name, and selected lanes.
Spec Range	The Spec Range column displays the HDMI standards and test specifications limit for the test.
Meas Value	The Meas Value column displays the measured value in volts.
Result	The Result column displays the status of the test as Pass, Fail, or Error.
Remarks/Comments	The Remarks/Comments column displays the relevant details of Tbit, Vswing, Upper Margin, and Lower Margin. If the test could not be run, then an error code appears.
Close	Click Close to quit the Result Details dialog box.

Min/Max-Diff Swing Tolerance

This test allows you to confirm that the Sink correctly supports TMDS differential voltages at minimum levels.

You will need one supported oscilloscope, one digital timing generator (DTG), one differential probe, one DC power supply, eight SMA cables, one GPIB controller, and one TPA-P-TDR fixture.

1. On the menu bar, click **Tests > Select > Sink**.
2. In the differential tests pane, select the Min/Max-Diff Swing Tolerance check box.

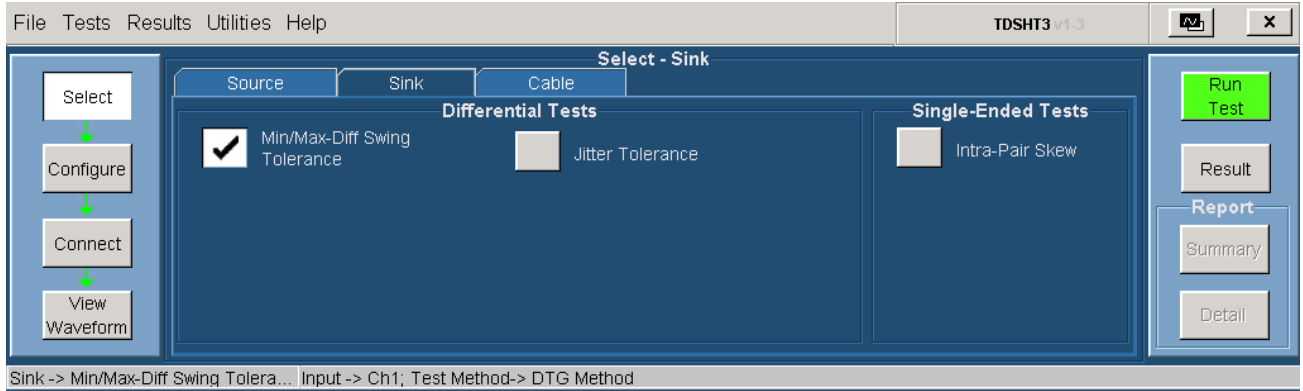

3. To change the configuration settings, click **Tests > Configure**. For most tests, you can use the factory default configuration. However, you can change the values by using the [virtual keyboard](#) or the [general purpose knob](#) on the oscilloscope front panel. Using the File menu, you can also restore the factory defaults or save and recall your own configuration settings. It is recommended that you save the configuration settings before you choose to select Recall Default or close the application.

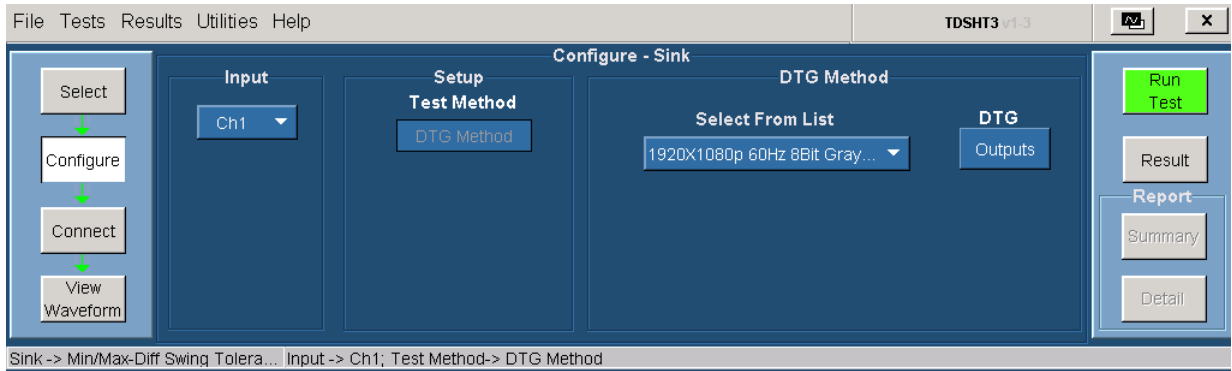

4. In the Input pane, you have the following option:

Configure parameter	Description
Input	Input indicates the channel to which you will connect the HDMI input signal. The available choices are Ch1, Ch2, Ch3, and Ch4.

5. In the DTG Method pane, you have the following option:

Configure parameter	Description
Select From List	Select the DTG pattern file from the drop-down list.
Outputs	Click outputs to display a dialog box where you can set unique Clock, Data0, Data1, and Data2 outputs.

6. The DTG Outputs dialog box has the following options:

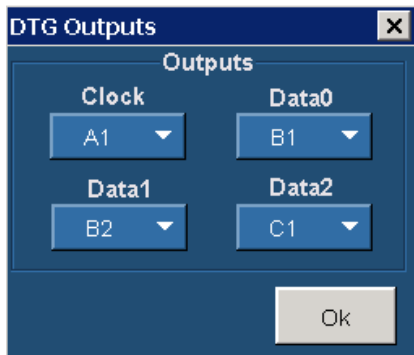

Configure parameter	Description
Clock	The Clock list allows you to configure the output. The available choices are A1, A2, B1, B2, C1, C2, D1, and D2.
Data0	The Data0 list allows you to configure the output. The available choices are A1, A2, B1, B2, C1, C2, D1, and D2.
Data1	The Data1 list allows you to configure the output. The available choices are A1, A2, B1, B2, C1, C2, D1, and D2.
Data2	The Data2 list allows you to configure the output. The available choices are A1, A2, B1, B2, C1, C2, D1, and D2.

NOTE. You cannot exit the dialog box unless each of the clock and data selections are unique.

7. To connect the DUT, click **Tests > Connect**. [Click here](#) for information on how to make connections.

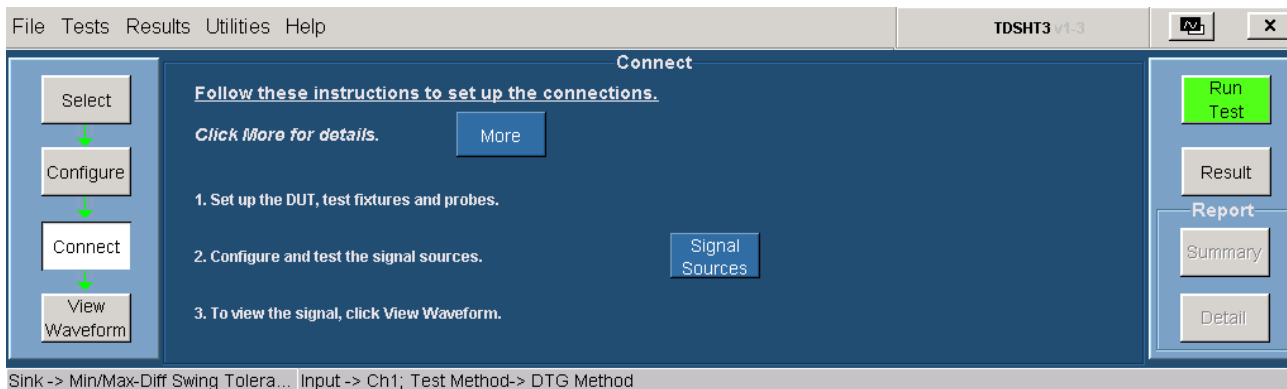

8. To configure and test the GPIB connection to the DTG, click **Signal Sources**. The Signal Sources Setup dialog box appears.

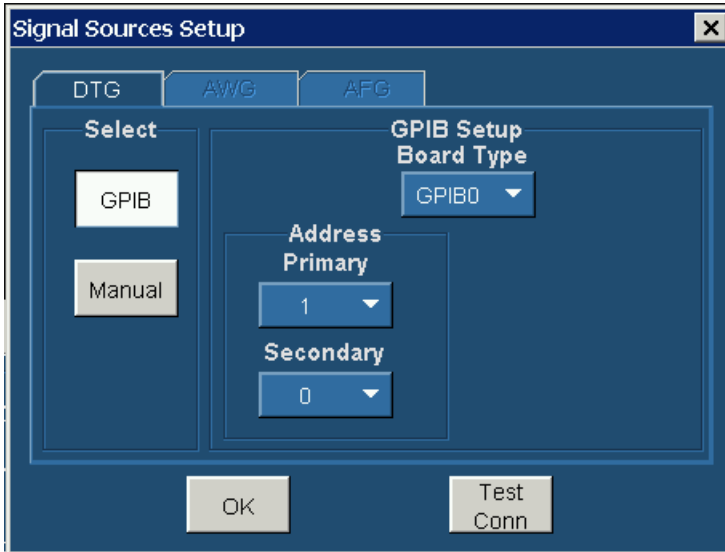

9. In the select pane, click **GPIB**. Configure the appropriate GPIB board number. [Click here](#) for more information.
10. To test both the connection and the DTG GPIB configuration, click **Test Conn**.
11. Because no signal is connected to the oscilloscope, you cannot view the waveform for the min-diff sensitivity test.

NOTE. To run the test successfully, ensure that the Bus Timing parameter is set to 2 μ sec on your GPIB board configuration. For more details, [click here](#).

12. Click **Run Test** to perform the test. The TDSHT3 HDMI Compliance Test Software sets up the oscilloscope and conducts the test. Follow the instructions in the dialog box. Depending on your answer, a series of dialog boxes may prompt you for your input.
13. If you successfully run the test, the software makes Result available automatically and displays the result summary. You can also view the report configuration details in the result pane.

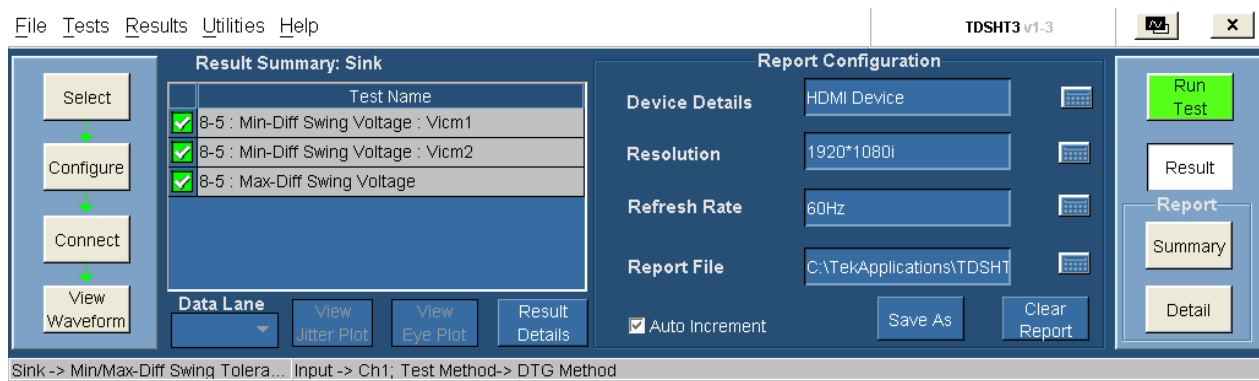

Option	Description
Test Name	The Test Name box displays the test id, test name, VIdm, and lane.
Status	Status indicates the status of the test as Pass, Fail, or Error.
Result Details	Click Result Details to display the details of the result.

14. You can set the report details to identify and generate the report automatically. You can set a default report file.

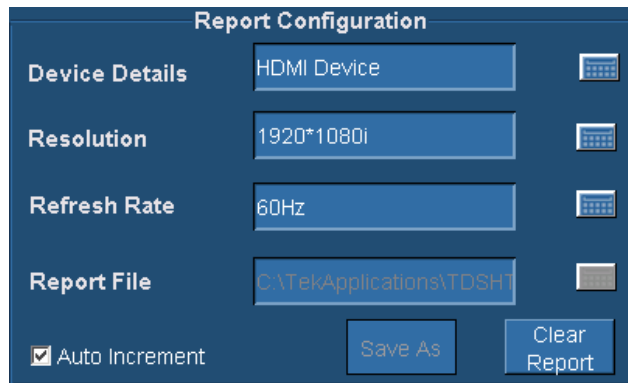

In the report configuration pane, you can configure the following parameters

Category	Description
Device Details	The Device Details box allows you to specify the device-related information on which the test is conducted.
Resolution	The Resolution box allows you to specify the resolution on which the test is conducted.
Refresh Rate	The Refresh Rate box allows you to specify the refresh rate at which the test is conducted.
Report File	The Report File box allows you to specify the path and the file where the generated report will be saved. However, a default file name and path already exists.
Auto Increment	Select the Auto Increment check box to generate a new report. Selecting this option does not overwrite the existing report. However, it adds the date and time to the existing file name.
Save As	Click Save As to save the generated reports. The Save File dialog box is displayed. You can enter a file name and save the report.
Clear Report	Click Clear Report to clear all the results and records of the earlier tests.

15. In the result summary pane, click **Result Details** to display the details of the result.

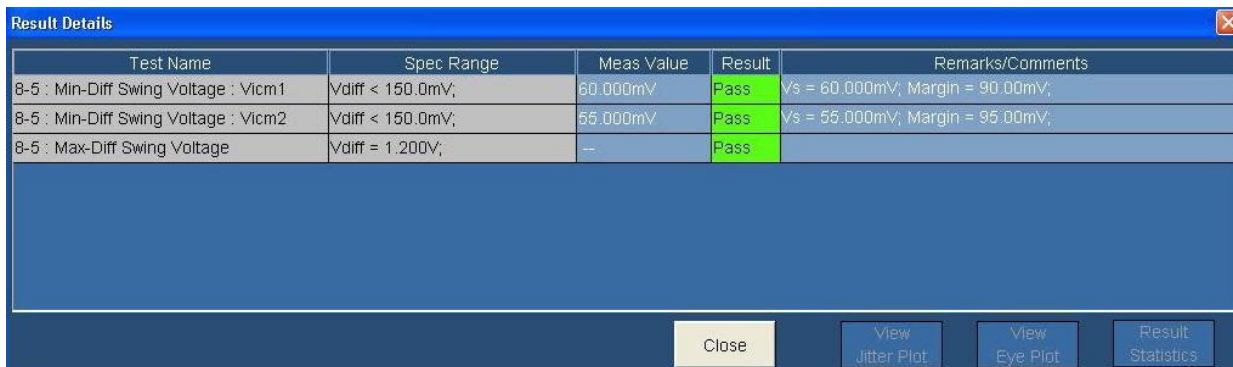

Options	Description
Test Name	The Test Name column displays the test id, test name, Vicm, and lane.
Spec Range	The Spec Range column displays the HDMI standards and test specifications limit for the test.
Meas Value	The Meas Value column displays the measured value in mV.
Result	The Result column displays the status of the test as Pass, Fail, or Error.
Remarks/Comments	The Remarks/Comments column displays the relevant details, for example, Vswing, and Margin. If the test could not be run, then an error code appears.
Close	Click Close to quit the Result Details dialog box.

Jitter Tolerance

This test allows you to confirm that the maximum allowed TMDS clock jitter is supported by the Sink DUT.

The signal degradation of typical passive copper cables increases with the frequency and the length of the cable. To recover data from such cables, the TDSHT3 applies the reference cable equalizer (as specified in the HDMI specifications 1.3) automatically to the jitter tolerance measurement when the clock frequency is more than 165 MHz.

To use the DTG test method, you will need one supported oscilloscope, two differential probes, one digital timing generator (DTG), one arbitrary waveform generator (AWG), one DC power supply, 12 SMA cables, two bias-tees, one cable emulator, one GPIB controller, one TPA-R-DI, one TPA-R-TDR, and TTC modules.

1. On the menu bar, click **Tests > Select > Sink**.
2. In the differential tests pane, select the Jitter Tolerance check box.

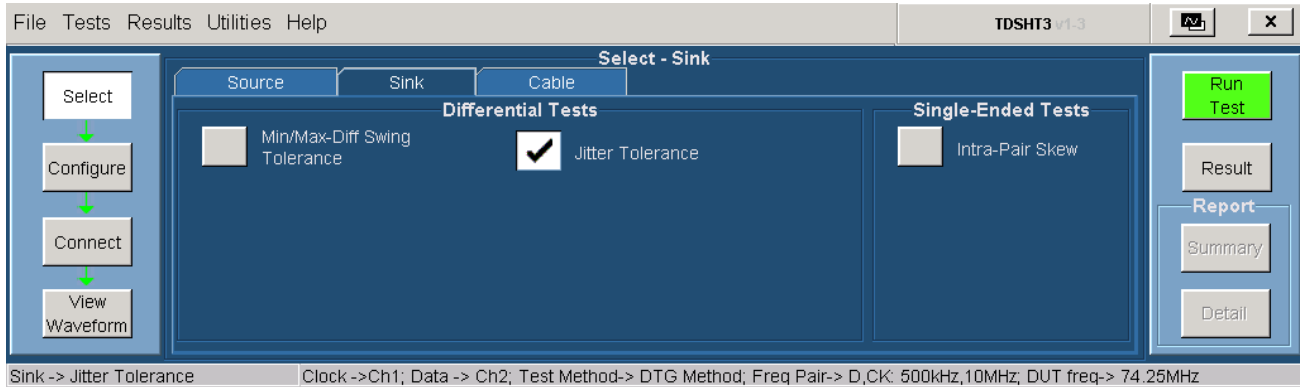

3. To change the configuration settings, click **Tests > Configure**. For most tests, you can use the factory default configuration. However, you can change the values by using the [virtual keyboard](#) or the [general purpose knob](#) on the oscilloscope front panel. Using the File menu, you can also restore the factory defaults or save and recall your own configuration settings. It is recommended that you save the configuration settings before you choose to select Recall Default or close the application.

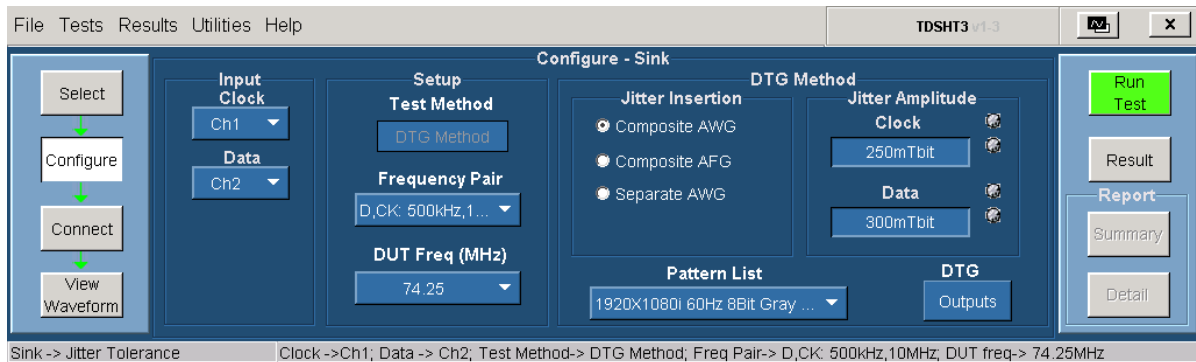

4. In the Input pane, you have the following options:

Configure parameter	Description
Clock	Clock indicates the channel to which you will connect the HDMI clock signal. The available choices are Ch1, Ch2, Ch3, and Ch4.
Data	Data indicates the channel to which you will connect the HDMI data signal. The available choices are Ch1, Ch2, Ch3, and Ch4.

5. In the Setup pane, set the following options:

Configure parameter	Description
Frequency Pair	In the Frequency Pair list, click the desired value for the jitter tolerance tests. The available choices are D, Ck: 500 KHz, 10 MHz and D, Ck: 1 MHz, 7 MHz, and Both. If you select Both, the test is run for both the frequency pairs.
DUT Freq (MHz)	In the DUT Freq (MHz) list, select the frequency value for the DUT. The available choices depend upon the selected test method.

6. In the DTG Method pane, you have the following options:

Configure parameter	Description
Jitter Insertion	
Composite AWG	Select AWG to insert composite jitter using an AWG. NOTE. <i>In composite jitter, both clock and data jitter frequency components are added to the clock signal.</i>
Composite AFG	Select AFG to insert composite jitter using an AFG. NOTE. <i>In composite jitter, both clock and data jitter frequency components are added to the clock signal.</i>
Separate AWG	Select AWG to insert separate jitter. NOTE. <i>In separate jitter insertion, clock jitter is added to the clock signal and data jitter is added to the data signal.</i>
Jitter Amplitude	
Clock	Set the amplitude of the clock jitter. By default the value is set to the value specified in the HDMI standards. The minimum and maximum value of clock are 150 mTbit and 500 mTbit respectively.
Data	Set the amplitude of the data jitter. By default the value is set to the value specified in the HDMI standards. The minimum and maximum value of data are 150 mTbit and 500 mTbit respectively.
Pattern List	Select the DTG pattern file from the drop-down list for the selected DUT frequency.
DTG	
Outputs	Click outputs to display a dialog box where you can set unique Clock, Data0, Data1, and Data2 outputs.

7. The DTG Outputs dialog box for DTG method has the following options:

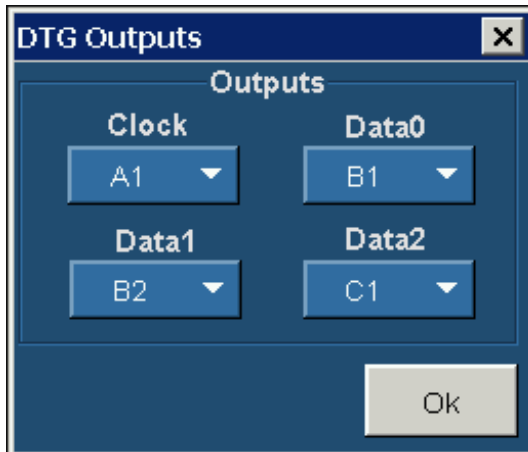

Configure parameter	Description
Clock	The Clock list allows you to configure the clock output. The available choices are A1, A2, B1, B2, C1, C2, D1, and D2.
Data0	The Data0 list allows you to configure the Data0 output. The available choices are A1, A2, B1, B2, C1, C2, D1, and D2.
Data1	The Data1 list allows you to configure the Data1 output. The available choices are A1, A2, B1, B2, C1, C2, D1, and D2.
Data2	The Data2 list allows you to configure the Data2 output. The available choices are A1, A2, B1, B2, C1, C2, D1, and D2.

8. To connect the DUT, click **Tests > Connect**. [Click here](#) for information on how to make connections.

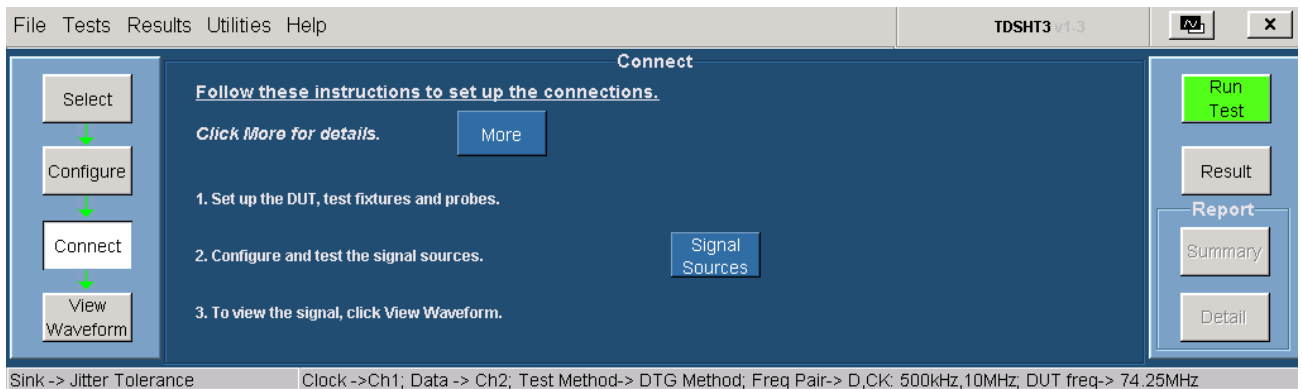

9. To configure and test the GPIB connection, click **Signal Sources**. The Signal Sources Setup dialog box appears.

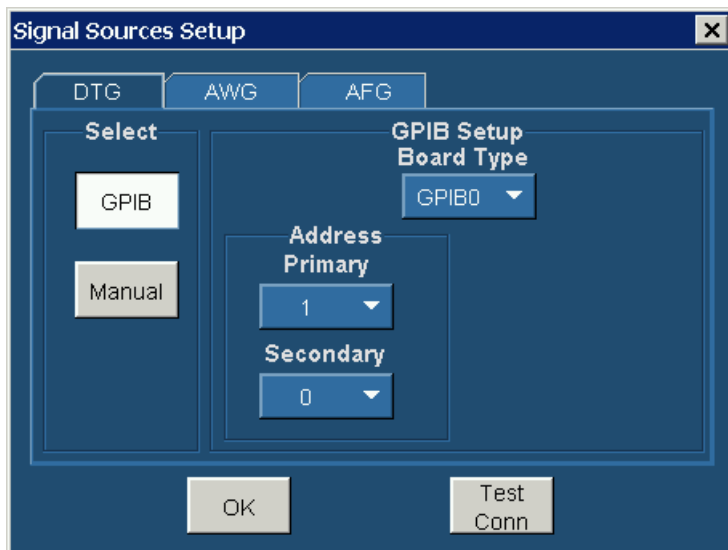

10. In the select pane, click **GPIB**. Configure the appropriate GPIB board number. [Click here](#) for more information.
11. To test the connection and the GPIB configuration, click **Test Conn**.
12. Because no signal is connected to the oscilloscope, you cannot view the waveform for the jitter tolerance test.

NOTE. To run the test successfully, ensure that the *Bus Timing* parameter is set to 2 μ sec on your GPIB board configuration. For more details, [click here](#).

13. Click **Run Test** to perform the test. The TDSHT3 HDMI Compliance Test Software sets up the oscilloscope and conducts the test.
14. Follow the instructions in the Sink Jitter Tolerance dialog box. Click **OK**. The Connect Sink Device dialog box for low frequency appears as follows.

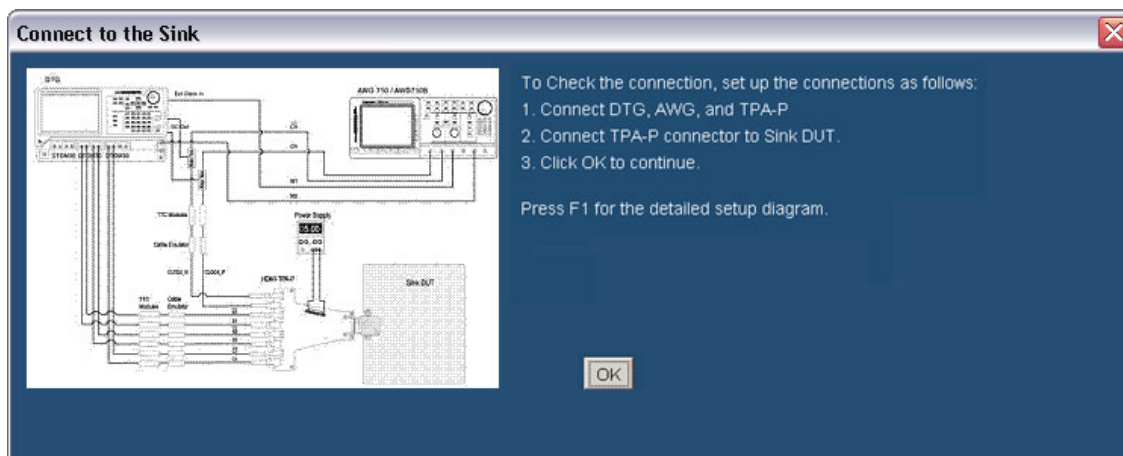

The Connect Sink Device dialog box for high frequency appears as follows.

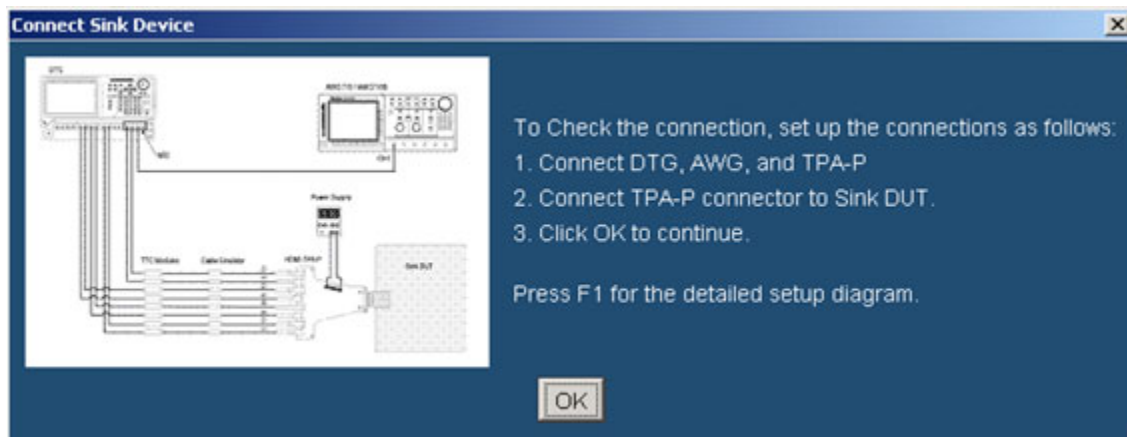

15. Follow the instructions in the Connect Sink Device dialog box. Click **OK**. The test runs, displaying a progress indicator. The Confirm Sink Device Support dialog box appears.

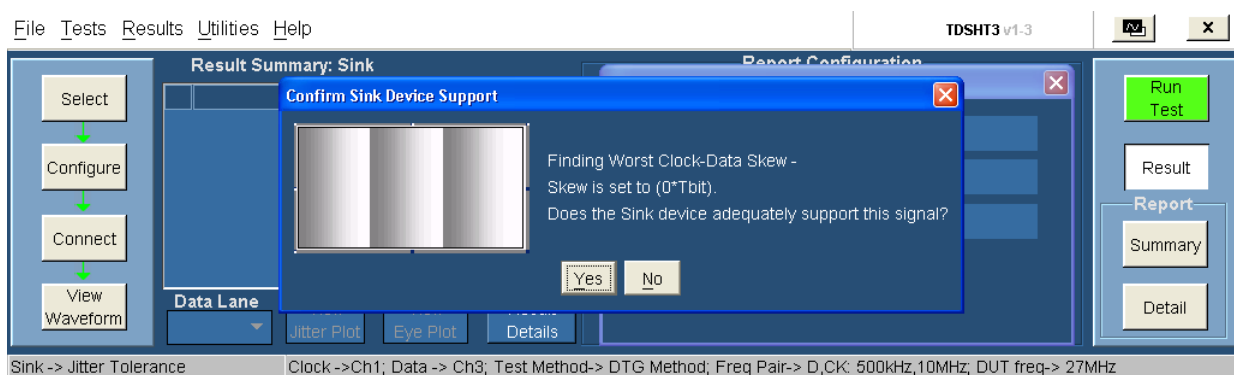

16. Follow the instructions in the dialog box. Depending on your answer, a series of dialog boxes may prompt you for your input.

17. If you successfully run the test, the software calculates the jitter values and displays the results. The software makes Result available automatically and displays the result summary. You can also view the report configuration details in the result pane.

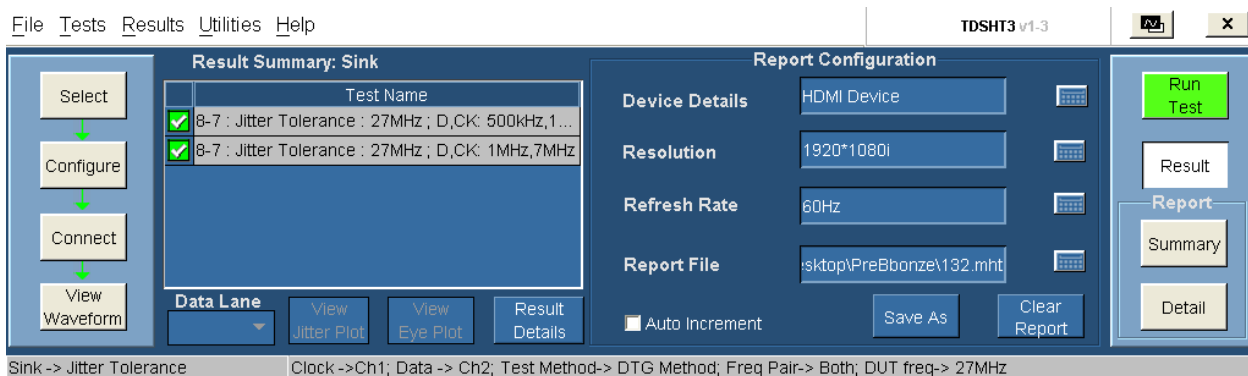

Option	Description
Test Name	The Test Name box displays the test id, test name, and selected lanes.
Status	Status indicates the status of the test as Pass, Fail, or Error.
Result Details	Click Result Details to display the details of the result.

18. You can set the report details to identify and generate the report automatically. You can set a default report file.

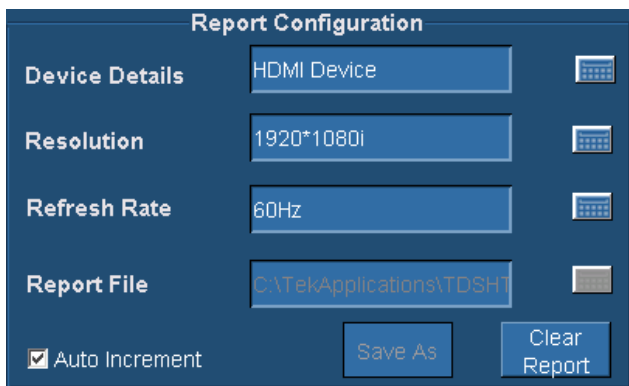

In the report configuration pane, you can configure the following parameters:

Category	Description
Device Details	The Device Details box allows you to specify the device-related information on which the test is conducted.
Resolution	The Resolution box allows you to specify the resolution on which the test is conducted.
Refresh Rate	The Refresh Rate box allows you to specify the refresh rate at which the test is conducted.
Report File	The Report File box allows you to specify the path and the file where the generated report will be saved. However, a default file name and path already exists.

Category	Description
Auto Increment	Select the Auto Increment check box to generate a new report. Selecting this option does not overwrite the existing report. However, it adds the date and time to the existing file name.
Save As	Click Save As to save the generated reports. The Save File dialog box is displayed. You can enter a file name and save the report.
Clear Report	Click Clear Report to clear all the results and records of the earlier tests.

19. In the result summary pane, click **Result Details** to display the details of the result.

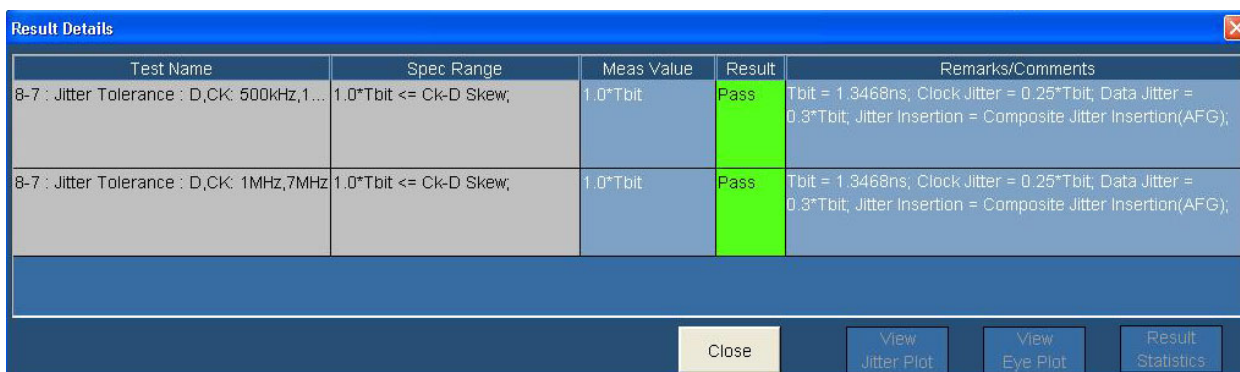

Options	Description
Test Name	The Test Name column displays the test id, test name, and selected lanes.
Spec Range	The Spec Range column displays the HDMI standards and test specifications limit for the test.
Meas Value	The Meas Value column displays the measured value in mV.
Result	The Result column displays the status of the test as Pass, Fail, or Error.
Remarks/Comments	The Remarks/Comments column displays the relevant details, for example, Vswing, and Margin. If the test could not be run, then an error code appears.
Close	Click Close to quit the Result Details dialog box.

Intra-Pair Skew (Sink)

This test allows you to confirm that the maximum allowed timing skew within each TMDS pair is supported by the Sink DUT.

To use the DTG test method, you will need one supported oscilloscope, one differential probe, one cable emulator, one TPA-P-DI fixture, one digital timing generator (DTG), one DC power supply, eight SMA cables, one GPIB controller, and one TPA-P-TDR fixture.

1. On the menu bar, click **Tests > Select > Sink**.
2. In the single-ended tests pane, select the Intra-Pair Skew check box.

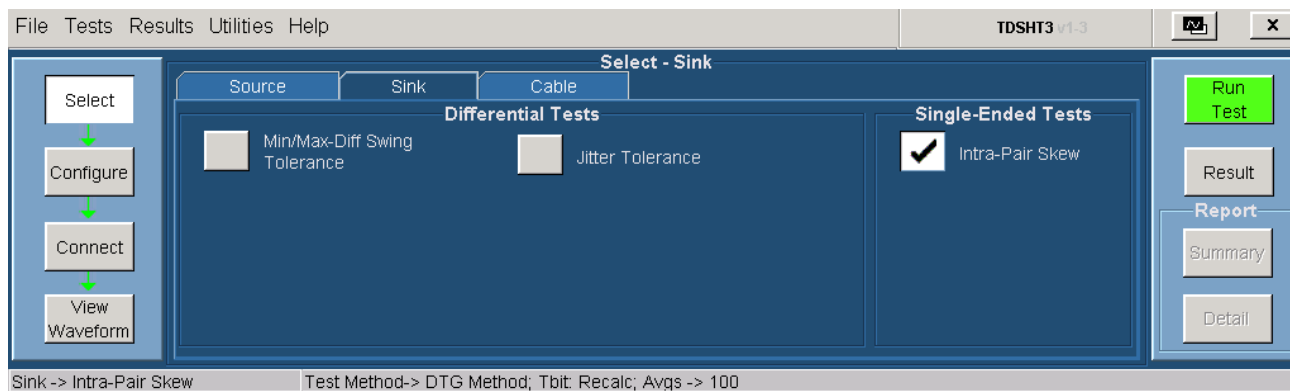

3. To change the configuration settings, click **Tests > Configure**. For most tests, you can use the factory default configuration. However, you can change the values by using the [virtual keyboard](#) or the [general purpose knob](#) on the oscilloscope front panel. Using the File menu, you can also restore the factory defaults or save and recall your own configuration settings. It is recommended that you save the configuration settings before you choose to select Recall Default or close the application.

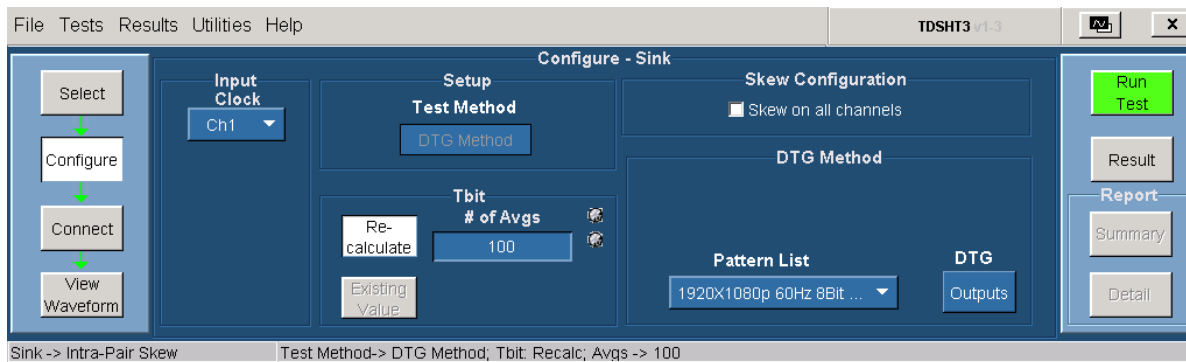

NOTE. The default configuration is to introduce skew on a single channel (Clock). If you want to calculate the intra-pair skew for all channels, then connect the desired channel to A1 and A2. For example, to calculate the intra-pair skew of Data0, assign A1 to Data0 and B1 to Clock. Make the appropriate changes in the test connections.

4. In the Input pane, you have the following option:

Configure parameter	Description
Clock	Clock indicates the channel to which you will connect the HDMI clock signal. The available choices are Ch1, Ch2, Ch3, and Ch4.

5. In the Tbit pane, you have the following options:

Configure parameter	Description
# of Avgs	In the # of Avgs box, enter the desired number of periods that are considered to calculate Tbit. The default value is 100.
Re-calculate	Click Re-calculate to recalculate the Tbit value.
Existing Value	Click Existing Value to use the previously calculated Tbit value.

6. In the Skew Configuration pane, you have the following option:

Configure parameter	Description
Skew on all channels	Select the skew on all channels to set the skew on all the channels. This way skew will be introduced on Clock, D0, D1, and D2. All the four DTGM30 modules are required for this option. If this option is not selected, the skew is set on one channel.

NOTE. The four DTGM modules can be connected as follows: Clock +ve to A1 and Clock -ve to A2, D0 +ve to B1 and D0 -ve to B2, D1 +ve to C1 and D1 -ve to C2, D2 +ve to D1 and D2 -ve to D2.

7. In the DTG Method pane, you have the following options:

Configure parameter	Description
Pattern List	Select the DTG pattern file from the drop-down list.
Outputs	Click outputs to display a dialog box where you can set Clock, Data0, Data1, and Data2 outputs.

8. In the DTG Method pane, the Outputs dialog box has the following options:

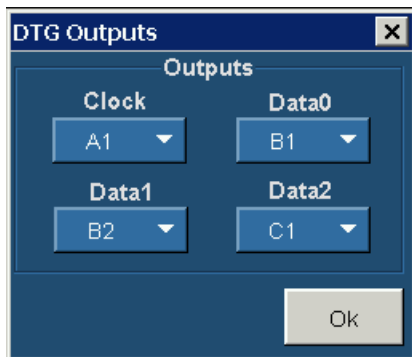

Configure parameter	Description
Clock	The Clock list allows you to configure the clock output. The available choices are A1, A2, B1, B2, C1, C2, D1, and D2.
Data0	The Data0 list allows you to configure the Data0 output. The available choices are A1, A2, B1, B2, C1, C2, D1, and D2.
Data1	The Data1 list allows you to configure the Data1 output. The available choices are A1, A2, B1, B2, C1, C2, D1, and D2.
Data2	The Data2 list allows you to configure the Data2 output. The available choices are A1, A2, B1, B2, C1, C2, D1, and D2.

NOTE. You cannot exit the dialog box unless each of the clock and data values are unique.

9. To connect the DUT, click **Tests > Connect**. [Click here](#) for information on how to make connections.

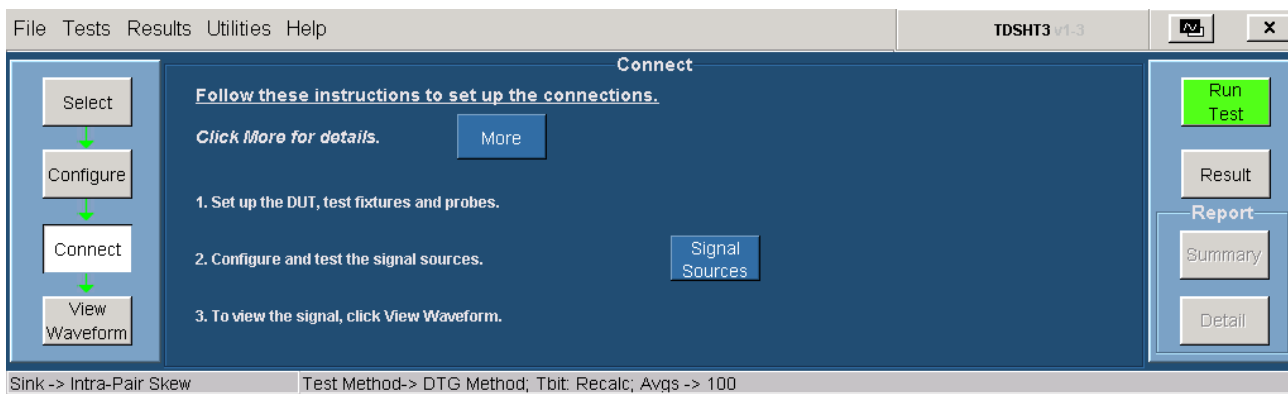

10. To configure and test the GPIB connection, click **Signal Sources**. The Signal Sources Setup dialog box appears.

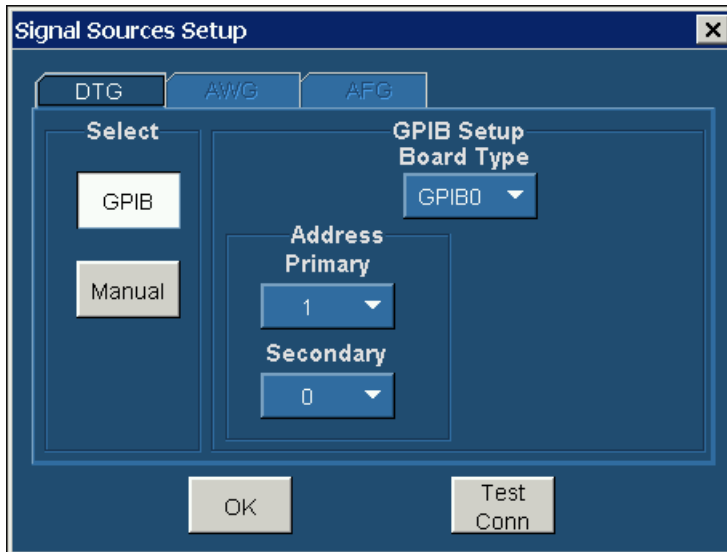

11. In the select pane, click **GPIB**. Configure the appropriate GPIB board number. [Click here](#) for more information.
12. To test the connection and the GPIB configuration, click **Test Conn**.
13. Click **Run Test** to perform the test. The TDSHT3 HDMI Compliance Test Software sets up the oscilloscope and conducts the test. Follow the instructions in the dialog box. Depending on your answer, a series of dialog boxes may appear asking for your input.
14. If you successfully run the test, the software makes Result available automatically and displays the result summary. You can also view the report configuration details in the result pane.

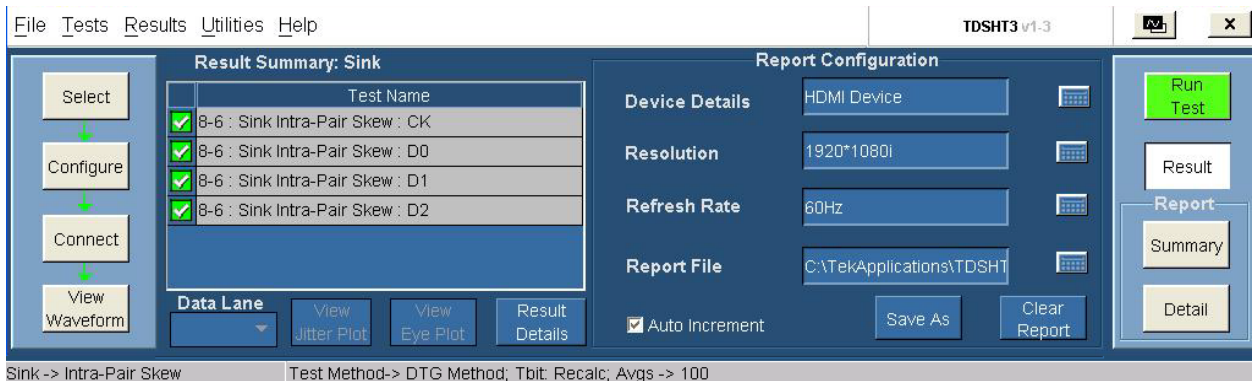

Options	Description
Test Name	The Test Name box displays the test id, test name, and selected names.
Status	Status indicates the status of the test as Pass, Fail, or Error.
Result Details	Click Result Details to display the details of the result.

15. You can set the report details to identify and generate the report automatically. You can set a default report file.

In the report configuration pane, you can configure the following parameters:

Category	Description
Device Details	The Device Details box allows you to specify the device-related information on which the test is conducted.
Resolution	The Resolution box allows you to specify the resolution on which the test is conducted.
Refresh Rate	The Refresh Rate box allows you to specify the refresh rate at which the test is conducted.
Report File	The Report File box allows you to specify the path and the file where the generated report will be saved. However, a default file name and path already exists.
Auto Increment	Select the Auto Increment check box to generate a new report. Selecting this option does not overwrite the existing report. However, it adds the date and time to the existing file name.
Save As	Click Save As to save the generated reports. The Save File dialog box is displayed. You can enter a file name and save the report.
Clear Report	Click Clear Report to clear all the results and records of the earlier tests.

16. In the result summary pane, click **Result Details** to display the details of the result.

Test Name	Spec Range	Meas Value	Result	Remarks/Comments
8-6 : Sink Intra-Pair Skew : CK	0.4*Tbit < Intra Pair Skew;	>0.6*Tbit	Pass	Tbit = 673.35ps;
8-6 : Sink Intra-Pair Skew : D0	0.4*Tbit < Intra Pair Skew;	>0.6*Tbit	Pass	Tbit = 673.35ps;
8-6 : Sink Intra-Pair Skew : D1	0.4*Tbit < Intra Pair Skew;	>0.6*Tbit	Pass	Tbit = 673.35ps;
8-6 : Sink Intra-Pair Skew : D2	0.4*Tbit < Intra Pair Skew;	>0.6*Tbit	Pass	Tbit = 673.35ps;

Buttons: Close, View Jitter Plot, View Eye Plot, Result Statistics

Options	Description
Test Name	The Test Name column displays the test id, test name, and selected names.
Spec Range	The Spec Range column displays the HDMI standards and test specifications limit for the test.
Meas Value	The Meas Value column displays the measured value.
Result	The Result column displays the status of the test as Pass, Fail, or Error.
Remarks/Comments	The Remarks/Comments column displays the relevant details, for example, Tbit, Vswing, and Margin. If the test could not be run, then an error code appears.
Close	Click Close to quit the Result Details dialog box.

Eye Diagram (Cable)

This test allows you to confirm that the Cable assembly outputs a compliant data eye. You can check the input test signal at TP1 and verify the output of the cable for compliance at TP2.

The signal degradation of typical passive copper cables increases with the frequency and the length of the cable. To recover data from such cables, the TDSHT3 applies the reference cable equalizer (as specified in the HDMI specifications 1.3) automatically to the eye diagram measurement when the clock frequency is more than 165 MHz.

You will need one supported oscilloscope, two/four differential probes, one digital timing generator (DTG), one arbitrary function generators (AFG), one GPIB controller, one DC power supply 3.3 V, eight SMA cables, one TPA-R-DI fixture, and one TPA-R-TDR fixture.

1. On the menu bar, click **Tests > Select > Cable**.
2. In the differential tests pane, select the Eye Diagram check box.

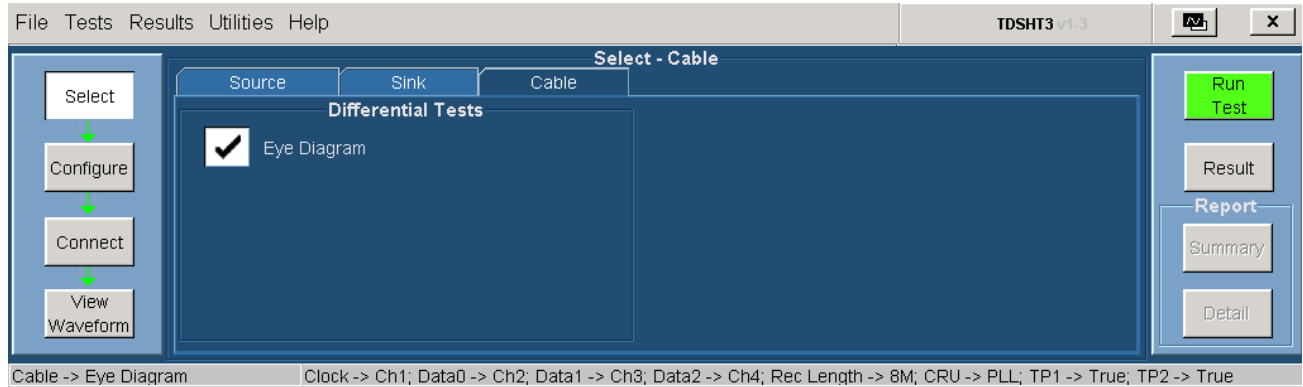

3. To change the configuration settings, click **Tests > Configure**. For most tests, you can use the factory default configuration. However, you can change the values by using the virtual keyboard or the general purpose knob on the oscilloscope front panel. Using the File menu, you can also restore the factory defaults or save and recall your own configuration settings. It is recommended that you save the configuration settings before you choose to select Recall Default or close the application.

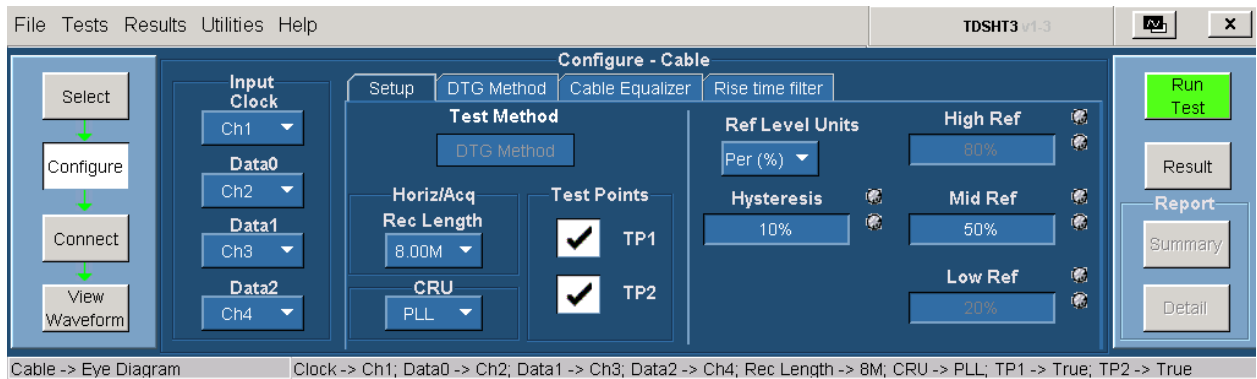

4. In the Input pane, you have the following options:

Configure parameter	Description
Clock	Clock indicates the source channel to which you will connect the HDMI clock input lane. The available choices are Ch1, Ch2, Ch3, and Ch4.
Data0	Data0 indicates the source channel to which you will connect the HDMI data0 input lane. The available choices are Ch1, Ch2, Ch3, Ch4, and Not Conn.
Data1	Data1 indicates the source channel to which you will connect the HDMI data1 input lane. The available choices are Ch1, Ch2, Ch3, Ch4, and Not Conn.
Data2	Data2 indicates the source channel to which you will connect the HDMI data2 input lane. The available choices are Ch1, Ch2, Ch3, Ch4, and Not Conn.

5. On the **Setup** tab, in the Horiz/Acq pane, you have the following options:

Configure parameter	Description
Rec Length	In the Rec Length box, enter the desired record length value for the eye tests.
CRU	The CRU list allows you to configure the Clock Recovery Unit. The available choices are PLL, Raw, and Ideal. The default value is first order PLL and is used for compliance testing. Raw and Ideal are used for analysis.

6. On the **Setup** tab, in the Test Points pane, you have the following options:

Configure parameter	Description
TP1	TP1 represents the first test point. Feed the worst possible compliant signal at TP1. By default, the TP1 check box is selected.
TP2	TP2 represents the second test point. The worst possible compliant signal fed at TP1 is transmitted through the cable. The same signal is tested at TP2 with the TP2 specification. By default, the TP2 check box is selected.

7. On the **Setup** tab, you also have the following options:

Configure parameter	Description
Ref Level Units	The Ref Level Units list allows you to set the reference level units to either Per (%) or Abs. Per (%) indicates that the reference levels are a percentage of the Vswing value. Abs indicates that the reference levels are absolute voltage values.
Hysteresis	In the Hysteresis box, enter the desired hysteresis percent value. The default value is 10 percent.
Mid Ref	In the Mid Ref box, enter the desired mid reference voltage value. The default value is 50 percent.

8. On the **DTG Method** tab, you have the following options:

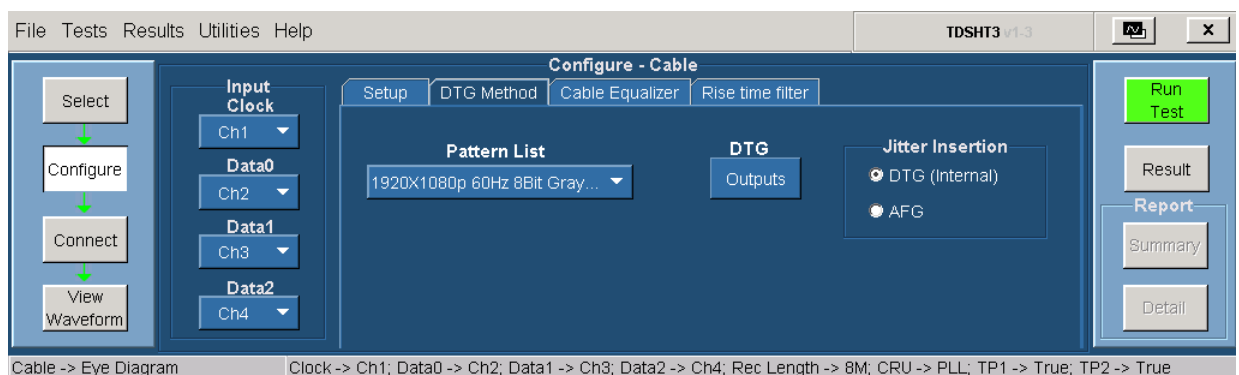

Configure parameter	Description
Pattern List	Select the DTG pattern file from the drop-down list.
Outputs	Click outputs to display a dialog box where you can set Clock, Data0, Data1, and Data2 outputs.
Jitter Insertion	
DTG (Internal)	Select DTG to insert jitter using a DTG.
AFG	Select AFG to insert jitter using an AFG.

9. In the DTG Outputs dialog box, you have the following options:

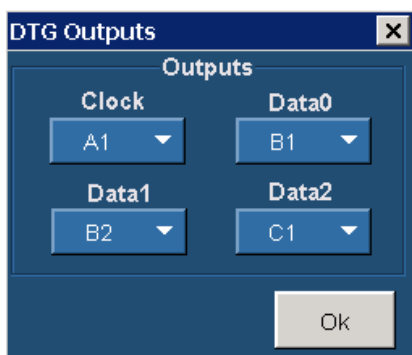

Configure parameter	Description
Clock	The Clock list allows you to configure the output. The available choices are A1, A2, B1, B2, C1, C2, D1, and D2.
Data 0	The Data 0 list allows you to configure the output. The available choices are A1, A2, B1, B2, C1, C2, D1, and D2.
Data 1	The Data 1 list allows you to configure the output. The available choices are A1, A2, B1, B2, C1, C2, D1, and D2.
Data 2	The Data 2 list allows you to configure the output. The available choices are A1, A2, B1, B2, C1, C2, D1, and D2.

NOTE. You cannot exit the dialog box unless each of the clock and data values are unique.

10. On the **Cable Equalizer** Configuration tab, you have the following options:

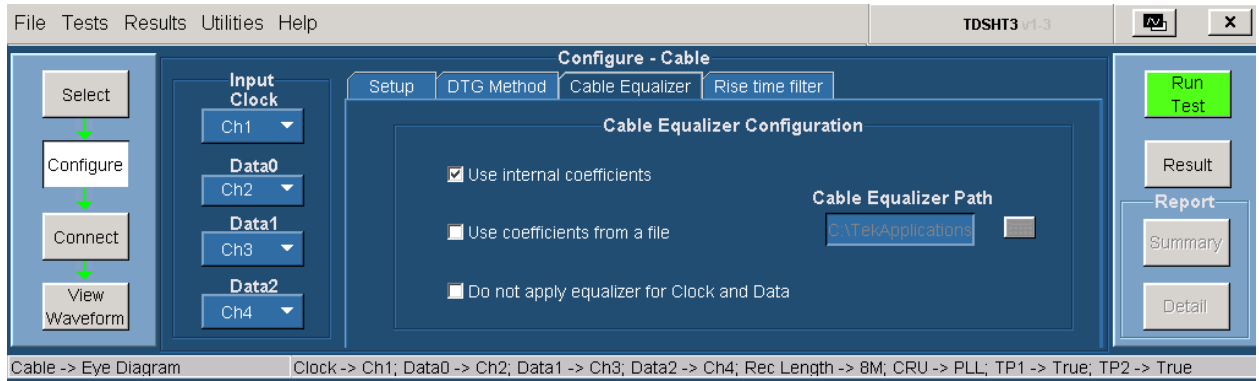

Configure options	Description
Use internal coefficients	Select the Use Internal coefficients check box to use the internal coefficients that are already available (these coefficients are in accordance with the CTS).
Use coefficients from a file	Select the Use coefficients from a file check box to use the coefficients from a file. You can browse the cable equalizer file from the Cable Equalization Path option.
Do not apply equalizer for Clock and Data	Select Do not apply equalizer for Clock and Data check box if you do not want to apply cable equalization.

11. On the Rise Time Filter Configuration tab, you have the following options:

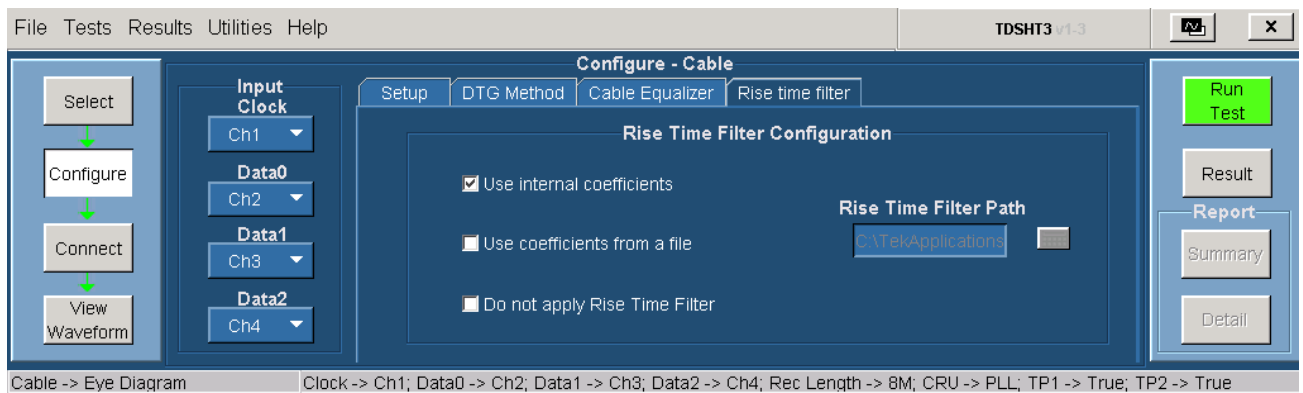

Configure options	Description
Use internal coefficients	Select the Use Internal coefficients check box to use the internal coefficients that are already available (these coefficients are in accordance with the CTS).
Use coefficients from a file	Select the Use coefficients from a file check box to use the coefficients from a file. You can browse to the rise time filter file from the Rise Time Filter Path.
Do not apply equalizer for Clock and Data	Select Do not apply rise time filter for Clock and Data check box if you do not want to filter.

12. To connect the DUT, click Tests > Connect. [Click here](#) for information on how to make connections.

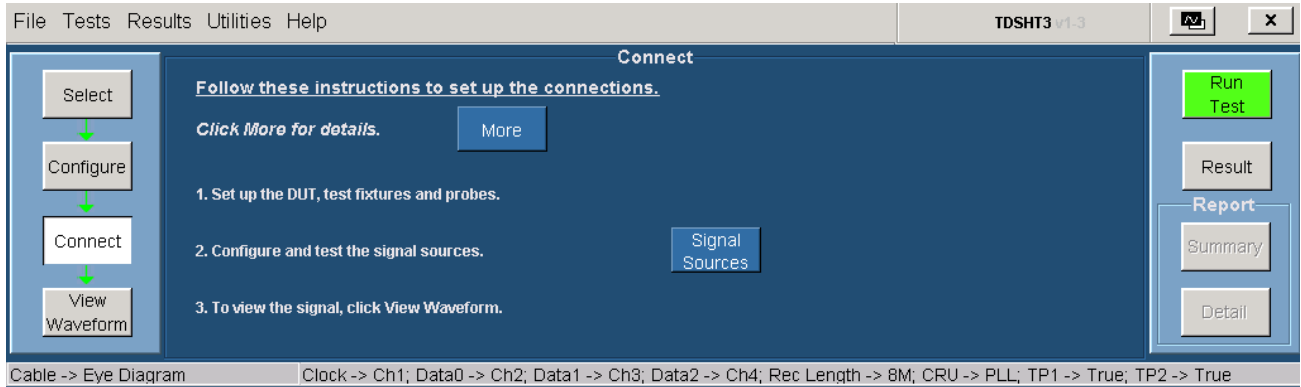

13. To configure and test the GPIB connection, click **Signal Sources**. The Signal Sources Setup dialog box appears.

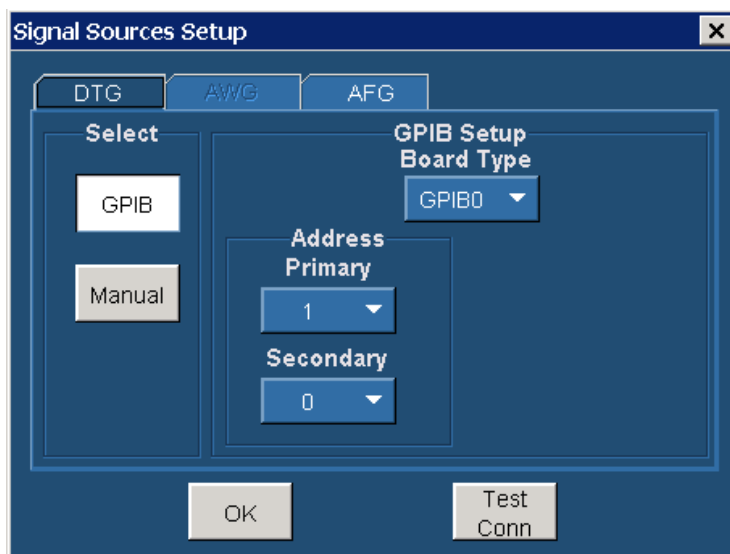

14. In the select pane, click **GPIB**. Configure the appropriate GPIB board number. [Click here](#) for more information.

15. To test the connection and the GPIB configuration, click **Test Conn**.

16. Because no signal is connected to the oscilloscope, you cannot view the waveform for the eye diagram test.

NOTE. To run the test successfully, ensure that the Bus Timing parameter is set to 2 μ sec on your GPIB board configuration. For more details, [click here](#).

17. Click **Run Test** to perform the test. The TDSHT3 HDMI Compliance Test Software sets up the oscilloscope and the test runs, displaying a progress indicator.

18. In the GPIB mode, the application automatically adjusts the jitter amplitude on DTG and displays the measured jitter value. Follow the on-screen instructions to enable you to re-adjust the jitter value. The software creates a worst eye and asks you to verify the worst eye. Follow the on-screen instructions. Depending on your answer, a series of dialog boxes may prompt you for your input.
19. If you have run the test successfully, the software makes Result available automatically and displays the eye diagram plot and the clock jitter plot for both TP1 and TP2. For more information on the plots, refer the section on the source eye diagram test and the source clock jitter test. You can also view both the result summary of the test and the report configuration in the result pane as shown in the following figure:

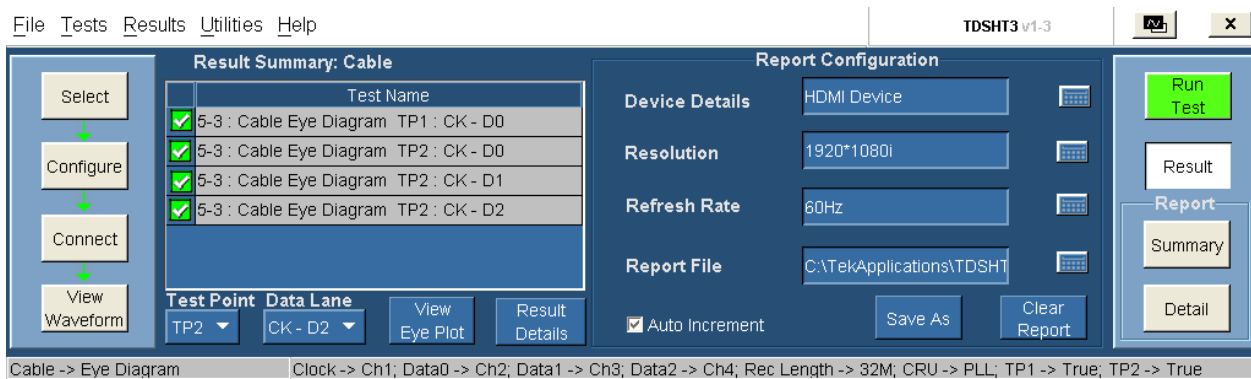

Options	Description
Test Name	The Test Name box displays the test id, test name, test point, and selected lanes.
Status	Status indicates the status of the test as Pass, Fail, or Error.
Test Point	You can check the input test signal at TP1 and verify the output of the cable for compliance at TP2. From the Test Point list, select either TP1 or TP2 to view the respective details.
Data Lane	Select the data lane pair for which to display the corresponding eye diagram plot. NOTE. This option is applicable only for TP2.
View Eye Plot	Click View Eye Plot to view the eye plot for the selected test point and data lane for the eye diagram test.
Result Details	Click Result Details to display the details of the result.

20. You can set the report details to identify and generate the report automatically. You can set a default report file.

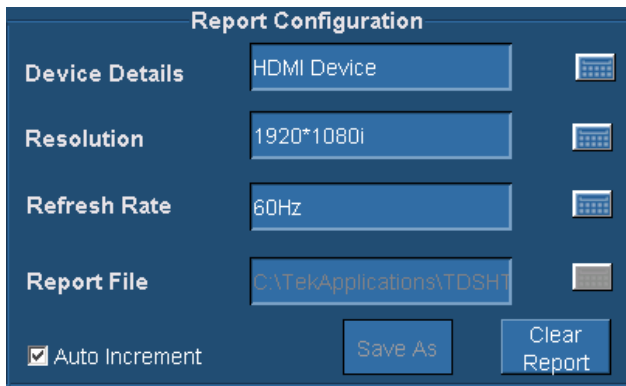

In the report configuration pane, you can configure the following parameters:

Category	Description
Device Details	The Device Details box allows you to specify the device-related information on which the test is conducted.
Resolution	The Resolution box allows you to specify the resolution on which the test is conducted.
Refresh Rate	The Refresh Rate box allows you to specify the refresh rate at which the test is conducted.
Report File	The Report File box allows you to specify the path and the file where the generated report will be saved. However, a default file name and path already exists.
Auto Increment	Select the Auto Increment check box to generate a new report. Selecting this option does not overwrite the existing report. However, it adds the date and time to the existing file name.
Save As	Click Save As to save the generated reports. The Save File dialog box is displayed. You can enter a file name and save the report.
Clear Report	Click Clear Report to clear all the results and records of the earlier tests.

21. In the result summary pane, click **Result Details** to display the details of the result.

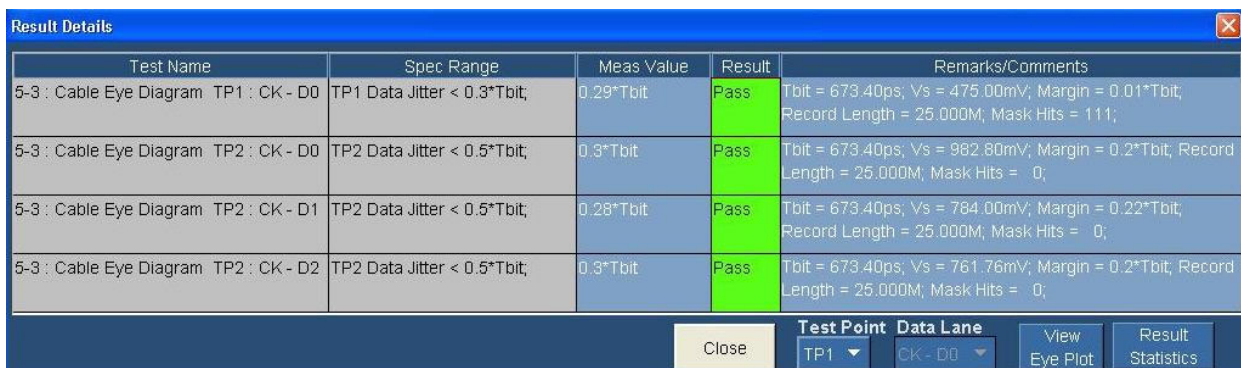

Options	Description
Test Name	The Test Name column displays the test id, test name, test point, and selected lanes.
Spec Range	The Spec Range column displays the HDMI standards and test specifications limit for the test.
Meas Value	The Meas Value column displays the measured value in mV.
Result	The Result column displays the status of the test as Pass, Fail, or Error.
Remarks/Comments	The Remarks/Comments column displays the relevant details, for example, Vswing, and Margin. If the test could not be run, then an error code appears.
Close	Click Close to quit the Result Details dialog box.
Test Point	You can check the input test signal at TP1 and verify the output of the cable for compliance at TP2. From the Test Point list, select either TP1 or TP2 to view the respective details.
Data Lane	Select the data lane pair for which to display the corresponding eye diagram plot. NOTE. <i>This option is applicable only for TP2.</i>
View Eye Plot	Click View Eye Plot to view the eye plot for for the selected test point and data lane for the eye diagram test.
Result Statistics	Click Result Statistics to display statistics based on the tests.

22. In the Result Details dialog box, click **Result Statistics** to display statistics based on the tests.

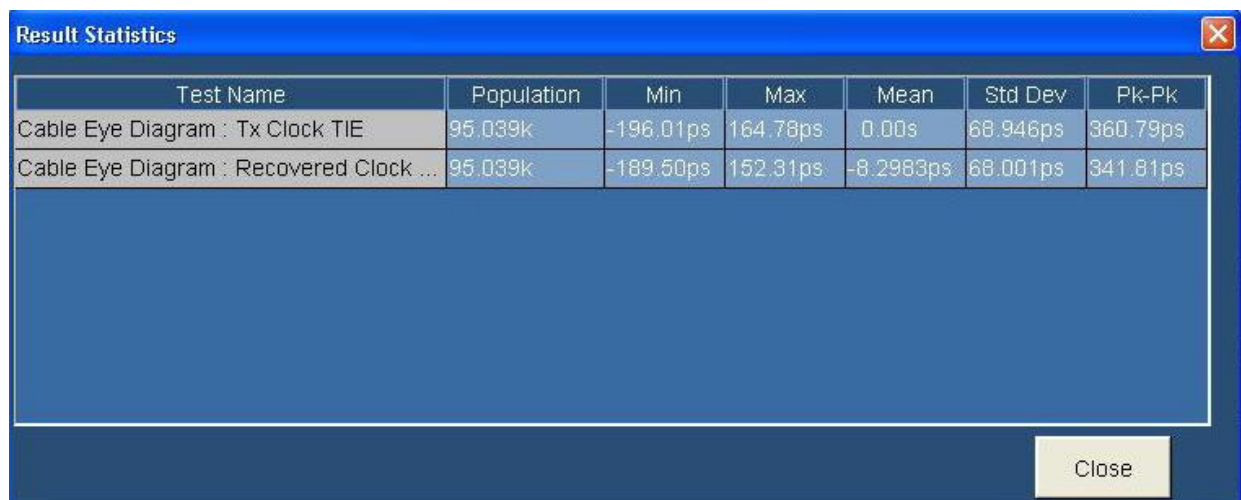

The software calculates statistics for each selected test, and logs the statistics on a cycle-by-cycle basis in a large waveform. The standard statistics are for the Maximum, Minimum, Mean, Standard Deviation, and Population.

Options	Description
Test Name	The Test Name column displays the test id, test name, test point, and selected lanes.
Population	The software calculates this statistic by using the following equation: Population (X) = N
Min	The software calculates this statistic by using the following equation: Min (X) = Lowest value of X
Max	The software calculates this statistic by using the following equation: Max (X) = Highest value of X
Mean	The software calculates this statistic by using the following equation: $Mean (X) = \bar{X} = \frac{1}{N} \sum_{n=1}^N X_n$
Std Dev	The software calculates this statistic by using the following equation: $Standard\ Deviation (X) = \sigma_x = \sqrt{\frac{1}{(N-1)} \sum_{n=1}^N (X_n - \bar{X})^2}$
Pk-Pk	The software calculates this statistic by using the following equation: Xppn = Max(X) – Min(X)
Close	Click Close to quit the Result Statistics dialog box.

Software CRU Technology

The HDMI specification mandates the Clock Recovery Unit (CRU) by using a Phase Locked Loop (PLL) with first order transfer function characteristics, to test both the jitter and the eye diagram. A PLL-based CRU implemented in hardware makes correlation of test results difficult due to differences in vendor-specific implementations. Software PLL techniques can extract clock and timing data from a serial data stream. The following method shows a practical and affordable way to satisfy the requirement:

PLL Characteristics

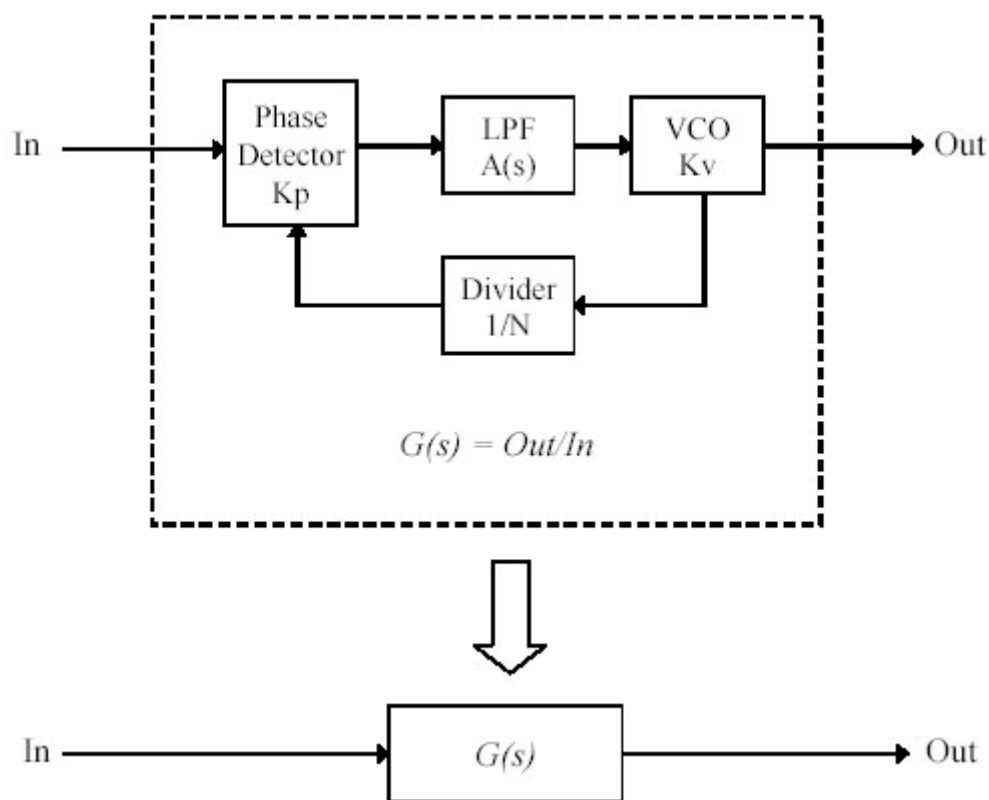

The diagram shows a simplified block diagram of generic phase-locked loop (PLL). A PLL consists of the Phase Detector (PD), Low Pass Filter (LPF), Voltage Controlled Oscillator (VCO), and Frequency Divider (FD).

The phase of the input signal is compared to the phase of FD output. The input of the FD is the output of VCO, whose frequency is controlled by the LPF output. The LPF output is a filtered form of the PD output. When the phase of FD output is leading compared to the input phase, the PD output changes to decrease the VCO frequency. Thus, the FD output will lag. Due to the effect of this feedback mechanism, the frequency of VCO is locked to N-times of the input frequency.

The LPF restricts the quick variation of the incoming signal, so that high frequency changes in the input phase are attenuated before they are transferred to consecutive functional blocks. Therefore, the VCO output represents the average phase of input signal even if the input signal does not have the constant phase rotation (frequency). Using this approach, the PLL circuitry recovers the clock information from the modulated input signal.

The transfer function from the input phase to the output phase is represented by following equation:

$$G(s) = \frac{\frac{Kp \cdot Kv \cdot H(s)}{s}}{1 + \frac{Kp \cdot Kv \cdot H(s)}{s \cdot N}} = \frac{N \cdot Kp \cdot Kv \cdot H(s)}{s \cdot N + Kp \cdot Kv \cdot H(s)}$$

where Kp and Kv are the sensitivity coefficients of PD and VCO respectively, and N is the division factor of FD. H(s) is the transfer function of LPF in the frequency domain.

Assuming that N, Kp, and Kv are constant, the function G(s) can be simplified as follows:

$$G(s) = \frac{K_2 \cdot H(s)}{s + K_1 \cdot H(s)}$$

Note that G(s) becomes the first order low-pass filter only when H(s) is constant, namely, when H(s) is non-dependent on the frequency. This means that H(s) is not a low-pass filter in this case. On the contrary, it is well known that the PLL is not stable without a low-pass filter in place of H(s). Therefore, the first order transfer function that is required by CRU for HDMI may not be realized by the PLL circuitry as shown in the earlier PLL Functional Block diagram.

Conventional Method

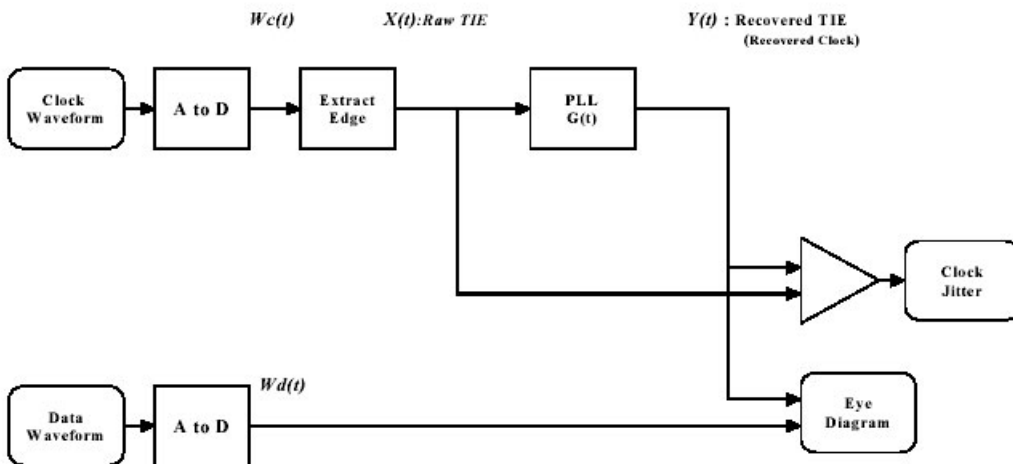

The diagram shows a simple PLL design for CRU, measuring both the clock jitter and eye diagram within a digital oscilloscope. The input signal is first converted to digital information with an A/D converter. The phase of the input signal is extracted by finding the rising (or falling) edges of the digitized signal. A digital simulation of an actual hardware PLL circuit may be realized because the input and output signals exist as just digital information. In this case, the voltage values at several points in the PLL circuit are expressed in the time domain, and are repetitively calculated to derive their time variation. The time interval of the calculation must be sufficiently small to retain the high precision of the simulation. Hence, it requires significant digital processing capability to simulate actual PLL within a reasonable amount of time.

In this method, the phase transfer function of the PLL is determined by the characteristics of the simulated components. As long as the simulation observes the laws of physics, the resultant transfer function does not differ from that of the actual hardware PLL circuit. Given the time to process the data in the simulation, using this method is not advisable. Hence, the first order transfer function to be realized by this method may not be useful either.

Another method to simulate a PLL in software is to use its time domain transfer function from the input phase error to output timing information. The impulse response is used as the time domain transfer function. In this case, given the input signal $X(t)$, the integral operation shown next gives the output signal $Y(t)$.

$$Y(t) = \int_{\tau=-\infty}^{\infty} X(\tau) \cdot G(\tau - t) d\tau$$

where $G(t)$ is the time domain representation of $G(s)$ mentioned in the previous section. This is called a convolution integral. In this case, the input signal is represented as discrete-time samples. The integration shown earlier should also be performed in discrete fashion as follows:

$$y(n) = \sum_{m=-\infty}^{\infty} g(m) \cdot x(n - m) = \sum_{m=-\infty}^{\infty} g(n - m) \cdot x(m)$$

There are two disadvantages in the time domain convolution method. One is that it still requires a huge number of multiplications and additions to calculate the values of all time points, as easily seen from the form of the equation above. Another is that it is not always practical to express the time domain transfer function as an explicit mathematical representation. In many cases, the human interpretation of the transfer function is made in frequency domain. Some means of conversion is required to derive the time domain response from the frequency domain characteristics. This requirement will complicate the design of the user interface.

It is important to mention that the first order transfer function characteristics can be realized by this convolution method, even though it has the difficulties described earlier. This method is inherently stable as far as an appropriate impulse response is adopted, because it does not include a feedback loop.

Proposed Method

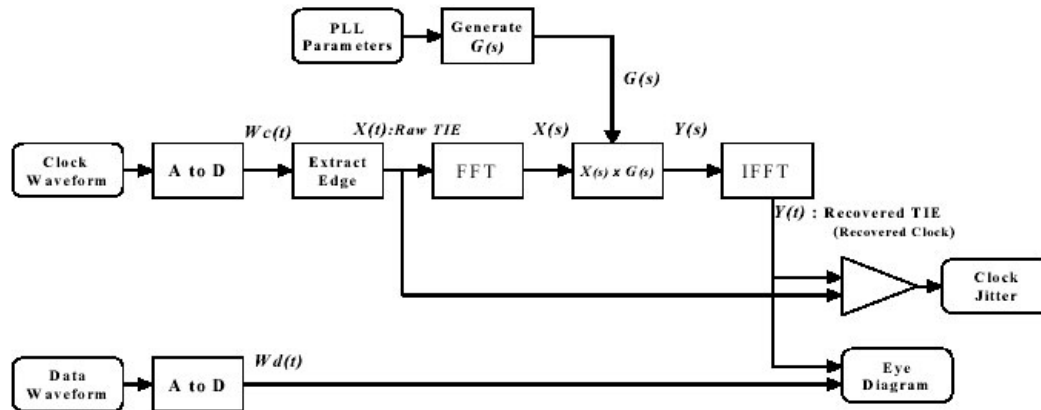

The PLL circuitry acts as a low-pass filter for incoming time information. In the frequency domain, the filter function is simply realized by multiplying of the frequency response coefficients to the input spectrum. The convolution integral in the time domain is equivalent to simple multiplication between frequency-domain functions derived by the Fourier Transform. If the time information and the PLL characteristics are transformed to frequency domain, the PLL processing becomes much easier than in the time domain.

$$Y(s) = G(s) \cdot X(s)$$

As seen in this equation, the calculation becomes one multiplication (though between complex numbers) per sample point. Hence, the demand for digital processing performance is very low.

After the filter function is performed, the time information of the output signal may be derived with inverse transformation. Using an FFT algorithm, the forward and inverse transformation can be executed in relatively short time compared to simulation in time domain. Thus, the total time to calculate the recovered clock can be significantly reduced.

Jitter Test

The jitter of the incoming clock signal is measured by statistically analyzing the time difference between the incoming and recovered clocks. The timing information of both signals is already retained in digital form, so the jitter calculation is simple and straightforward. Usually, the peak-to-peak jitter value and the standard deviation (RMS) jitter value are used for evaluating the signal quality.

$$J_{pp} = \Delta T_{\max} - \Delta T_{\min}$$

$$J_{\sigma} = \sqrt{\frac{\sum (\Delta T_n - \overline{\Delta T})^2}{N}}$$

Appropriate sample points should be chosen to measure the jitter for specific cases such as the clock-to-data jitter at the first bit. Such a requirement is addressed by specifying a rectangular area with time range of $[-T..+T]$ and voltage range of $[-V..+V]$.

To obtain an accurate test, a large number of samples are required. As the earlier area restriction reduces the number of measured samples, the capability to process more and more samples is desired. Using the proposed method, it becomes realistic to gather a huge amount of statistical information for a more precise test.

Eye Diagram

An eye diagram is the incoming data waveform repeatedly drawn with the recovered clock used as the time reference. The recovered clock is represented as time information. Hence, it may be used to derive the position where the input data waveform should be drawn. The resulting diagram will precisely indicate the true marginal area with which the reliability of data transmission is determined.

The vertical coordinate to draw the incoming waveform is determined by using the data value itself. Determine the horizontal coordinate (x) by the following equation:

$$X_{coord} = T_n - T_{ref}$$

where T_n is the time of incoming waveform, and T_{ref} is the time of the reference signal (the recovered clock signal).

Eye Diagram

This sequence explains the actions that the software takes while it performs an eye diagram test. For the procedure on how to make this test, see [eye diagram test procedure](#).

1. Connect TPA-P-DI to the Source DUT HDMI output connector.
2. Connect the differential probes to TMDS Clock and configure as trigger.
3. Connect the second differential probe to TMDS Data.
4. Configure the Source DUT to output the first supported video format.
5. Set up the oscilloscope as follows:
 - Set the memory length to at least 25 M points.
 - Set the single-shot trigger at the rising edge of TMDS Clock (50 percent).
 - Set the sample rate to ≥ 10 GS/s based on the oscilloscope.
 - Adjust the vertical scale to accommodate the waveform in six vertical divisions.
6. Capture the waveforms on the oscilloscope.

NOTE. Do not transfer the waveforms.

7. Perform software clock recovery as follows:
 - Find V_H and V_L of both clock and data.
 - Find 50 percent reference level of the clock.
 - Calculate the Software CRU filter as follows.
 $H(s) = 1/(1+s\tau)$, where $\tau = 40$ nsec.
 - Pass the TIE values through the filter (FFT and IFFT) $H(s) = 1/(1+s\tau)$, where $\tau = 40$ nsec .
 - Reconstruct the clock, and then create a bit clock (x10 clock) by using even up sampling.
8. Draw the eye diagram.
 - x10 clock is used for slicing.
 - Draw the eye diagram with $\frac{1}{2} UI + UI + \frac{1}{2} UI$ method. This ensures that all UIs are overlapped.
9. Create eye mask.
 - Calculate V_{SWING} by using V_H and V_L of the data.
 - Construct the mask co-ordinate by using T_{BIT} and V_{SWING} .
10. Position the mask in such a way that one of its left corners just touches the waveform.

11. If any other part of the waveform either touches or crosses the data eye, then it implies FAIL.
12. Calculate the data jitter by using the histogram technique. The histogram co-ordinates are $V_C \pm 5$ mV.
13. If data jitter is more than $(0.3 * T_{BIT})$, then it implies FAIL.
14. Repeat the test for all the remaining TMDS_DATA pairs.
15. Repeat the test for all supported pixel clock rates. Only one video format is required per pixel clock rate.

Duty Cycle

This sequence explains the actions that the software takes while it performs a duty cycle test. For the procedure on how to make this test, see [duty cycle test procedure](#).

1. Connect a TPA-P-DI adapter to the Source DUT HDMI output connector.
2. Configure the Source DUT to output a video format with the required supported pixel clock frequency.
3. Connect a differential probe to the TMDS Clock.
4. Display the waveform of one clock period.
5. Set up the oscilloscope as follows:
 - Adjust the vertical scale to accommodate the waveform in six vertical divisions (Refer vertical setting)
 - Trigger: Edge trigger
 - Acquire at least 10,000 waveforms in FastAcq
6. Find the minimum and maximum duty cycle by using the following method:

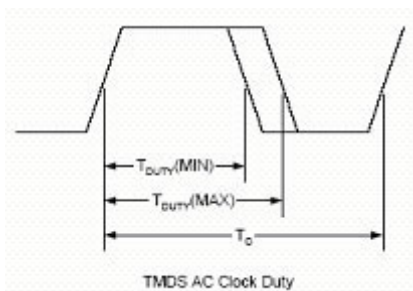

7. Compare with the limit value.
 - If minimum duty cycle is more than 40 percent, then it implies PASS.
 - If maximum duty cycle is less than 60 percent, then it implies PASS.

Rise/Fall Time

This sequence explains the actions that the software takes while it performs a rise/fall time test. For the procedure on how to make this test, see [rise time test procedure](#) and [fall time test procedure](#).

1. Connect an TPA-P-DI adapter to the Source DUT HDMI output connector.
2. Connect the Power Supply to the TPA board.
3. Configure the Source DUT to output a video format with the required supported pixel clock frequency.
4. Connect a differential probe to TMDS_DATA0 and configure as trigger.
5. Set the trigger position at the center of the screen.
6. Set up the oscilloscope as follows:
 - Calculate T_{BIT} by using differential clock.
 - Set the vertical scale to accommodate the waveform in at least six divisions.
 - Set the horizontal scale to more than $2 * T_{BIT}$.
 - If pulse width trigger is selected, Trigger with pulse width trigger with $(4 * T_{BIT})$ pulse or trigger with edge trigger.
7. Accumulate at least 10,000 triggered waveforms by acquiring the waveform in FastAcq mode of acquisition.
8. Calculate V_{SWING} of the signal ($V_{SWING} = V_H - V_L$), and then find the 20 percent and 80 percent of the level.
9. Measure the rise time and fall time.
 - Enable the oscilloscope rise time measurement. Set the reference level to 20 percent and 80 percent.
 - Acquire at least 10 K waveforms (RUN and STOP).
 - Calculate the rise time.
 - Set the trigger to negative pulse.
 - Enable the oscilloscope rise time measurement.
 - Acquire at least 10 K waveforms (RUN and STOP).
 - Calculate the fall time.
10. Compare with the limit.
 - If T_{RISE} is less than 75 ps or T_{RISE} is more than $(0.4 * T_{BIT})$, then it implies FAIL.
 - If T_{FALL} is less than 75 ps or T_{FALL} is more than $(0.4 * T_{BIT})$, then it implies FAIL.
11. Repeat the test for all the remaining TMDS clock and data pairs.

Clock Jitter

This sequence explains the actions that the software takes while it performs a clock jitter test. For the procedure on how to make this test, see [clock jitter test procedure](#).

1. Connect TPA-P-DI to the Source DUT HDMI output connector.
2. Connect the differential probe to the TMDS Clock and configure as trigger.
3. Connect the second differential probe to TMDS_CLOCK.
4. Configure the Source DUT to output the required supported video format.
5. Set up the oscilloscope as follows:
 - Adjust the vertical scale to accommodate the waveform in six vertical divisions
 - Set the record length to 25 M
 - Set the sample rate to ≥ 10 GS/s based on the oscilloscope
 - Trigger with the rising edge of the clock (50 percent level)
6. Capture the waveforms on the oscilloscope.

NOTE. Do not transfer the waveforms.

7. Perform software clock recovery as follows:
 - Set the reference level to 50 percent of the clock and hysteresis to 10 percent of V_{SWING} .
 - Calculate the Software CRU filter as follows.
 $H(s) = 1/(1+s\tau)$, where $\tau = 40$ nsec.
8. Draw the TMDS waveform with positive edge trigger.
9. Measure the clock jitter as follows:
 - Calculate V_{SWING} by using V_{H} and V_{L} of the clock.
 - Calculate the center voltage as follows:
 - $V_{\text{C}} = (V_{\text{H}} + V_{\text{L}})/2$
 - Draw the histogram at $V_{\text{C}} \pm 20$ mV.
 - Calculate Pk-Pk jitter and 'Interpolated' Pk-pk jitter.
10. If clock jitter exceeds $(0.25 * T_{\text{BIT}})$, then it implies FAIL.

Inter-Pair Skew

This sequence explains the actions that the software takes while it performs an inter-pair skew test. For the procedure on how to make this test, see [inter-pair skew test procedure](#).

1. Connect an TPA-P-DI adapter to the Source DUT HDMI output connector.
2. Connect the first differential probe to TMDS_DATA0.
3. Connect the second differential probe to TMDS_DATA1.
4. Configure the Source DUT to output a video format with the required supported pixel clock frequency.
5. Set up the oscilloscope and acquire the waveform.
 - Adjust the vertical scale to accommodate the waveform in six vertical divisions.
 - Calculate T_{BIT} by using differential clock
 - Set the sample rate to ≥ 10 GS/s based on the oscilloscope
 - Set the bit rate based on the T_{BIT} value
 - Acquire the waveform in real-time single shot
6. Calculate the inter-pair skew as follows:
 - Find the CTL pattern in Data<X>
 - Find the CTL pattern in Data<Y>
 - Find the skew between the two channels in each transition
 - Calculate the average skew
7. If T_{SKEW} is greater than $(0.2 * T_{PIXEL})$, then it implies FAIL.
8. Repeat the test for the remaining combinations of TMDS pairs.

Intra-Pair Skew

This sequence explains the actions that the software takes while it performs an intra-pair skew test. For the procedure on how to make this test, see [intra-pair skew test procedure](#).

1. Connect an TPA-P-SE adapter to the Source DUT HDMI output connector.
2. Connect the first single-ended probe to TMDS_DATA0+.
3. Connect the second single-ended probe to TMDS_DATA0-.
4. Configure the Source DUT to output a video format with the highest supported pixel clock frequency.

5. Set up the oscilloscope as follows:
 - Calculate T_{BIT} by using differential clock.
 - Adjust the vertical scale to accommodate the waveform in six vertical divisions.
 - Set the horizontal scale to $(2 * T_{\text{BIT}})$.
 - Trigger with edge trigger of Data+ (Rising edge with 50 percent level).
6. Display the waveform of TMDS_DATA0+ and DATA0-. Accumulate at least 10,000 triggers by acquiring the waveform in FastAcq mode.
7. Determine the most common TMDS_DATA0- 50 percent point by using the histogram method.
8. Measure skew from most common TMDS_DATA0+ point to 50 percent point of first edge of TMDS_DATA0-.
9. If skew is greater than $(0.15 * T_{\text{BIT}})$, then it implies FAIL.
10. Repeat the test for all the remaining TMDS differential pairs.

Min/Max-Diff Swing Tolerance

This sequence explains the actions that the software takes while it performs a min /max-diff swing tolerance test. For the procedure on how to make this test, refer [min/ max-diff swing tolerance test procedure](#).

1. Configure the DTG to output any sink-supported video format.
 - Load the pattern that contains repeating RGB gray ramp 0, 1, 2...254, 255, 0, 1, 2... during each video period.
 - Map all the logical channels to physical channels.
 - Run the DTG.
 - Enable all the output channels.
2. Search for and record the minimum differential swing voltage that the Sink DUT supports without error at $V_{\text{ICM}} = 2.9 \text{ V}$ (Frequency $> 165 \text{ MHz}$) and 3.0 V (Frequency $< 165 \text{ MHz}$).
 - Set $V_{\text{ICM1}} = 3.0 \setminus 2.9 \text{ V}$.
 - Set $V_{\text{DIFF}} = 170 \text{ mV}$ on all TMDS differential pairs. (Note that “Amplitude and Offset” mode in the DTG “Level” window should be chosen. In this mode, “Amplitude” should be set to 0.085 Vpp to correspond to a 170 mV differential swing.)
 - If the test passes at 170 mV , reduce V_{DIFF} in 10 mV steps (corresponding to 0.01 Vpp steps in the “Amplitude” setting) on all pairs until the Sink DUT outputs errors or V_{DIFF} of 90 mV is reached.
 - If the test fails at 170 mV , increase V_{DIFF} in 10 mV steps on all pairs until the Sink DUT outputs pass or V_{DIFF} of 250 mV is reached.
 - Record V_{DIFF} {minimum} at first voltage level where no error appears.
3. Repeat the test for $V_{\text{ICM2}} = 3.3 \text{ V}$.

4. Set $V_{\text{DIFF}} = 1.2 \text{ V}$ on all TMDS differential pairs. (Note that “Amplitude and Offset” mode in the DTG “Level” window should be chosen. In this mode, “Amplitude” should be set to 0.6 Vpp to correspond to a 1.2 V differential swing.)
5. Verify that the DUT continues to support the signal without errors.
6. If DUT fails to support the signal, then it implies FAIL.

Jitter Tolerance

This sequence explains the actions that the software takes while it performs a jitter tolerance test. For the procedure on how to make this test, refer [jitter tolerance test procedure](#).

1. Operate the Sink DUT to support the HDMI input signal.
2. Configure the DTG as follows:
 - Load the appropriate pattern in the DTG
 - No jitter on any output
 - Set the signal outputs to 3.0 V average
3. Configure the AWG as follows:
 - Under “Vertical” menu, set the following:
 - Filter-through
 - Amplitude
 - Offset = 0 V
 - Marker 1 = 0.00 V to 1.00 V
 - Marker 2 = 0.00 V to 2.00 V
 - No jitter on output initially, with ability to add two simultaneous jitter components.
4. Connect the test fixture to the oscilloscope for jitter calibration. The oscilloscope calculates data and clock jitter inserted due to the cables and the test fixtures along with the known amount of jitter.
5. Use the appropriate TTC module based on the recommended resolution.
6. Measure jitter tolerance while verifying adequate support by sink.
 - For each of the two test cases:
 - $D_JITTER = 500 \text{ kHz}$, $C_JITTER = 10 \text{ MHz}$
 - $D_JITTER = 1 \text{ MHz}$, $C_JITTER = 7 \text{ MHz}$
7. Increase the skew (Differential timing offset) in steps of 0.1 Tbit from 0.0 Tbit to 1.0 Tbit. The test fails if the sink outputs errors at any point of time.

Intra-Pair Skew

This sequence explains the actions that the software takes while it performs an intra-pair skew test. For the procedure on how to make this test, refer [intra-pair skew test procedure](#).

1. Configure the DTG to output any sink-supported video format that uses the maximum sink-supported pixel clock frequency. If multiple formats are available, a native format is preferred.
2. Calculate Tbit by using the differential clock.
3. For each of the TMDS clock and data pairs that act as the tested pair:
 - Set the delay for all outputs to 0 nS . Disable “Differential Timing Offset” if it is previously enabled.
 - Move the TMDS “+” signal of the tested pair to DTG output module A, 1+.
 - Move the TMDS “-” signal of the tested pair to DTG output module A, 2+.
 - Change the DTG configuration to output the pattern for the tested TMDS channel on module A, 1.
4. When Skew on all four channels option is selected, the skew on all the four channels will be calculated based on the following conditions:
 - All four modules of the DTG must be DTGM30 modules. The test checks for the modules and throws an error if they are not from the DTGM30.
 - The configuration to run the test are A1-Clock, B1-Data 0, C1- Data 1, and D1- Data 2. If the test fails on any of the channels the skew will be inserted individually on the channels to find the channel that has failed the test.
5. In the DTG “Timing”, set the tested channel (connected to 1A1) and enable “Differential Timing Offset.”
6. Set the delay value in the differential timing offset to approximately $(0.1 * T_{BIT})$. This corresponds to the initial intra-pair skew value.
7. Increase the skew (Differential Timing Offset) by steps of less than or equal to $(0.1 * T_{BIT})$, until the Sink DUT outputs errors or until reaching either $(0.6 * T_{BIT})$ or 1 nsec.
8. If errors are seen on DUT, then:
 - Reduce the skew one step, so that the Sink DUT outputs no errors.
 - If intra-pair skew is less than $(0.4 * T_{BIT})$, then it implies FAIL.

Eye Diagram

This sequence explains the actions that the software takes while it performs an eye diagram test. For the procedure on how to make this test, refer [eye diagram test procedure](#).

Cable Equalizer: The signal degradation of typical passive copper cables increases with the frequency and the length of the cable. To recover data from such cables, TDSHT3 applies the reference cable

equalizer (as specified in the HDMI specification 1.3) automatically to the cable eye diagram measurement when the clock frequency is more than 165 MHz.

1. Configure the DTG to output a video format corresponding to the specified bandwidth of the cable. If no bandwidth is specified, then configure the DTG to output 1920 x 1080i @ 60 Hz (74.25 MHz pixel clock).
 - Load the appropriate pattern file.
 - Set the logical channel to physical channel mapping.
 - Run the pattern.
 - Enable all the DTG output.
2. Configure the DTG to output worst-case eye as follows:
 - Adjust jitter on TMDS_CLOCK pair to output 0.4 nS at 500 KHz (worst jitter permitted at $(TP1 = 0.3 * T_{BIT})$ at 75 MHz).
 - Adjust the output swing voltage to 500 mV for every TMDS single-ended signal.
 - Using jitter/eye analyzer, measure the TMDS_CLOCK jitter and eye diagram of all the three TMDS_DATA pairs.
 - Repeat and readjust as necessary to create the input worst-case eye diagram.
3. Set up the oscilloscope as follows:
 - Set the memory length to at least 25 M points.
 - Set the single-shot trigger at the rising edge of TMDS Clock (50 percent).
 - Set the sample rate to ≥ 10 GS/s based on the oscilloscope.
 - Adjust the vertical scale to accommodate the waveform in six vertical divisions.
4. Perform software clock recovery as follows:
 - Set the reference level to 50 percent of the clock and hysteresis to 10 percent of V_{SWING} .
 - Calculate the Software CRU filter as follows.
$$H(s) = 1/(1+s\tau), \text{ where } \tau = 40 \text{ nsec.}$$
5. Connect the cable DUT between the TPA-R-TDR and TPA-R-DI adapters.
6. Measure jitter at TPA-R-DI (procedure same as the source eye measurement).
 - If data jitter is greater than 0.67 nS ($= 0.5 * T_{BIT}$ at 75 MHz), then it implies FAIL.
 - Calculate the measurement BOX vertical setting as follows:
 - $V_C = (V_H + V_L)/2 = \pm 5 \text{ mV}$
 - Test the eye diagram with sink minimum eye mask. If any of the points violates, then it implies FAIL.
7. Adjust the DTG swing voltage to $(V_H, V_L) = (3.3 \text{ V}, 2.9 \text{ V})$ without jitter (clock jitter should remain at the worst case input condition).

8. Measure the eye mask on all the TMDS_DATA channels at CTP2.
9. If any measured eyes do not meet the sink minimum eye mask, then it implies FAIL.

About HTML/MHT Reports

HTML/MHT Reports enhance the TDSHT3 HDMI Compliance Test Software capabilities by simplifying the process of creating and maintaining results. It automates the process of compiling the test results and generating the reports. The application generates an MHT file that can be opened in Internet Explorer.

Reports Formats

The generated [reports](#) are in .mht format and include the following configured set of information:

- **Configuration:** This section includes the following:
 - **Setup Configuration** such as the oscilloscope information and application version.
 - **Device Configuration** such as Device Details, Resolution, and Refresh Rate.
 - **Compliance Summary** such as the total tests performed and Pass/Fail status.
- **Test Summary:** This section displays the Test Name, Lanes, Specification Range, Measurement Value, and Results.
- **Detailed Results:** This section includes the following:
 - **Results** such as Specification Range, Measurement Value, Tbit, Vswing, Margin, Record length, Mask Hits, and Results.
 - **Waveform/Plot** such as selected plots and/or oscilloscope waveforms.

Sample Report

A sample report is as follows:

HDMI Compliance Test Software: Measurement Report

Wed Apr 30 15:29:45 IST 2008

Cable Tests Report

• **Configuration**

▸ **Setup Configuration**

Oscilloscope Info DPO72004 - 4.1.1 Build 6
 TDSHT3v1.3 Version 4.0.0 Build 10

▸ **Device Configuration**

Device Details HDMI Device
 Resolution 1920*1080i
 Refresh Rate 60Hz

▸ **Compliance Summary**

Total Tests (for all data lanes) 4
 Tests Completed 4
 Pass 3
 Fail 1

• **Test Summary**

Index	Test Name	Lanes	Spec Range	Meas Value	Result
1	5-3 : Cable Eye Diagram TP1	CK - D0	TP1 Data Jitter < 0.3*Tbit;	0.3*Tbit	Fail
2	5-3 : Cable Eye Diagram TP2	CK - D0	TP2 Data Jitter < 0.5*Tbit;	0.29*Tbit	Pass
3	5-3 : Cable Eye Diagram TP2	CK - D1	TP2 Data Jitter < 0.5*Tbit;	0.28*Tbit	Pass
4	5-3 : Cable Eye Diagram TP2	CK - D2	TP2 Data Jitter < 0.5*Tbit;	0.29*Tbit	Pass

• **Detailed Results**

▸ **5-3 : Cable Eye Diagram TP1 : CK - D0**

▸ **Results**

Spec Range	Meas Value	Tbit	Vs	Margin	Record Length	Mask Hits	Result
TP1 Data Jitter < 0.3*Tbit;	0.3*Tbit	673.40ps	957.60mV	0.0*Tbit	25.000M	17	Fail

▸ **Waveform/Plot**

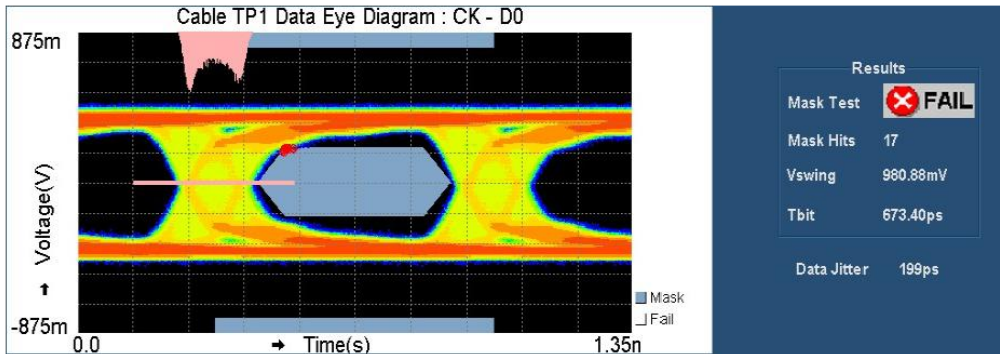

▸ [Return to Test Summary](#)

▶ 5-3 : Cable Eye Diagram TP2 : CK - D0

▶ Results

Spec Range	Meas Value	Tbit	Vs	Margin	Record Length	Mask Hits	Result
TP2 Data Jitter < 0.5*Tbit;	0.29*Tbit	673.40ps	980.88mV	0.21*Tbit	25.000M	0	Pass

▶ Waveform/Plot

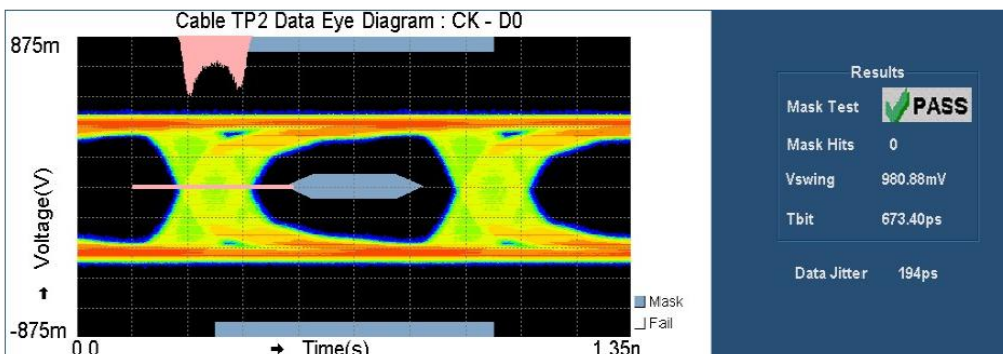

▶ Return to Test Summary

▶ 5-3 : Cable Eye Diagram TP2 : CK - D1

▶ Results

Spec Range	Meas Value	Tbit	Vs	Margin	Record Length	Mask Hits	Result
TP2 Data Jitter < 0.5*Tbit;	0.28*Tbit	673.40ps	745.04mV	0.22*Tbit	25.000M	0	Pass

▶ Waveform/Plot

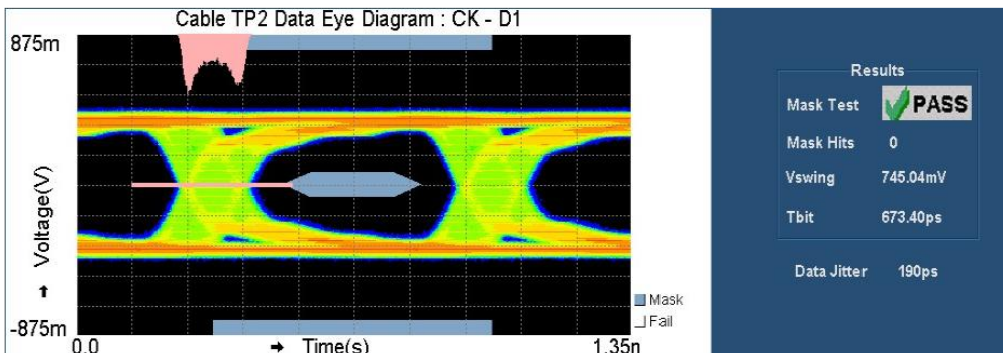

▶ Return to Test Summary

▶ 5-3 : Cable Eye Diagram TP2 : CK - D2

▶ Results

Spec Range	Meas Value	Tbit	Vs	Margin	Record Length	Mask Hits	Result
TP2 Data Jitter < 0.5*Tbit;	0.29*Tbit	673.40ps	750.12mV	0.21*Tbit	25.000M	0	Pass

▶ Waveform/Plot

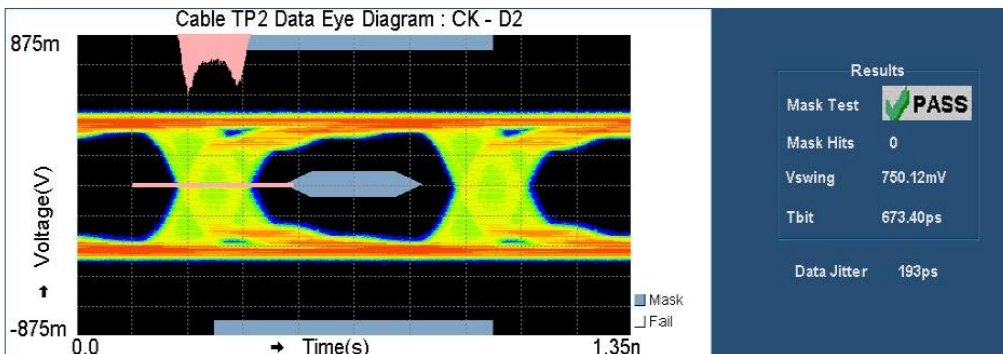

▶ Return to Test Summary

▶ Return to top

Index

Symbols and Numbers

4-Channel feature, 9

A

Acquisition Alert Message, 29
Auto Increment, 153
Automation Explorer, 34

C

Cable, 34
 Differential Tests, 1
Clear Report, 160
Clock Jitter, 56
Close, 154
Configure, 30
 Cable, 61
 DTG pattern list, 55
 Sink, 60
 Source, 58
Connect
 Cable
 Eye Diagram, 125
 Jitter Tolerance, 111
 Min/Max-Diff Swing
 Tolerance, 106
 Sink
 Intra-Pair Skew, 121
 Source, 62
Connect Cable
 Eye Diagram
 4-Channel, 128
 4-Channel with AFG jitter
 insertion, 129

Connect Source
 Differential Tests
 4-Channel, 87
 Eye Diagram
 4-Channel, 65
 Fall Time
 4-Channel, 74
 Inter-Pair Skew
 4-Channel, 83
 Intra-Pair Skew
 4-Channel, 93
 Low Amplitude –
 4-Channel, 105
 Low Amplitude +
 4-Channel, 99
 Rise Time
 4-Channel, 71
Connectivity, 6
CRU, 7

D

Data Lane, 152
Deskew, 8
Device Details, 152
Differential Tests Select All, 188
DTG, 211
Duty Cycle, 51

E

Error codes, 15
 Configure, 15
 Deskew, 15
 DTG, 15
 GPIO, 15
 Hysteresis, 15
 Mask Movement, 15
 Option ST, 15
 Signal Sources, 15
 Tbit, 15
 View Waveform, 15
Error Message, 15
Ethernet, 40
 GPIO-ENET/100, 40

Execution pane, 33
Existing Tbit, 88
Exit, 12
External, 54
Eye Diagram, 58
 select, 56

F

Fail, 216
Fall Time, 51
 View Waveform, 137
Features, 2
Field, 23
File menu, 216
File Names, 13
Find, 249
Fine button, 34

G

General Purpose Knob, 34
GPIO, 229

H

HDMI, 182
Help, 28
High Definition Multimedia
 Interface, 1
How to Use Online Help, 3
HTML/MHT Reports, 255
Hysteresis, 144

I

Input, 239
Install, 34
 Measurement, 34
Install NI-488.2, 34
 Windows, 34
Instruments, 34
 Scan, 34
Inter-Pair Skew, 51
 Differential Tests, 51

Interfaces, 40
 GPIB, 34
Interfaces list, 40
Internal, 54
Intra-Pair Skew, 57
Invalid Signal, 6

J

Jitter Tolerance, 34

L

Low Amplitude, 56
 select, 206
Low Pass Filter, 239
Lower Margin, 166

M

Max, 154
Mean, 154
Meas Value, 229
Menu bar, 23
Min, 154
Min/Max-Diff Swing
 Tolerance, 57

N

National Instruments, 40
NI-488.2, 40
NI-VISA, 34

O

Ordering fixtures, 6
Over/Undershoot V-H, 56
Over/Undershoot V-L, 51

P

Pair, 188
Pass, 196
Pattern Path, 223
Phase Detector, 239
Phase Locked Loop, 239
Pinging, 40

Pk-Pk, 154
Plug, 40
Population, 188
Position Eye Mask, 29
Preferences, 29
Primary Address, 34
Probe Control, 29
Properties, 40
Pulse Width, 29

Q

Query, 34
Query Form, 46
Quit, 12
 Software, 12

R

Raw, 188
Re-calculate, 155
Rec Length, 173
Recall, 25
Recommended Accessories, 5
Record Length, 188
Ref Level Units, 216
Refresh Rate, 155
Remarks/Comments, 211
Remote GPIB Commands, 46
Report Configuration, 216
Report File, 31
Report Generator, 27
Report Viewer, 33
Reports
 formats, 255
Requirements, 6
Resolution, 206
Restore Application, 9
Result, 153
Result Details, 160
Result pane, 31
Result Statistics, 160
Result Summary, 7
Results menu, 26
Return, 12
Rise Time, 160

Rise/Fall Time, 25

S

Sample Report, 256
Save As, 153
Save/Recall, 46
Scroll bar, 23
Secondary Address, 34
Select All, 188
Select Pulse Width, 29
Selection pane, 30
Shortcut Keys
 set probe control to
 internal, 13
Signal Sources, 229
Sink, 211
 Differential Tests, 1
 Single-Ended Tests, 1
Sink Configuration, 7
Software CRU Technology, 239
Software Folders, 13
Source, 155
 Differential Tests, 1
 Single-Ended Tests, 1
Source Configuration, 7
Source DUT, 249
Source Test, 7
Spec Range, 47
Status, 152
Status bar, 33
Std Dev, 188
Supported Oscilloscopes, 5
Supported Probes, 5
Supported Test Fixtures, 5

T

Tbit, 249
 Calculate, 252
 Duty Cycle, 51
 existing, 155
TekVisa, 6

- Test
 - Cable Eye Diagram, 229
 - Clock Jitter, 173
 - Differential Tests Select
 - All, 188
 - Duty Cycle, 155
 - Fall Time, 166
 - Inter-Pair Skew, 182
 - Jitter Tolerance, 216
 - Low Amplitude –, 206
 - Low Amplitude +, 201
 - Min/Max-Diff Swing
 - Tolerance, 211
 - Rise Time, 160
 - Sink Intra-Pair Skew, 223
 - Source Eye Diagram, 144
 - Source Intra-Pair Skew, 196
 - Test Conn, 211
 - Test Methods
 - Cable Eye Diagram, 252
 - Clock Jitter, 248
 - Duty Cycle, 246
 - Inter-Pair Skew, 249
 - Jitter Tolerance, 251
 - Min/Max-Diff Swing
 - Tolerance, 250
 - Rise/Fall Time, 247
 - Sink Intra-Pair Skew, 252
 - Source Eye Diagram, 245
 - Source Intra-Pair Skew, 249
 - Test Name, 152
 - Test Point, 229
 - Tests menu, 26
- U**
- Utilities menu, 27
- V**
- View Eye Plot, 7
 - View Jitter Plot, 31
 - View Waveform, 30
 - Cable
 - Eye Diagram, 144
 - Clock Jitter, 138
 - Differential Tests Select
 - All, 140
 - Duty Cycle, 135
 - Eye Diagram, 134
 - Inter-Pair Skew, 139
 - Jitter Tolerance, 143
 - Low Amplitude –, 143
 - Low Amplitude +, 142
 - Min/Max-Diff Swing
 - Tolerance, 143
 - Rise Time, 136
 - Sink
 - Intra-Pair Skew, 144
 - Source
 - Intra-Pair Skew, 141
 - Virtual Keyboard, 48