

Agilent AN 1287-3

Applying Error Correction to Network Analyzer Measurements

Application Note

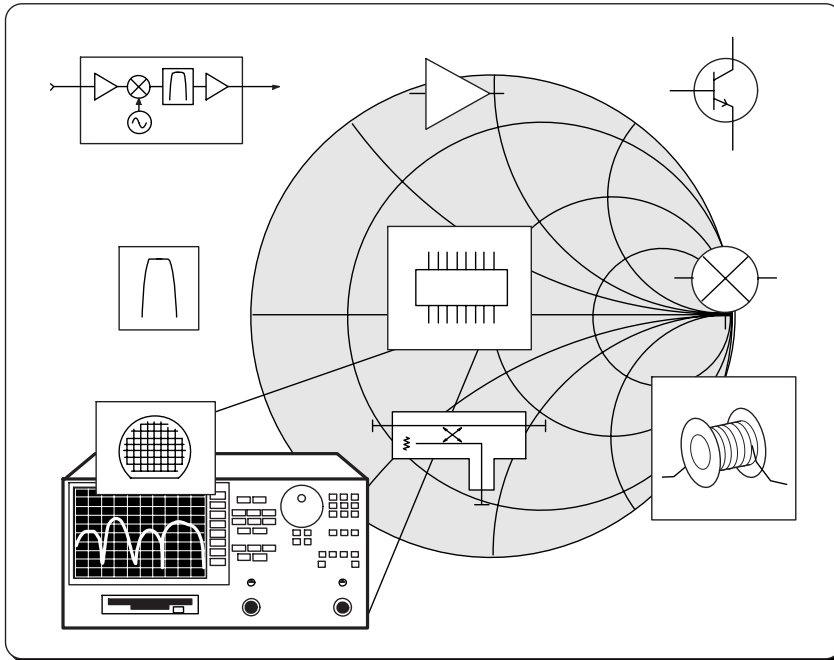

Table of Contents

2	Introduction
3	Sources and Types of Errors
4	Types of Error Correction
4	One-Port Calibration
5	The Effects of Adapters
6	Two-Port Error Correction
7	Electronic Calibration
8	Estimating Measurement Uncertainty
10	Performing a Transmission Response Calibration
11	Enhanced-Response Calibration for Transmission Measurements
12	Full Two-Port Calibration
12	TRL Calibration
13	Calibrating Noninsertable Devices
13	Swap-Equal-Adapters Method
14	Adapter-Removal Calibration



Agilent Technologies

Innovating the HP Way

Introduction

Only perfect test equipment would not need correction. Imperfections exist in even the finest test equipment and cause less than ideal measurement results. Some of the factors that contribute to measurement errors are repeatable and predictable over time and temperature and can be removed, while others are random and cannot be removed. The basis of network analyzer error correction is the measurement of known electrical standards, such as a through, open circuit, short circuit, and precision load impedance.

The effect of error correction on displayed data can be dramatic (Figure 1). Without error correction, measurements on a bandpass filter show considerable loss and ripple. The smoother, error-corrected trace produced by a two-port calibration subtracts the effects of systematic errors and better represents the actual performance of the device under test (DUT).

This application note describes several types of calibration procedures, including the popular Short-Open-Load-Through (SOLT) calibration technique, and Through-Reflect-Line (TRL). The effectiveness of these procedures will then be demonstrated in the measurement of high-frequency components such as filters. Calibrations will also be shown for those cases requiring coaxial adapters to connect the test equipment, DUT, and calibration standards.

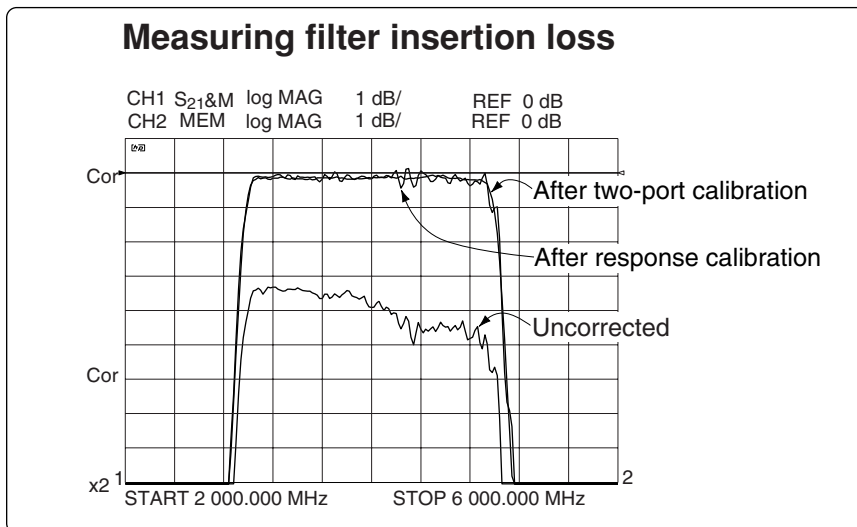

Figure 1. Response versus Two-Port Calibration

Sources and Types of Errors

All measurement systems, including those employing network analyzers, can be plagued by three types of measurement errors:

- Systematic errors
- Random errors
- Drift errors

Systematic errors (Figure 2) are caused by imperfections in the test equipment and test setup. If these errors do not vary over time, they can be characterized through calibration and mathematically removed during the measurement process. Systematic errors encountered in network measurements are related to signal leakage, signal reflections, and frequency response. There are six types of systematic errors:

- Directivity and crosstalk errors relating to signal leakage
- Source and load impedance mismatches relating to reflections
- Frequency response errors caused by reflection and transmission tracking within the test receivers

(The full two-port error model includes all six of these terms for the forward direction and the same six (with different data) in the reverse direction, for a total of twelve error terms. This is why two-port calibration is often referred to as twelve-term error correction.)

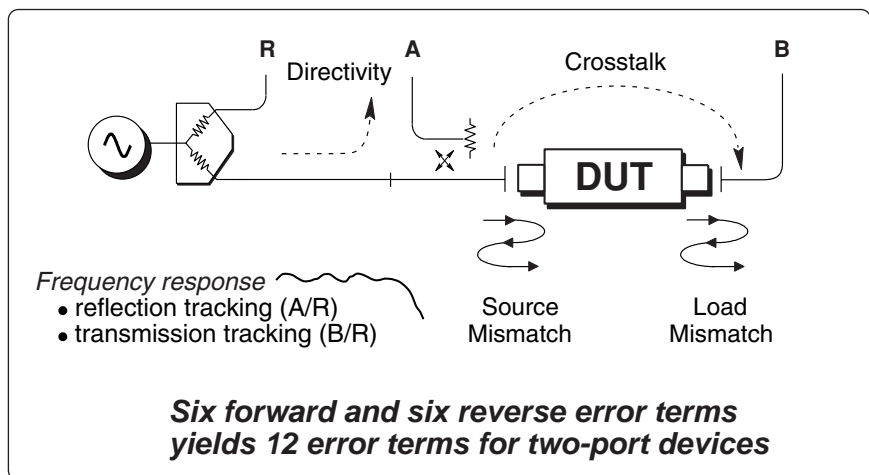

Figure 2. Systematic Measurement Errors

Random errors vary randomly as a function of time. Since they are not predictable, they cannot be removed by calibration. The main contributors to random errors are instrument noise (e.g., sampler noise, and the IF noise floor), switch repeatability, and connector repeatability. When using network analyzers, noise errors can often be reduced by increasing source power, narrowing the IF bandwidth, or by using trace averaging over multiple sweeps.

Drift errors occur when a test system's performance changes after a calibration has been performed. They are primarily caused by temperature variation and can be removed by additional calibration. The rate of drift determines how frequently additional calibrations are needed. However, by constructing a test environment with stable ambient temperature, drift errors can usually be minimized. While test equipment may be specified to operate over a temperature range of 0 °C to +55 °C, a more controlled temperature range such as +25 °C \pm 5 °C can improve measurement accuracy (and reduce or eliminate the need for periodic recalibration) by minimizing drift errors.

Types of Error Correction

There are two basic types of error correction—response (normalization) corrections, and vector corrections.

Response calibration is simple to perform, but corrects for only a few of the 12 possible systematic error terms (namely, reflection and transmission tracking). Response calibration is a normalized measurement in which a reference trace is stored in the network analyzer's memory, and the stored trace is divided into measurement data for normalization. A more advanced form of response calibration for reflection measurements, called open/short averaging, is commonly found on scalar analyzers and averages two traces to derive a reference trace.

Vector error correction is a more thorough method of removing systematic errors. This type of error correction requires a network analyzer capable of measuring (but not necessarily displaying) phase as well as magnitude, and a set of calibration standards with known, precise electrical characteristics.

The vector-correction process characterizes systematic error terms by measuring known calibration standards, storing these measurements within the analyzer's memory, and using this data to calculate an error model which is then used to remove the effects of systematic errors from subsequent measurements. This calibration process accounts for all major sources of systematic errors and permits very accurate measurements. However, it requires more standards and more measurements than response calibration. The two main types of vector error correction are the one-port and two-port calibrations.

One-Port Calibration

A one-port calibration can measure and remove three systematic error terms (directivity, source match, and reflection tracking) from reflection measurements. These three error terms are derived from a general equation which can be solved in terms of three simultaneous equations with three unknowns. To establish these equations, three known calibration standards must be measured, such as an open, a short, and a load (the load value is usually the same as the characteristic impedance of the test system, generally either 50 or 75 ohm). Solving the equations yields the systematic error terms and makes it possible to derive the DUT's actual reflection S-parameters.

When measuring two-port devices, a one-port calibration assumes a good termination on the unused port of the DUT. If this condition is met (by connecting a load standard, for example), the one-port calibration is quite accurate. However, if port two of the DUT is connected to the network analyzer and its reverse isolation is low (for example, filter passbands or low-loss cables), the assumption of a good load termination is often not valid. In this case, two-port error correction can provide significantly better results than one-port correction. An amplifier is a good example of a two-port device in which the load match presented by the network analyzer does not affect measurements of the amplifier's input match, because the reverse isolation of the amplifier allows one-port calibration to be effective.

In Figure 3, a reflection measurement is shown with and without a one-port calibration. Without error correction, the classic ripple pattern appears, which is caused by systematic errors interfering with the test signal. The error-corrected trace is much smoother and better represents the device's actual reflection performance.

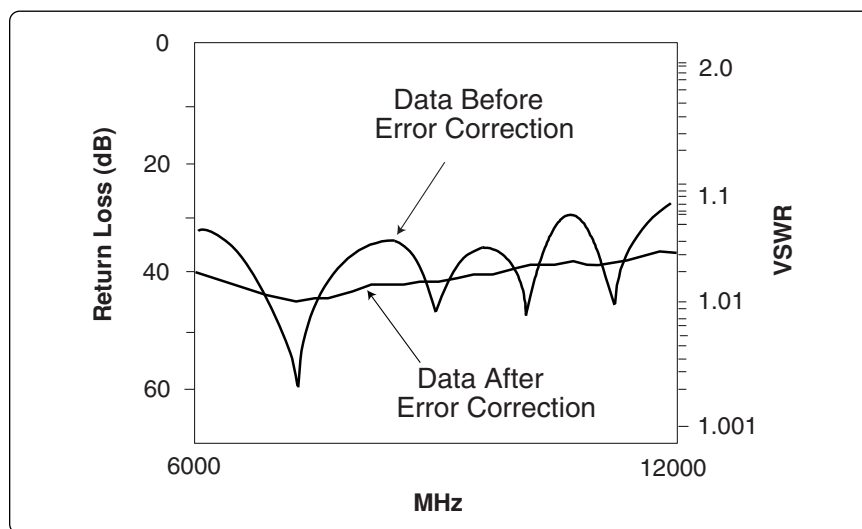

Figure 3. Before and After One-Port Calibration

The Effects of Adapters

Ideally, reflection calibrations should be performed with a calibration kit having the same type connectors as the DUT. If adapters are necessary to make connections, the effects of these adapters must then be considered as part of the measurement uncertainty.

An adapter added to a network analyzer test port after a calibration has been done may cause errors that add to or subtract from the desired signal from the DUT (Figure 4). This error is often ignored, which may not be acceptable. Worst-case effective directivity in this case is the sum of the corrected directivity and the reflection (r) of the adapter. An adapter with a VSWR of 1.5:1 for example, will reduce the effective directivity of a test coupler to about 14 dB, even if the coupler itself has infinite directivity. So with an “ideal” load on the output of the adapter, the reflected signal appearing at the coupled port will be only 14 dB less than the reflection from a short or open circuit.

Stacking multiple adapters compounds the problem. If adapters cannot be avoided, the highest-quality types are always the best choice in order to reduce degradation of system directivity. Error correction can mitigate the effects of adapters on the test port, but the test system will be slightly more susceptible to drift because of degraded raw (uncorrected) directivity.

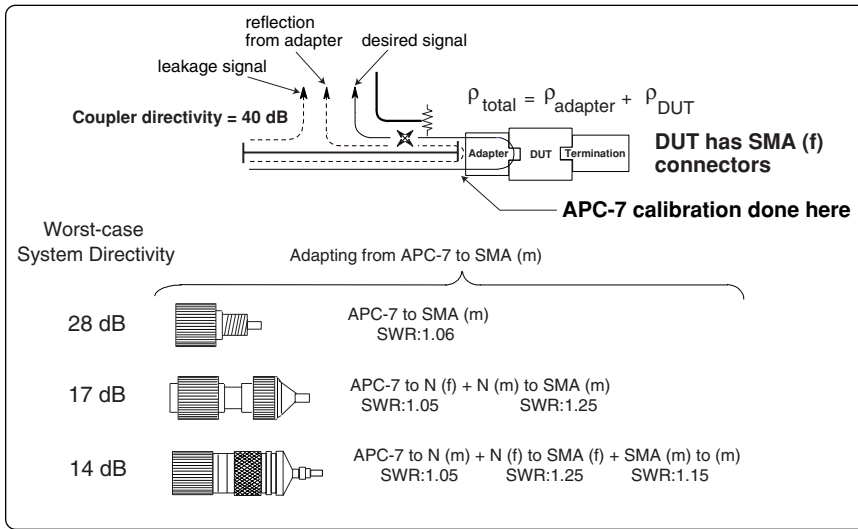

Figure 4. Adapter Considerations

Two-Port Error Correction

Two-port error correction yields the most accurate results because it accounts for all of the major sources of systematic error. The error model for a two-port device reveals the four S-parameters measured in the forward and reverse directions (Figure 5).

Once the system error terms have been characterized, the network analyzer utilizes four equations to derive the actual device S-parameters from the measured S-parameters. Because each S-parameter is a function of all four measured S-parameters, a network analyzer must make a forward and reverse test sweep before updating any one S-parameter.

When performing a two-port calibration, the part of the calibration that characterizes crosstalk (isolation) can often be omitted. Crosstalk, which is signal leakage between test ports when no device is present, can be a problem when testing high-isolation devices such as a switch in the open position, and high-dynamic-range devices such as filters with a high level of rejection.

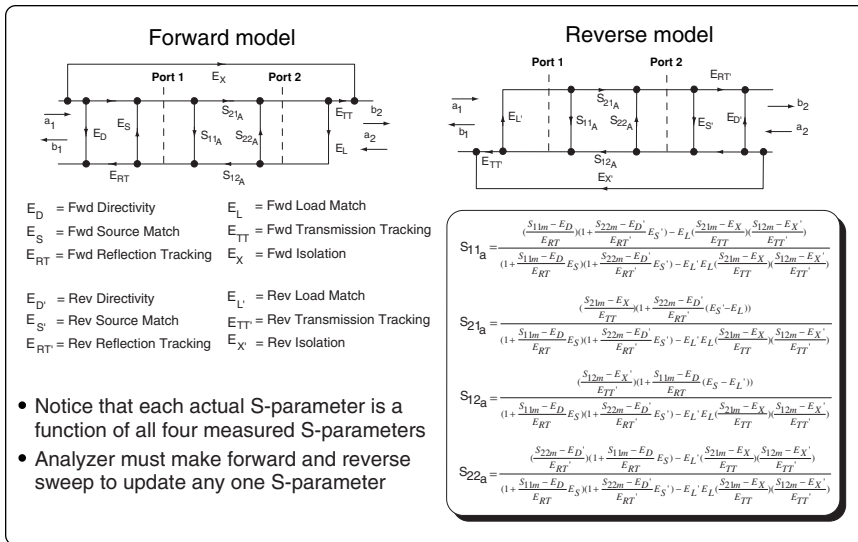

Figure 5. Two-Port Error Correction

Unfortunately, a crosstalk calibration can add noise to the error model because measurements are often made near the analyzer's noise floor. If the isolation calibration is deemed necessary, it should be performed with trace averaging to ensure that the test system's crosstalk is not obscured by noise. In some network analyzers, crosstalk can be minimized by using the alternate sweep mode instead of the chop mode (the chop mode makes measurements on both the reflection (A) and transmission (B) channels at each frequency point, whereas the alternate mode turns off the reflection receiver during the transmission measurement).

The best way to perform an isolation calibration is by placing the devices that will be measured on each test port of the network analyzer, with terminations on the other two device ports. Using this technique, the network analyzer sees the same impedance versus frequency during the isolation calibration as it will during subsequent measurements of the DUT. If this method is impractical (in test fixtures, or if only one DUT is available, for example), then placing a terminated DUT on the source port and a termination on the load port of the network analyzer is the next best alternative (the DUT and termination must be swapped for the reverse measurement). If no DUT is available or if the DUT will be tuned (which will change its port matches), then terminations should be placed on each network analyzer test port for the isolation calibration.

A network analyzer can be used for uncorrected measurements, or with any one of a number of calibration options, including response calibrations and one- or two-port vector calibrations. A summary of these calibrations is shown in Figure 6).

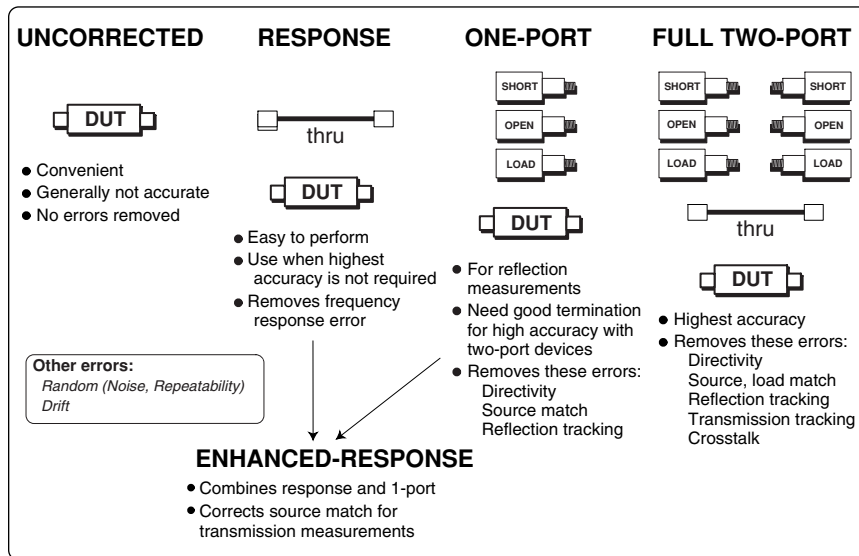

Figure 6. Errors and Calibration Standards

Electronic Calibration

Although Figure 6 shows mechanical calibration standards, Agilent Technologies offers a solid-state calibration solution which makes two-port calibration fast, easy, and less prone to operator errors. The various impedance states in the calibration modules are switched with PIN-diode or FET switches, so the calibration standards never wear out.

The calibration modules are characterized at the Agilent factory using a TRL-calibrated network analyzer, making the ECal modules transfer standards (rather than direct standards). ECal provides excellent accuracy, with results generally better than SOLT calibration, but somewhat less than a properly-performed TRL calibration.

Estimating Measurement Uncertainty

Figure 7 shows which systematic error terms are accounted for when using analyzers with transmission/reflection test sets (Agilent 8712ET family, the 8753ET and the 8720ET family), and S-parameter test sets (Agilent 8753ES, 8720ES, Agilent 8510 family and the PNA Series). Some straightforward techniques can be used to determine measurement uncertainty when evaluating two-port devices with a network analyzer based on a transmission/reflection test set. For example, Figure 8 shows measurement of the input match of a filter after a one-port calibration has been performed. The filter has 16 dB of return loss and 1 dB of insertion loss. The raw load match of an 8712ET network analyzer is specified to be 18 dB (although it's often significantly better than this). The reflection from the test port connected to the filter's output port is attenuated by twice the filter loss—in this case, only 2 dB. This value is not adequate to sufficiently suppress the effects of this error signal, which illustrates why low-loss devices are difficult to measure accurately.

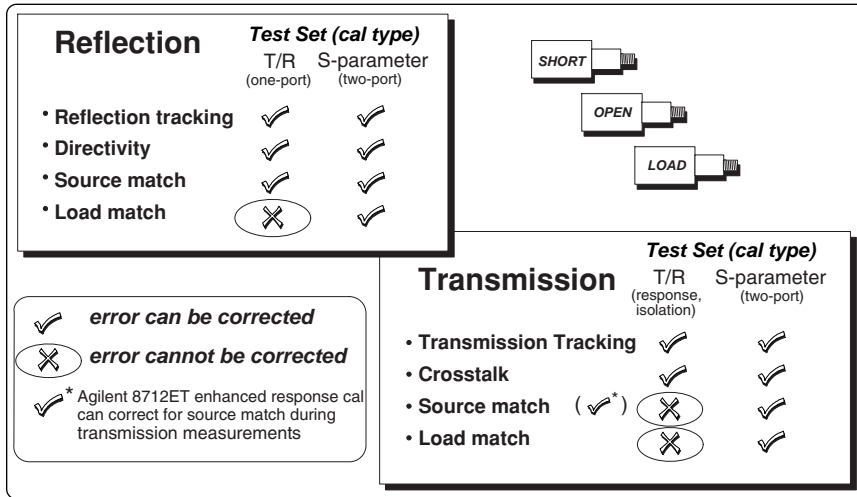

Figure 7. Calibration Summary

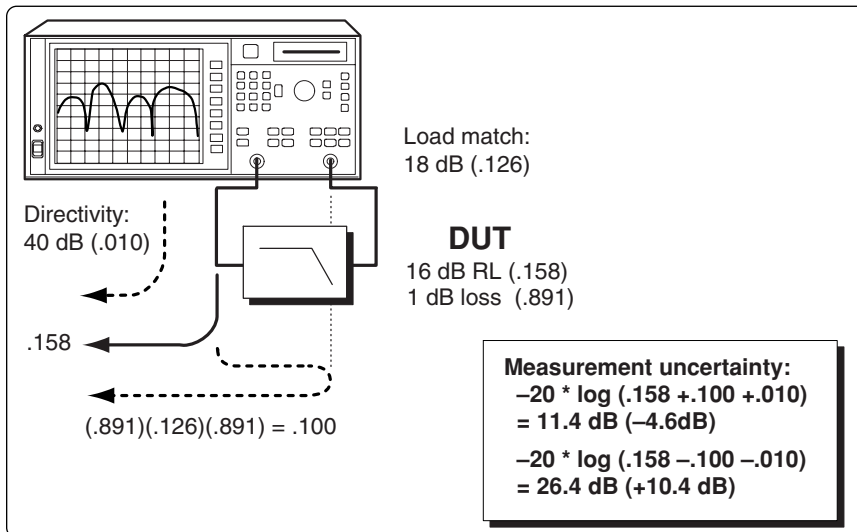

Figure 8. Reflection Example Using a One-Port Cal

To determine the measurement uncertainty of this example, it is necessary to add and subtract the undesired reflection signal (with a reflection coefficient of 0.100) with the signal reflecting from the DUT (0.158) (to be consistent with the next example, we will also include the effect of the directivity error signal). The measured return loss of the 16-dB filter may appear to be anywhere from 11.4 dB to 26.4 dB, allowing too much room for error. In production testing, these errors could easily cause filters which met specification to fail, while filters that actually did not meet specification might pass. In tuning applications, filters could be mistuned as operators try to compensate for the measurement error.

When measuring an amplifier with good isolation between output and input (i.e., where the isolation is much greater than the gain), there is much less measurement uncertainty. This is because the reflection caused by the load match is severely attenuated by the product of the amplifier's isolation and gain. To improve measurement uncertainty for a filter, the output of the filter must be disconnected from the analyzer and terminated with a high-quality load, or a high-quality attenuator can be inserted between the filter and port 2 of the analyzer. Both techniques improve the analyzer's effective load match. As an example (Figure 9), if we placed a 10 dB attenuator with a SWR of 1.05 between port 2 of the network analyzer and the filter used in the previous example, our effective load match would improve to 28.6 dB. This value is the combination of a 32.3 dB match from the attenuator and a 38 dB match from the network analyzer (since the error signal travels through the attenuator twice, the analyzer's load match is improved by twice the value of the attenuator). Our worst-case uncertainty is now reduced to +2.5 dB, -1.9 dB, instead of the +10.4 dB, -4.6 dB we had without the 10 dB attenuator. While not as good as what could be achieved with two-port calibration, this level of accuracy may be sufficient for manufacturing applications.

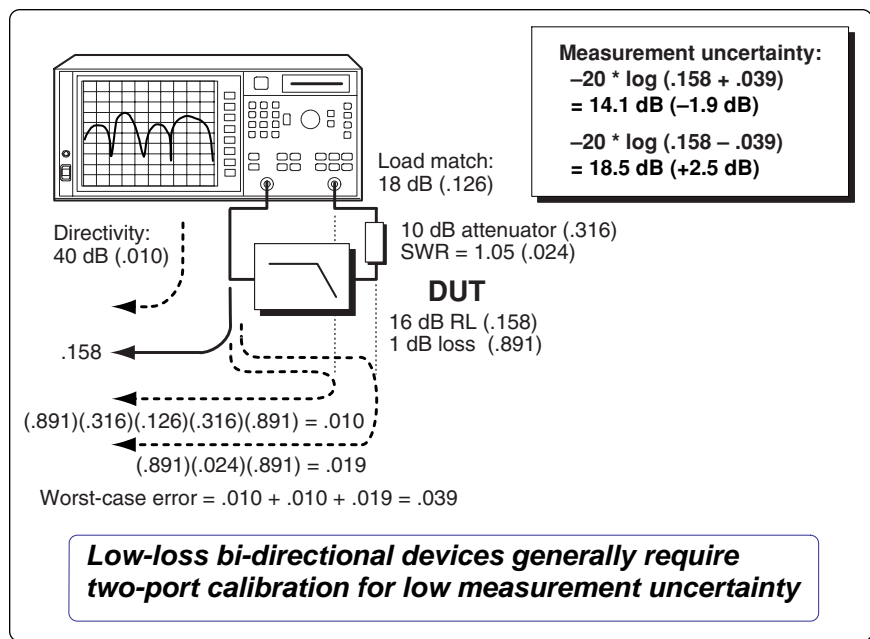

Figure 9. Reflection Example using a One-port Cal plus an Attenuator

Performing a Transmission Response Calibration

Response calibrations offer simplicity, but with some compromise in accuracy. In making a filter transmission measurement using only response calibration, the first step is to make a through connection between the two test ports (with no DUT in place). For this example, test port specifications for the Agilent 8712ET network analyzer will be used. The ripple caused by this amount of mismatch is calculated as ± 0.22 dB, and is now present in the reference data (Figure 10). It must be added to the uncertainty when the DUT is measured in order to compute worst-case overall measurement uncertainty.

The same setup and test port specifications for the 8712ET can be used to determine the measurement uncertainty with the DUT in place. There are three main error signals caused by reflections between the ports of the analyzer and the DUT (Figure 11). Higher-order reflections can be neglected because they are small compared to the three main terms.

One of the error signals passes through the DUT twice, so it is attenuated by twice the insertion loss of the DUT. A worst-case condition occurs when all of the reflected error signals add together in phase ($0.020 + 0.020 + 0.032 = 0.072$). In that case, measurement uncertainty is $+0.60/-0.65$ dB. Total measurement uncertainty, which must include the 0.22 dB of error incorporated into the calibration measurement, is about ± 0.85 dB.

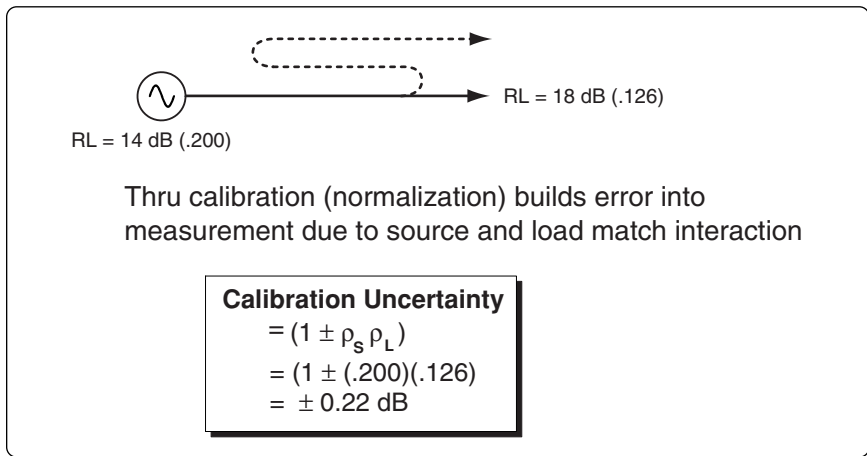

Figure 10. Transmission Example Using a Response Cal

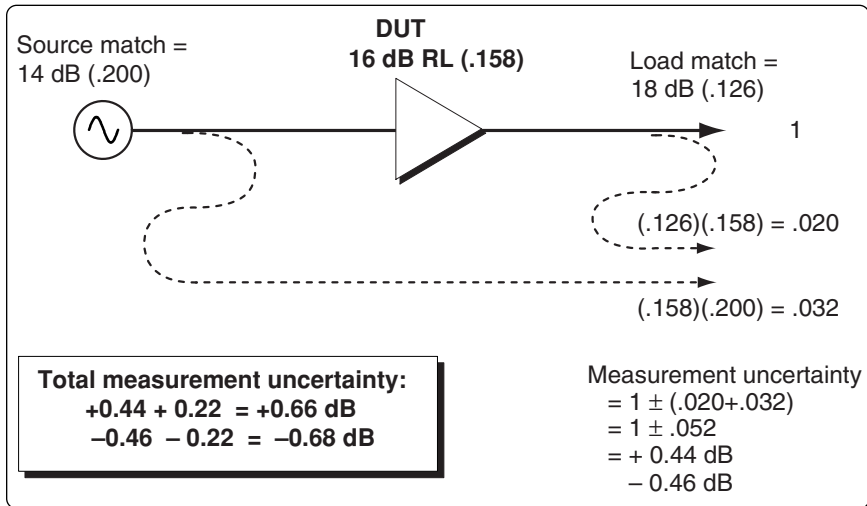

Figure 11. Transmission Example (continued)

Another test example is an amplifier with a port match of 16 dB. The test setup and conditions remain essentially the same as in the first two cases (Figure 12), except now the middle error term is no longer present because of the amplifier's reverse isolation. This reduces the measurement error to about ± 0.45 dB and the total measurement uncertainty to about ± 0.67 dB (compared to ± 0.85 dB for the filter).

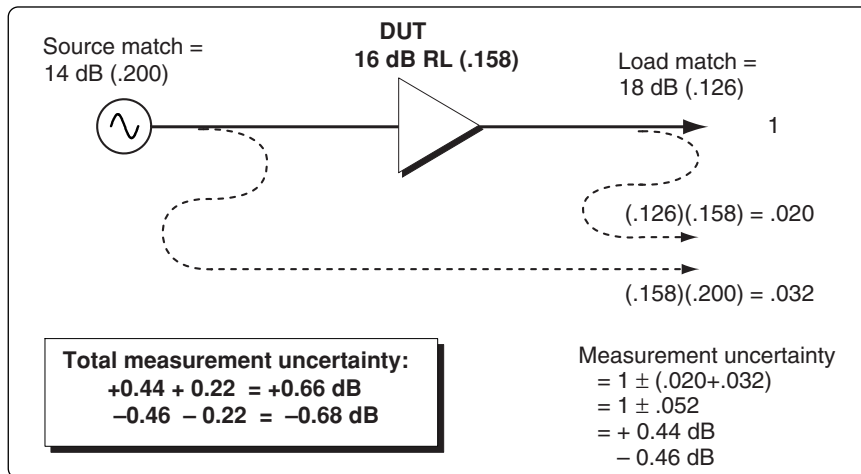

Figure 12. Measuring Amplifiers with a Response Calibration

Enhanced-Response Calibration for Transmission Measurements

A feature of the 8712ET/ES family of economy network analyzers is their ability to perform an enhanced-response calibration. This calibration requires the measurement of short, open, load, and through standards for transmission measurements. The enhanced-response calibration combines a one-port calibration and a response calibration to allow correction of source match during transmission measurements, something a standard response calibration cannot do.

The enhanced-response calibration (Figure 13) improves the effective source match during transmission measurements to about 35 dB, compared to 14 dB for normal response calibrations with the 8712ET. This reduces the calibration error from ± 0.22 dB to ± 0.02 dB, and greatly reduces the two measurement error terms that involve interaction with the effective source match. The total measurement error is ± 0.24 dB instead of the previous value of ± 0.85 dB for a standard response calibration. While not as good as full two-port error correction, this represents a significant improvement over a standard response calibration and may be sufficient for many applications.

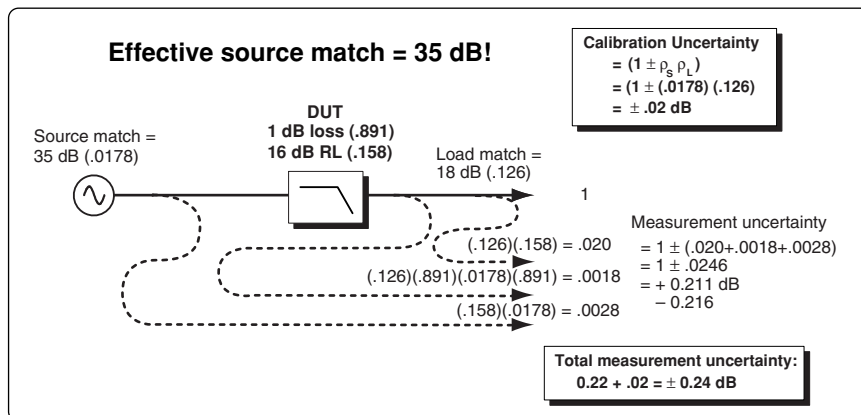

Figure 13. Transmission Measurements using the Enhanced-Response Calibration

Full Two-Port Calibration

In an example that calculates the measurement error after a two-port calibration (Figure 14), the worst-case measurement errors for the filter have been reduced to about ± 0.5 dB for reflection measurements and ± 0.05 dB for transmission measurements. Phase errors are similarly small.

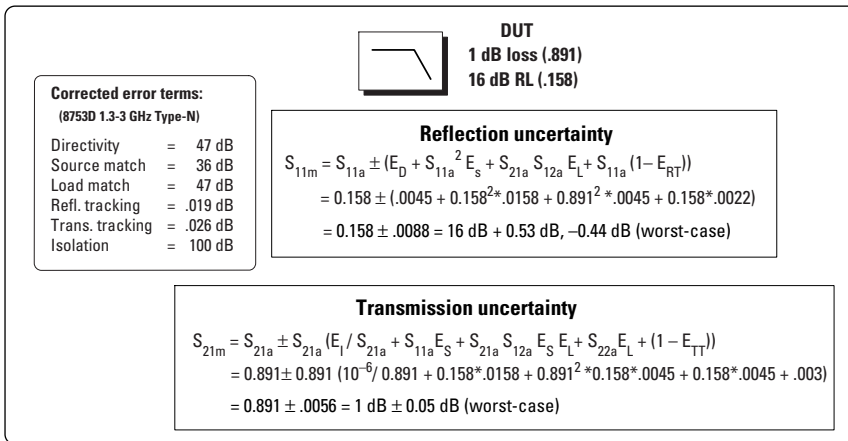

Figure 14. Calculating Measurement Uncertainty after a Two-Port Calibration

TRL Calibration

Following SOLT in popularity, the next most common form of two-port calibration is called a Through-Reflect-Line (TRL) calibration. It is primarily used in noncoaxial environments, such as testing waveguide, using test fixtures, or making on-wafer measurements with probes. TRL uses the same 12-term error model as a SOLT calibration, although with different calibration standards.

TRL has two variants:

- True TRL calibration, which requires a network analyzer with four receivers
- TRL* calibration, developed for network analyzers with only three receivers

Other variations of TRL are based on Line-Reflect-Match (LRM) calibration standards or Through-Reflect-Match (TRM) calibration standards.

In differentiating TRL and TRL*, the latter assumes that the source and load match of a test port are equal—that there is true port-impedance symmetry between forward and reverse measurements. This is only a fair assumption for a three-receiver network analyzer. TRL* requires 10 measurements to quantify 8 unknowns.

True TRL requires four receivers (two reference receivers plus one each for reflection and transmission) and 14 measurements to solve for 10 unknowns. Both techniques use identical calibration standards. The Agilent 8720ES network analyzer, which is normally equipped with only three samplers, can perform TRL calibrations when outfitted with Option 400 (which adds a fourth sampler).

In noncoaxial applications, TRL achieves better source match and load match corrections than TRL*, resulting in less measurement error. In coaxial applications, SOLT is usually the preferred calibration technique. While not commonly used, coaxial TRL can provide more accuracy than SOLT, but only if very-high quality coaxial transmission lines (such as beadless airlines) are used.

Calibrating Noninsertable Devices

When performing a through calibration, normally the test ports mate directly. For example, two cables with the appropriate connectors can be joined without a through adapter, resulting in a zero-length through path. An insertable device may be substituted for a zero-length through. This device has the same connector type on each port but of the opposite sex, or the same sexless connector on each port, either of which makes connection to the test ports quite simple.

A noninsertable device is one that can not be substituted for a zero-length through. It has the same type and sex connectors on each port or a different type of connector on each port, such as waveguide at one end and a coaxial connector on the other end.

There are a few calibration choices available for noninsertable devices. The first is to use a characterized through adapter (electrical length and loss specified), which requires modifying the calibration kit definition. This will reduce (but not eliminate) source and load match errors. A high-quality through adapter (with good match) should be used since the match of the adapter cannot be characterized.

Swap-Equal-Adapters Method

The swap-equal-adapters method requires the use of two precision matched adapters that are equal in performance but have connectors of different sexes. To be equal, the adapters must have the same match, characteristic impedance, insertion loss, and electrical delay. Many of Agilent's calibration kits include matched adapters.

The first step in the swap-equal-adapters method is to perform a transmission calibration with the first adapter (Figure 15). Following this, the first adapter is removed and the second adapter is placed on port 2. This second adapter then becomes the effective test port. The reflection calibration is then performed on both test ports. Following this, the DUT is measured with the second adapter in place. The errors remaining after calibration are equal to the difference between the two adapters. The technique provides a high level of accuracy, but not quite as high as the more complicated adapter-removal technique.

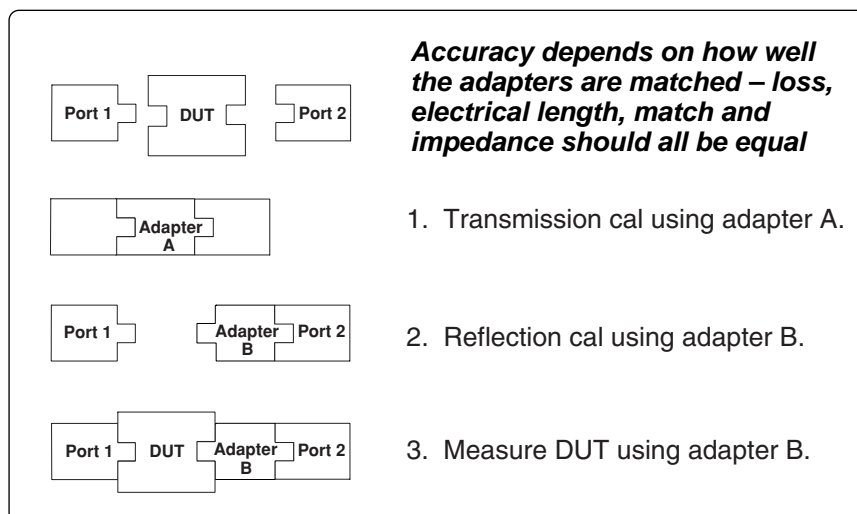

Figure 15. Swap-Equal-Adapters Method

Adapter-Removal Calibration

Adapter-removal calibration provides the most complete and accurate calibration procedure for noninsertable devices (Figure 16). This method uses a calibration adapter that has the same connectors as the noninsertable DUT. The electrical length of the adapter must be specified within one-quarter wavelength at each calibration frequency. Type-N, 3.5-mm, and 2.4-mm calibration kits for the Agilent 8510 network analyzer contain adapters specified for this purpose.

Two full two-port calibrations are needed for an adapter-removal calibration. In the first calibration, the precision calibration adapter is placed on the analyzer's port 2 and the test results are saved into a calibration set. In the second calibration, the precision calibration adapter is placed on the analyzer's port 1 and the test data is saved into a second calibration set.

Pressing the adapter-removal calibration softkey causes the network analyzer to use the two sets of calibration data to generate a new set of error coefficients that remove the effects of the calibration adapter. At this point, the adapter can be removed and the vector analyzer is ready to measure the DUT.

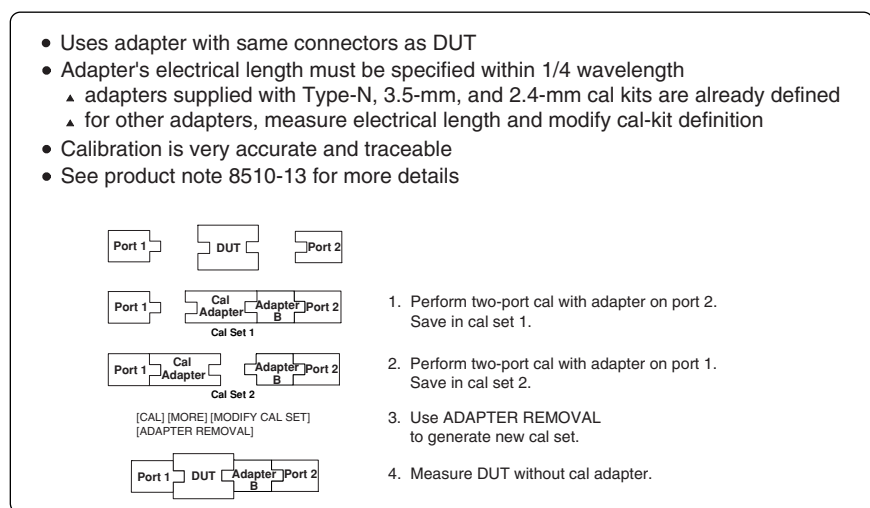

Figure 16. Adapter-Removal Calibration

Suggested Reading

Understanding the Fundamental Principles of Vector Network Analysis, Agilent application note 1287-1.

Exploring the Architectures of Network Analyzers, Agilent application note 1287-2.

Network Analyzer Measurements: Filter and Amplifier Examples, Agilent application note 1287-4.

Specifying Calibration Standards for the Agilent 8510 Network Analyzer, Agilent product note 8510-5A.

Applying the Agilent 8510 TRL Calibration for Non-Coaxial Measurements, Agilent product note 8510-8A.

By internet, phone, or fax, get assistance with all your test and measurement needs.

Online Assistance

www.agilent.com/find/assist

Phone or Fax

United States:

(tel) 1 800 452 4844

Canada:

(tel) 1 877 894 4414

(fax) (905) 206 4120

Europe:

(tel) (31 20) 547 2323

(fax) (31 20) 547 2390

Japan:

(tel) (81) 426 56 7832

(fax) (81) 426 56 7840

Latin America:

(tel) (305) 269 7500

(fax) (305) 269 7599

Australia:

(tel) 1 800 629 485

(fax) (61 3) 9210 5947

New Zealand:

(tel) 0 800 738 378

(fax) (64 4) 495 8950

Asia Pacific:

(tel) (852) 3197 7777

(fax) (852) 2506 9284

Product specifications and descriptions in this document subject to change without notice.

Copyright © 1997, 2000 Agilent Technologies

Printed in U.S.A. July 25, 2001

5965-7709E



Agilent Technologies

Innovating the HP Way